

Sioux Chief CPVC Fittings

- The widest line of transition fittings in the industry.
- Compatible with FlowGuard Gold® pipe and fittings. FGG/BM/CZ® System compatible. Standard solvent weld socket connection.
- Makes CPVC to fixture connections faster, easier and more durable than other transition fittings.
- All fittings are 100% production tested to ensure maximum quality and a leak free connection.
- Hydrostatic pressure tested to over 500 PSI without leaks.
- Thermal cycle tested up to 180°F for 1000 cycles.

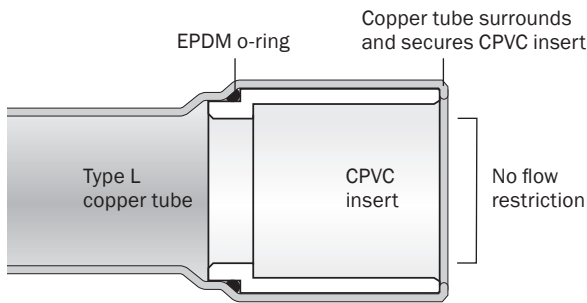

Important Notes about Sioux Chief CPVC Fittings

- All Sioux Chief CPVC fittings conform to ASTM D2846 Standard for CPVC piping systems and are designed for use with any CPVC pipe and fittings conforming to ASTM D2846. A select group of our transition fittings have been tested and certified by CSA to the ASTM D2846 Standard and CSA Standard B137.6 and/or listed by UPC.
- Do not cut, alter or modify any Sioux Chief CPVC transition fitting. Doing so voids the manufacturer's warranty. The only exception is for the 630-C series (p 54) where the spin closed end must be cut off.
- Do not expose CPVC transition area of fitting to heat in excess of 190°F. Excessive heat will distort and deform the CPVC insert and damage the internal o-ring seal. Never install a damaged fitting.
- Perform all solder joints on Sioux Chief ½" and ¾" CPVC transition fittings at a minimum distance of 10" along copper tube from the CPVC transition area. For 1"-2" CPVC transition fittings, temporarily plug CPVC socket with a nipple and cap. Perform all solder joints on Sioux Chief 1"-2" CPVC transition fittings a minimum distance of 18" along the copper tube. If a heat blocker is used, soldering distance may be reduced to 6" for ½" and ¾" CPVC transition fittings and 15" for 1" CPVC transition fittings.



FGG/BM/CZ® System Compatible indicates this product has been tested and is monitored on an ongoing basis to assure chemical compatibility with FlowGuard Gold®, BlazeMaster®, and Corzan® pipe and fittings. FGG/BM/CZ®, FlowGuard Gold®, BlazeMaster® and Corzan® are registered trademarks of Noveon IP Holdings Corp.



SUPPLY
DRAINAGE
SUPPORT
TESTING
SPECIALTIES
TOOLS
ACCESS

SUPPLY



630-C248

DRAINAGE

SUPPORT

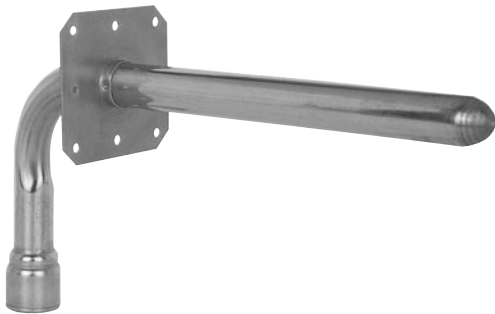

630-C248E

Stub Out Elbow

Standard Square-O Strap

- Accepts sweat and compression stop valves
- Combines the easy installation of CPVC with the strength and versatility of copper
- Spin closed ends are guaranteed leakproof
- Type L copper
- Square O Strap is crimped onto tube

TESTING

Use Caution When Soldering

Keep the following minimum distances between CPVC joints and solder joints:

Tube Size	No Heat Blocker	With Heat Blocker
1/2" CTS	10"	6"
3/4" CTS	10"	6"
1" CTS	18"	15"

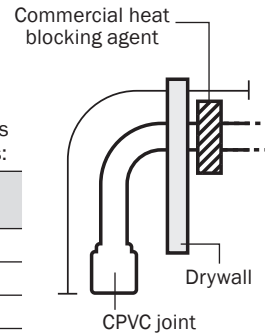

SPECIALTIES



Stub out elbows combine elbow and cap in one quick, easy stub out fitting.

TOOLS

Guaranteed Leakproof

Spin closed ends have **five** times the wall thickness of the copper tube. Each fitting is factory inspected.

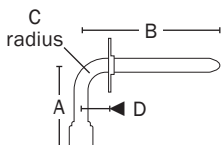

NEW



ACCESS

Item No.	Connection	Dimensions				Pkg	Min. Qty	Case Qty	List Price
		A	B	C	D				
STANDARD									
630-C248	1/2" CPVC socket	3 1/2"	8"	1 1/4"	—	B	50	50	5.64 EA
630-C248PK	1/2" CPVC socket	3 1/2"	8"	1 1/4"	—	C*	10	10	5.79 EA
630-C2412	1/2" CPVC socket	3 1/2"	12"	1 1/4"	—	B	50	50	8.06 EA
630-C287	1/2" CPVC socket	8"	7"	1 1/4"	—	B	50	50	7.30 EA
630-C348	3/4" CPVC socket	6"	8"	1 3/4"	—	B	50	50	10.67 EA
630-C3612	3/4" CPVC socket	6"	12"	1 3/4"	—	B	25	25	14.22 EA
630-C41110	1" CPVC socket	11"	10"	2"	—	B	25	25	22.37 EA
WITH SQUARE O STRAP									
630-C248E	1/2" CPVC socket	3 1/2"	8"	1 1/4"	1 3/4"	B	25	25	6.39 EA
630-C4110E	1" CPVC socket	11"	10"	2"	2"	B	10	10	23.37 EA

Tub/Shower Pressure Connector

- Long radius bend for better flow and less noise
- One piece, type L copper
- MIP and FIP swivel connections mean no more torch at the tub/shower valve

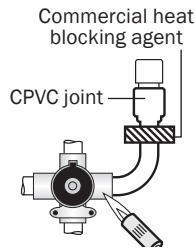

Use Caution When Soldering

Whenever possible, solder with CPVC socket facing downward. If CPVC joint is above solder joint, plug temporarily with nipple and cap to prevent chimney effect. Always apply torch to valve, not to the fitting. Use a commercial heat blocking agent between solder joint and CPVC joint.

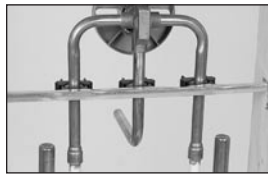

Item No.	Connection	Dimensions		Pkg	Min. Qty	Case Qty	List Price
		A	B				
632-C263	1/2" CPVC socket x 1/2" male sweat elbow	6"	2 1/4"	B	50	50	4.69 EA
632-C263PK	1/2" CPVC socket x 1/2" male sweat elbow	6"	2 1/4"	C*	10	10	4.84 EA
632-C283	1/2" CPVC socket x 1/2" male sweat elbow	8"	2 1/4"	B	50	50	5.23 EA
632-C283PK	1/2" CPVC socket x 1/2" male sweat elbow	8"	2 1/4"	C*	10	10	5.38 EA
632-C2123	1/2" CPVC socket x 1/2" male sweat elbow	12"	2 1/4"	B	50	50	7.01 EA
632-C263X	1/2" CPVC socket x 1/2" MIP swivel elbow	6"	3"	B	50	50	7.35 EA
632-C263Y	1/2" CPVC socket x 1/2" FIP swivel elbow	6"	3"	B	50	50	6.14 EA

DO NOT use pipe dope on FIP threads

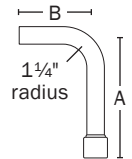

Tub/Shower Elbow

Shower-Lock & Drop-Ear Models

- Forged brass, 1/2" FIP thread body with CPVC connection
- Lead-free solder joint
- Shower-lock models for applications with wallboard or fiberglass shower units
- Internal FIP threads accept shower arms or tub nipples

Related Products

Shower WallNut

p 272



Item No.	Description	Pkg	Min. Qty	Case Qty	List Price
616-C2	1/2" CPVC x 1/2" FIP shower-lock elbow with 2" O.D. lock nuts	B	50	50	12.49 EA
616-C2PK	1/2" CPVC x 1/2" FIP shower-lock elbow with 2" O.D. lock nuts	C*	10	10	12.63 EA
647-C2E	1/2" CPVC x 1/2" FIP drop-ear elbow	B	50	50	7.13 EA
647-C2EPK2	1/2" CPVC x 1/2" FIP drop-ear elbow	C*	10	10	7.31 EA
NEW 647-C3E	3/4" CPVC x 3/4" FIP drop-ear elbow	B	1	1	13.92 EA
NEW 647-C4E	1" CPVC x 1" FIP drop-ear elbow	B	1	1	19.82 EA



SUPPLY

DRAINAGE

SUPPORT

TESTING

SPECIALTIES

TOOLS

ACCESS

Water Heater Connector

FIP Elbow Fitting

- Full-flow fitting
- Brass FIP swivel nut with gasket is a dielectric fitting
- Fitting with 600 WOG full port ball valve available

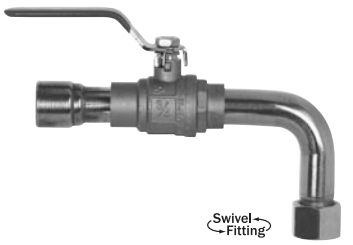

631-C307FP



631-C307

DO NOT use pipe dope on FIP threads



Item No.	Kit Code	Connection	Length	Ball Valve	Pkg	Min. Qty	Case Qty	List Price
631-C307	06	3/4" FIP swivel x 3/4" CPVC socket	3" x 7"		B	25	25	12.57 EA
631-C307FP	01	3/4" FIP swivel x 3/4" CPVC socket	3" x 7"	✓	B	25	25	27.99 EA

Water Heater Connector

FIP Straight Fitting

- Full-flow fitting
- Brass FIP swivel nut with gasket is a dielectric fitting
- Fitting with 600 WOG full port ball valve available
- 3/4" FIP branch for two gallon expansion tank



633-C18FPT

633-C18

DO NOT use pipe dope on FIP threads



Item No.	Kit Code	Connection	Length	Ball Valve	Pkg	Min. Qty	Case Qty	List Price
633-C02	31	3/4" FIP swivel x 3/4" CPVC socket	3"		B	50	50	6.62 EA
633-C02PK	—	3/4" FIP swivel x 3/4" CPVC socket	3"		C*	10	10	6.76 EA
633-C09	32	3/4" FIP swivel x 3/4" CPVC socket	9"		B	25	25	11.39 EA
633-C18	33	3/4" FIP swivel x 3/4" CPVC socket	18"		B	25	25	14.71 EA
633-C18PK	—	3/4" FIP swivel x 3/4" CPVC socket	18"		C*	10	10	15.08 EA
633-C24	35	3/4" FIP swivel x 3/4" CPVC socket	24"		B	25	25	18.37 EA
633-C418	36	1" FIP swivel x 3/4" CPVC socket	18"		B	25	25	23.06 EA
633-C424	37	1" FIP swivel x 3/4" CPVC socket	24"		B	25	25	27.52 EA
633-C09FP	11	3/4" FIP swivel x 3/4" CPVC socket	9"	✓	B	25	25	26.49 EA
633-C18FP	12	3/4" FIP swivel x 3/4" CPVC socket	18"	✓	B	25	25	31.78 EA
633-C24FP	14	3/4" FIP swivel x 3/4" CPVC socket	24"	✓	B	25	25	34.38 EA
633-C418FP	15	1" FIP swivel x 3/4" CPVC socket	18"	✓	B	25	25	38.45 EA
633-C424FP	16	1" FIP swivel x 3/4" CPVC socket	24"	✓	B	25	25	41.47 EA
633-C18M3	34	3/4" FIP swivel x 3/4" CPVC socket, with 3/4" MIP branch	18"		B	25	25	24.77 EA
633-C18FPM3	13	3/4" FIP swivel x 3/4" CPVC socket, with 3/4" MIP branch	18"	✓	B	25	25	42.15 EA
633-C18FPT	21	3/4" FIP swivel x 3/4" CPVC socket, with 3/4" FIP branch	18"	✓	B	20	20	45.67 EA
633-C18FRV	17	3/4" FIP swivel x 3/4" CPVC socket, with pressure relief 3/8" O.D. compression	18"	✓	B	10	10	73.69 EA
633-C418FRV	25	1" FIP swivel x 3/4" CPVC socket, with pressure relief 3/8" O.D. compression	18"	✓	B	10	10	77.14 EA

Water Heater Connector

FIP Flexible Fitting

- Full-flow fitting
- FIP swivel nut with gasket is a dielectric fitting
- Fitting with 600 WOG full port ball valve available



DO NOT use pipe dope on FIP threads

Item No.	Kit Code	Connection	Length	Ball Valve	Pkg	Min. Qty	Case Qty	List Price
634-C118	56	3/4" FIP swivel x 3/4" CPVC socket	18"		B	25	25	20.27 EA
634-C118FP	51	3/4" FIP swivel x 3/4" CPVC socket	18"	✓	B	25	25	27.41 EA



Water Heater Connector

MIP Straight Fitting

- Full-flow fitting
- 3/4" FIP branch for two gallon expansion tank
- Fitting with 600 WOG full port ball valve available



Item No.	Kit Code	Connection	Length	Ball Valve	Pkg	Min. Qty	Case Qty	List Price
646-C3	71	3/4" MIP x 3/4" CPVC socket	3 1/4"		B	50	50	5.50 EA
646-C3PK	—	3/4" MIP x 3/4" CPVC socket	3 1/4"		C*	10	10	5.68 EA
646-C309	76	3/4" MIP x 3/4" CPVC socket	9"		B	25	25	10.85 EA
646-C318	72	3/4" MIP x 3/4" CPVC socket	18"		B	25	25	14.84 EA
646-C318PK	—	3/4" MIP x 3/4" CPVC socket	18"		C*	10	10	15.02 EA
646-C324	73	3/4" MIP x 3/4" CPVC socket	24"		B	25	25	19.44 EA
646-C3418	74	1" MIP x 3/4" CPVC socket	18"		B	25	25	17.93 EA
646-C3424	75	1" MIP x 3/4" CPVC socket	24"		B	25	25	21.41 EA
646-C309FP	66	3/4" MIP x 3/4" CPVC socket	9"	✓	B	25	25	22.60 EA
646-C318FP	61	3/4" MIP x 3/4" CPVC socket	18"	✓	B	25	25	30.55 EA
646-C318FPPK	—	3/4" MIP x 3/4" CPVC socket	18"	✓	C*	10	10	30.71 EA
646-C324FP	63	3/4" MIP x 3/4" CPVC socket	24"	✓	B	25	25	33.58 EA
646-C3418FP	64	1" MIP x 3/4" CPVC socket	18"	✓	B	25	25	34.79 EA
646-C3424FP	65	1" MIP x 3/4" CPVC socket	24"	✓	B	25	25	37.58 EA
646-C318FPT	81	3/4" MIP x 3/4" CPVC socket, with 3/4" FIP branch	18"	✓	B	20	20	45.87 EA
646-C324FPT	82	3/4" MIP x 3/4" CPVC socket, with 3/4" FIP branch	24"	✓	B	20	20	48.82 EA



SUPPLY
DRAINAGE
SUPPORT
TESTING
SPECIALTIES
TOOLS
ACCESS

SUPPLY

DRAINAGE

SUPPORT

TESTING

SPECIALTIES

TOOLS

ACCESS

Wal-Let™

Wall Termination Fitting

- Perfect for connecting sillcocks to CPVC systems
- One-piece, forged brass fitting with rigid mounting plate soldered to copper elbow with lead-free solder



Item No.	Description	Pkg	Min. Qty	Case Qty	List Price
615-C263	1/2" CPVC x 1/2" FIP, 6" x 3" elbow	B	25	25	15.53 EA
615-C264	1/2" CPVC x 1/2" MIP, 6" x 3" elbow	B	25	25	15.33 EA
615-C2113	1/2" CPVC x 1/2" MSWT, 11" straight	B	25	25	17.71 EA

Adapter

Sillcock Adapter

- Perfect for connecting sillcocks to CPVC systems
- Lead-free solder joint



Item No.	Description	Length	Pkg	Min. Qty	Case Qty	List Price
647-C2D	1/2" CPVC x 1/2" FIP drop-ear	2 1/2"	B	50	50	14.03 EA
647-C2DPK2	1/2" CPVC x 1/2" FIP drop-ear, 1/bag	2 1/2"	C*	10	10	14.23 BG
647-C2DW	1/2" CPVC x 1/2" FIP wing-ear	2 5/8"	B	50	50	13.68 EA
647-C2DWPK2	1/2" CPVC x 1/2" FIP wing-ear, 1/bag	2 5/8"	C*	10	10	13.85 EA

Short-N-Swivel™

FIP x CPVC Swivel Adapter

- Incredibly versatile and affordable fitting
- One will take the place of up to three expensive union adapters
- Brass swivel nut includes gasket making it a dielectric fitting



3/4" Short-N-Swivel is perfect for hooking up electric water heaters.

DO NOT use pipe dope on FIP threads



Item No.	Connection	Length	Pkg	Min. Qty	Case Qty	List Price
637-C20	1/2" CPVC x 1/2" FIP swivel	2"	B	25	25	5.02 EA
637-C20PK2	1/2" CPVC x 1/2" FIP swivel	2"	C*	10	10	5.21 EA
633-C02	3/4" CPVC x 3/4" FIP swivel	3"	B	50	50	6.62 EA
633-C02PK	3/4" CPVC x 3/4" FIP swivel	3"	C*	10	10	6.76 EA
633-C4403	1" CPVC x 1" FIP swivel	3 1/8"	B	20	20	16.71 EA

Adapter

- MIP × CPVC
- FIP × CPVC
- F 1807 PEX Crimp x CPVC
- F 1960 PEX Cold Expansion x CPVC
- PB × CPVC

• Lead-free solder joint



646-C2



647-C2



645WC2



645XC2



645-C2G

Item No.	Connection	Length	Pkg	Min. Qty	Case Qty	List Price
MIP						
646-C2	1/2" CPVC × 1/2" MIP	2 1/2"	B	50	50	4.40 EA
646-C2PK2	1/2" CPVC × 1/2" MIP	2 1/2"	C*	10	10	4.58 BG
646-C3	3/4" CPVC × 3/4" MIP	3 1/4"	B	50	50	5.50 EA
646-C3PK2	3/4" CPVC × 3/4" MIP	3 1/4"	C*	10	10	5.68 BG
646-C4	1" CPVC × 1" MIP	3 3/4"	B	20	20	10.79 EA
646-C5	1 1/4" CPVC × 1 1/4" MIP	4 1/4"	B	10	10	38.27 EA
646-C6	1 1/2" CPVC × 1 1/2" MIP	5"	B	10	10	51.34 EA
646-C7	2" CPVC × 2" MIP	6"	B	10	10	79.75 EA
FIP						
647-C2	1/2" CPVC × 1/2" FIP	2 3/4"	B	50	50	4.40 EA
647-C2PK2	1/2" CPVC × 1/2" FIP	2 3/4"	C*	10	10	5.06 BG
647-C3	3/4" CPVC × 3/4" FIP	3 1/4"	B	50	50	5.50 EA
647-C3PK2	3/4" CPVC × 3/4" FIP	3 1/4"	C*	10	10	7.17 BG
647-C4	1" CPVC × 1" FIP	3 3/4"	B	20	20	11.72 EA
647-C5	1 1/4" CPVC × 1 1/4" FIP	4 1/2"	B	10	10	34.75 EA
647-C6	1 1/2" CPVC × 1 1/2" FIP	5 1/4"	B	10	10	47.36 EA
647-C7	2" CPVC × 2" FIP	6"	B	10	10	76.55 EA
F 1807 PEX CRIMP						
645XC2	1/2" CPVC × 1/2" PEX	1 3/8"	B	50	50	4.20 EA
645XC2PK2	1/2" CPVC × 1/2" PEX	1 3/8"	C*	10	10	4.41 BG
645XC3	3/4" CPVC × 3/4" PEX	2 3/8"	B	50	50	4.93 EA
645XC3PK2	3/4" CPVC × 3/4" PEX	2 3/8"	C*	10	10	5.19 BG
645XC4	1" CPVC × 1" PEX	3 3/8"	B	20	20	12.19 EA
F 1960 PEX COLD EXPANSION						
645WC2	1/2" CPVC × 1/2" F1960	1 3/8"	B	50	50	5.83 EA
645WC3	3/4" CPVC × 3/4" F1960	2 3/8"	B	50	50	7.98 EA
645WC4	1" CPVC × 1" F1960	3 3/8"	B	20	20	15.41 EA
PB						
645-C2G	1/2" CPVC × 1/2" PB	2 5/8"	B	50	50	5.46 EA
645-C3G	3/4" CPVC × 3/4" PB	3 1/4"	B	50	50	6.69 EA



SUPPLY

DRAINAGE

SUPPORT

TESTING

SPECIALTIES

TOOLS

ACCESS

Adapter

Male Sweat × CPVC

- Perfect for connecting sillcocks, laundry boxes, water service connections, etc.
- All fittings are production tested to ensure maximum quality and a leak free connection



CAUTION

Do not cut this fitting. Cutting this fitting voids warranty. Do not allow CPVC portion of fitting to be heated. Do not exceed 190°F. Excessive heat can damage the CPVC insert and internal o-ring.



Use Caution When Soldering

Whenever possible, solder with CPVC socket facing downward. If CPVC joint is above solder joint, plug temporarily with nipple and cap to prevent chimney effect.

Always apply torch to female fitting, not to the adapter.

Use a commercial heat blocking agent between solder joint and CPVC joint.

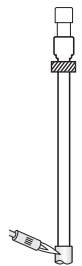

Item No.	Description	Length	Pkg	Min. Qty	Case Qty	List Price
643-C211	1/2" CPVC × 1/2" MSWT	11"	B	100	100	6.69 EA
643-C311	3/4" CPVC × 3/4" MSWT	11"	B	50	50	9.39 EA
643-C418	1" CPVC × 1" MSWT	18"	B	25	25	20.24 EA
NEW 643-C518	1 1/4" CPVC × 1 1/4" MSWT	18"	B	1	1	38.78 EA
NEW 643-C620	1 1/2" CPVC × 1 1/2" MSWT	20"	B	1	1	52.06 EA
NEW 643-C722	2" CPVC × 2" MSWT	22"	B	1	1	78.43 EA

Brass Ball Valve

- Chrome plated ball, blowout-proof stem
- Lead-free solder joint
- ANSI/NSF 61-8
- C-377 forged brass



Item No.	Connection	Length	Pkg	Min. Qty	Case Qty	List Price
FULL PORT						
648-C2FP	1/2" CPVC	4 1/2"	B	10	10	15.79 EA
648-C2FPPK	1/2" CPVC	4 1/2"	C*	10	10	15.92 EA
648-C3FP	3/4" CPVC	6"	B	10	10	20.07 EA
648-C4FP	1" CPVC	8"	B	10	10	39.72 EA
FULL PORT WITH DRAIN						
648-C2FPD	1/2" CPVC	4 1/2"	B	10	10	18.88 EA
648-C3FPD	3/4" CPVC	6"	B	10	10	28.25 EA
648-C4FPD	1" CPVC	8"	B	10	10	47.65 EA



Fitting ends only

Thermoplastic CPVC Ball Valve

- NSF/ANSI 14
- ASTM D2846 socket joint
- Teflon seat
- EPDM o-rings
- Rated 100 PSI at 180° F



Item No.	Connection	Pkg	Min. Qty	Case Qty	List Price
106-C22	1/2" CPVC	B	10	100	5.60 EA
106-C23	3/4" CPVC	B	10	100	7.50 EA
106-C24	1" CPVC	B	10	100	11.99 EA

Brass Stop & Waste Valve

- Brass valve body with stuffing box, neoprene seals
- Lead-free solder joint
- ANSI/NSF 61-8



Item No.	Connection	Length	Pkg	Min. Qty	Case Qty	List Price
648-C2W	1/2" CPVC	4 3/8"	B	10	10	15.71 EA
648-C3W	3/4" CPVC	6 1/8"	B	10	10	17.51 EA

FGG -BM- CZ
SYSTEM COMPATIBLE



Brass Boiler Drain

- Male hose thread spout
- With stuffing box
- Lead-free solder joint
- ANSI/NSF 61-8

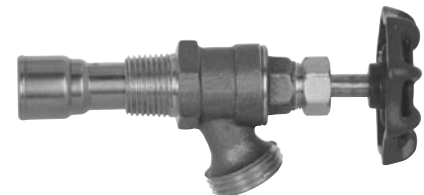

Item No.	Connection	Pkg	Min. Qty	Case Qty	List Price
113-C32	1/2" CPVC	B	25	25	11.76 EA

FGG -BM- CZ
SYSTEM COMPATIBLE



SUPPLY

DRAINAGE

SUPPORT

TESTING

SPECIALTIES

TOOLS

ACCESS

Silcock

Standard

- New larger 2 1/8" dia. mounting flange
- Lead-free solder joint

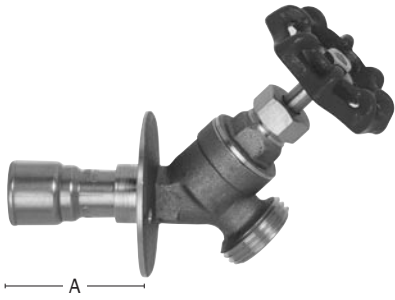

Item No.	Connection	Dimensions A	Pkg	Min. Qty	Case Qty	List Price
117-C22	1/2" CPVC	1 5/8"	B	25	25	13.43 EA
117-C223E	1/2" CPVC	3 5/16"	B	25	25	14.08 EA

NEW Frost-Proof Silcock

Standard

- Longer stem keeps knuckles from scraping on hose threads
- Thicker, easier turning handle
- Nickel plated brass body with black metal handle



1/4-Turn

- Extended tailpiece for ease of installation
- Extra-large mounting flange
- Spout alignment feature
- Nickel plated brass body



Item No.	Connection	Length	Pkg	Min. Qty	Case Qty	List Price
STANDARD						
118-C208	1/2" CPVC	8"	B	5	5	32.42 EA
118-C210	1/2" CPVC	10"	B	5	5	33.07 EA
1/4-TURN						
119-C208	1/2" CPVC	8"	B	5	5	37.97 EA
119-C210	1/2" CPVC	10"	B	5	5	39.55 EA