



This manual covers the following models:

- **T905**

## Thermostat Applications Guide

Description	
Gas or Oil Heat	Yes
Electric Furnace	Yes
Heat Pump (No Aux. or Emergency Heat)	Yes
Heat Pump (with Aux. or Emergency Heat)	No
Multi-stage Systems	No
Heat Only Systems	Yes
Cool Only Systems	Yes
Millivolt	Yes

## Power Type

- Battery Power
- Hardwire (Common Wire)
- Hardwire (Common Wire) with Battery Backup

## Table of Contents

	Page
Installation Tips	2
Thermostat Quick Reference	3
Subbase Installation	4
Wiring	5
Wiring Diagrams	6
Technician Setup Menu	7-9
Mounting and Battery Installation	10
Programming The Thermostat	11-13
Specifications	14

**A trained, experienced technician must install this product.**

Carefully read these instructions. You could damage this product or cause a hazardous condition if you fail to follow these instructions.

**Need Help?**

For assistance with this product please visit <http://www.pro1iaq.com> or call Pro1 Customer Care toll-free at 888-Pro1iaq (776-1427) during normal business hours (Mon-Fri 9 AM - 6 PM Eastern)

Una versión española de este manual puede ser descargada en [www.pro1iaq.com](http://www.pro1iaq.com)

## Wall locations

The thermostat should be installed approximately 4 to 5 feet above the floor. Select an area with average temperature and good air circulation.

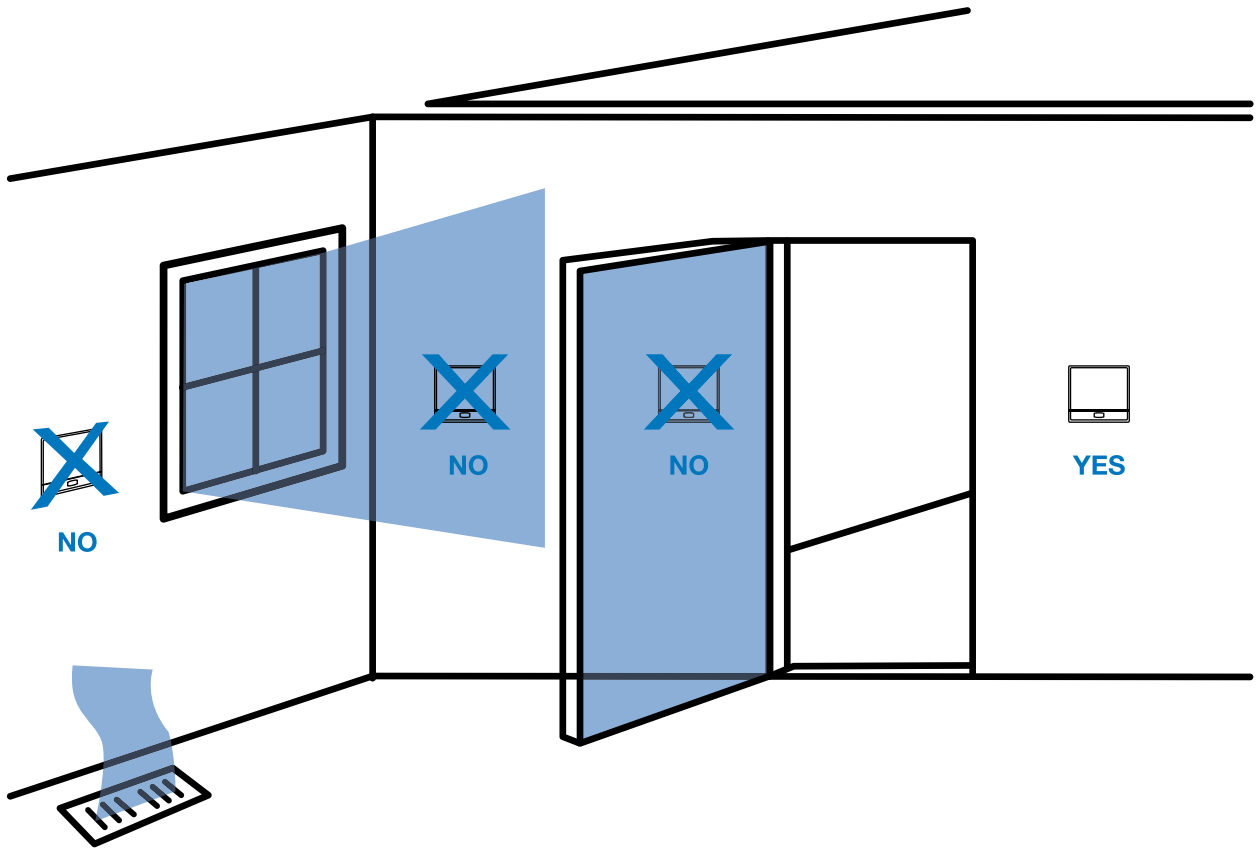

**Do not install** thermostat in locations:

- Close to hot or cold air ducts
- That are in direct sunlight
- With an outside wall behind the thermostat
- In areas that do not require conditioning
- Where there are dead spots or drafts (in corners or behind doors)
- Where there might be concealed chimneys or pipes
- Where appliances could radiate heat

## PRO1 Tip

Pick an installation location that is easy for the user to access. The temperature of the location should be representative of the building.

# INSTALLATION MANUAL THERMOSTAT QUICK REFERENCE

## Getting to know your thermostat



- ② **Glow in the Dark Light Button**
- ③ **Fan Button**
- ④ **System Button**
- ⑤ **Temperature Setpoint Buttons**
- ⑥ **Menu Button**



### Important:

The low battery indicator is displayed when the AA battery power is low. If the user fails to replace the battery within 21 days, the thermostat display will only show the low battery indicator as a final warning before the thermostat becomes inoperable. The batteries are located on the back of the thermostat.

### ① LCD

**Days of the week and time**: Displays the user selectable setpoint temperature.

**Indicates the current room temperature.**

**Displays the user selectable setpoint temperature.**

**Low Battery Indicator:** Replace batteries when this indicator is shown.

**Programmable Time Period Icons:** This thermostat has 4 programmable time periods per day.

**Clean Display:** Pressing **CLEAN DISPLAY** will allow 30 seconds to clean the display. The keys will be inoperable during this time. **CLEAN** will appear if your contractor has programmed a filter change reminder. Press **CLEAN** when filter has been replaced to reset the filter change reminder timer.

**Program Menu Options** Shows different options during programming.

**HOLD** is displayed when thermostat program is permanently overridden.

**System operation indicators:** The **COOL**, **HEAT** or **FAN** icon will display when the **COOL**, **HEAT** or **FAN** is on.

**NOTE:** The compressor delay feature is active if these icons are flashing. The compressor will not turn on until the 5 minute delay has elapsed.

## Removing the private label badge



Use the bevel on lower ridge

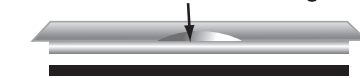

Magnet in door ↑

Gently slide a screwdriver into the bottom edge of the badge. Gently turn the screwdriver counter clockwise. The badge is held on by a magnet. The badge should pry off easily. **Do not use force.**

### PRO1 Tip

All Pro1 thermostats use the same universal magnetic badge. Visit our website at [www.pro1iaq.com](http://www.pro1iaq.com) to learn more about our free private label program.



**Caution:**  
**Electrical Hazard**

Failure to disconnect the power before beginning to install this product can cause electrical shock or equipment damage.



**Mercury Notice:**

All of Pro1's products are mercury free. However, if the product you are replacing contains mercury, dispose of it properly. Your local waste management authority can give you instructions on recycling and proper disposal.

For vertical mount put one screw top and one screw bottom.

For horizontal mount put one screw left and one screw right.

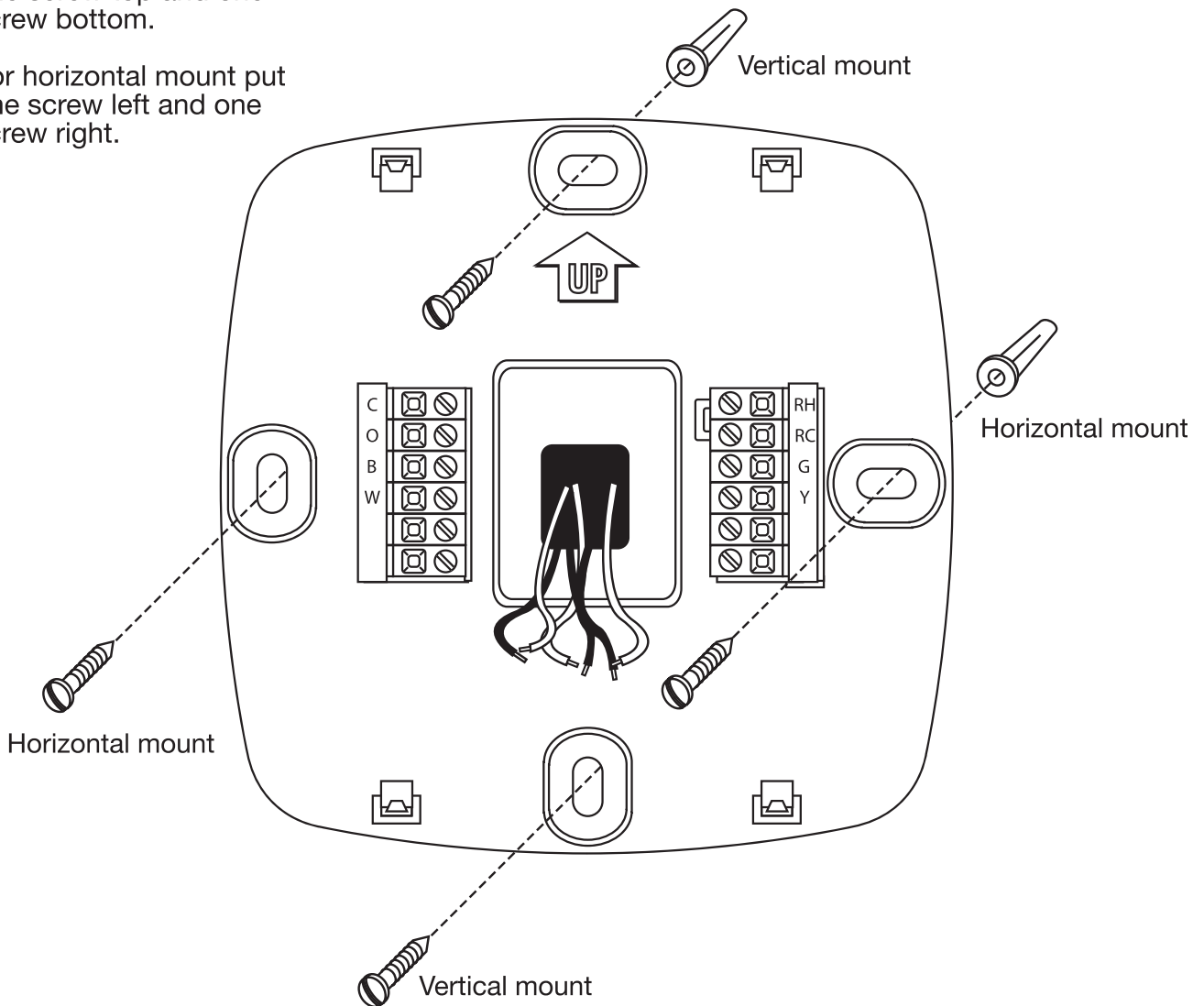



### Caution: Electrical Hazard

Failure to disconnect the power before beginning to install this product can cause electrical shock or equipment damage.



### Warning:

All components of the control system and the thermostat installation must conform to Class II circuits per the NEC Code.

## Wiring

---

1. If you are replacing a thermostat, make note of the terminal connections on the thermostat that is being replaced. In some cases the wiring connections will not be color coded. For example, the green wire may not be connected to the **G** terminal.
2. Loosen the terminal block screws. Insert wires then retighten terminal block screws.
3. Place nonflammable insulation into wall opening to prevent drafts.

## Terminal Designations

---

**W** Heat relay

**Y** Compressor relay

**G** Fan relay

**O** Heat pump changeover valve energized in cooling

**RC** Transformer power for cooling

**RH** Transformer power for heating

**B** Heat pump changeover valve energized in heating

**C** Common wire from secondary side of cooling system transformer or for heat only system transformer

## PRO1 Tips:

---

### RH & RC terminals

For single transformer systems, leave the jumper wire in place between RH and RC. Remove jumper wire for two transformer systems.

### Heat pump systems

If wiring to a heat pump, use a small piece of wire (not supplied) to connect terminals W and Y.

### C terminal

The C (common wire) terminal does not have to be connected when the thermostat is powered by batteries.

### Wire specifications

Use shielded or non-shielded 18 - 22 gauge thermostat wire.

- ▲ 1 Power supply
- ▲ 2 Factory-installed jumper. Remove only when installing on 2-transformer systems.
- ▲ 3 Use either O or B terminals for changeover valve.
- ▲ 4 Use a small piece of wire (not supplied) to connect W and Y terminals.
- ▲ 5 Set fan operation switch to electric
- ▲ 6 Optional 24 VAC common connection when thermostat is used in battery power mode.

## Typical 1H/1C system: 1 transformer

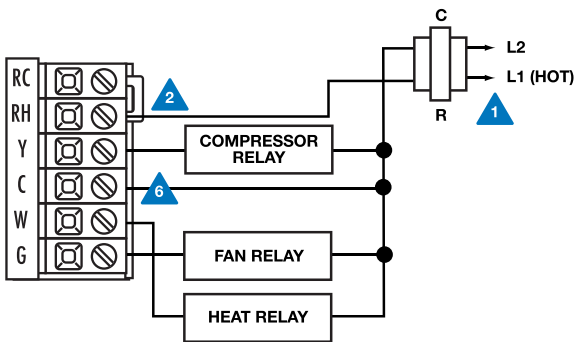

## Typical 1H/1C system: 2 transformer

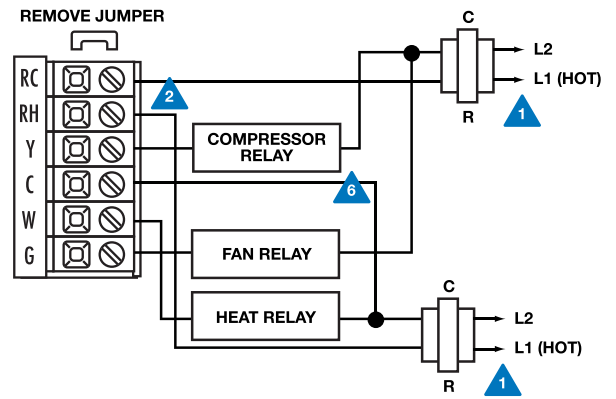

## Typical 1H/1C heat pump system

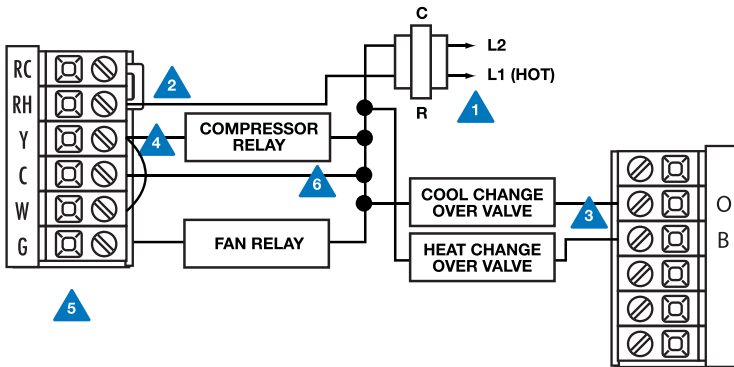

## Typical heat-only system

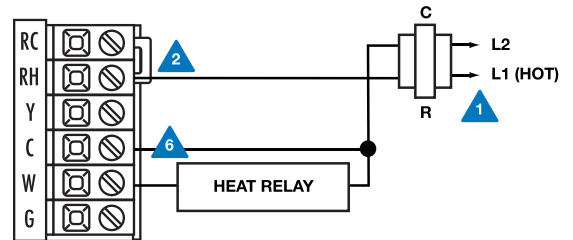

## Typical heat-only system with fan

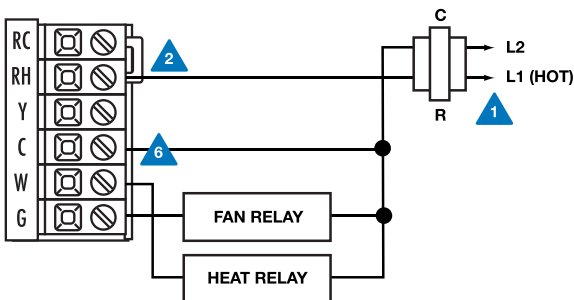

## Typical cool-only system

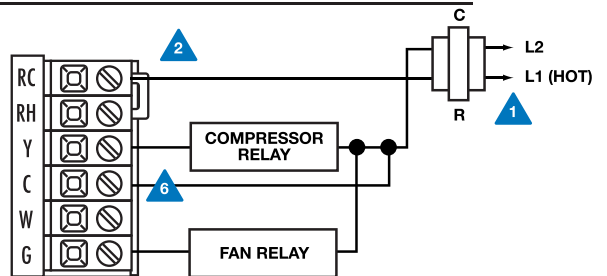











### Technician Setup Menu





This thermostat has a technician setup menu for easy installer configuration. To set up the thermostat for your particular application:

1. Press **MENU** button
2. Press and hold **TECHNICIAN SETUP** button for 3 seconds. This 3 second delay is designed so that homeowners do not accidentally access the installer settings.

3. Configure the installer options as desired using the table below.

Use the  or  keys to change settings and the **NEXT STEP** or **PREVIOUS STEP** key to move from one option to another. **Note:** Only press **DONE** key when you want to exit the Technician Setup options.

Tech Setup Steps						
Filter Change Reminder	Room Temperature Calibration	Minimum Compressor On Time	Compressor Short Cycle Delay	Cooling Swing	Heating Swing	Keypad Lockout
This feature will flash <b>FILT</b> in the display after the elapsed run time to remind the user to change the filter. A setting of <b>OFF</b> will disable this feature.	This feature allows the installer to change the calibration of the room temperature display. For example, if the thermostat reads 70° and you would like it to read 72° then select <b>+2</b> .	This feature allows the installer to select the minimum run time for the compressor. For example, a setting of 4 will force the compressor to run for at least 4 minutes every time the compressor turns on, regardless of the room temperature.	The compressor short cycle delay protects the compressor from "short cycling". This feature will not allow the compressor to be turned on for 5 minutes after it was last turned off.	The swing setting, often called "cycle rate", "differential" or "anticipation" is adjustable. A smaller swing setting will cause more frequent cycles and a larger swing setting will cause fewer cycles.	The swing setting, often called "cycle rate", "differential" or "anticipation" is adjustable. A smaller swing setting will cause more frequent cycles and a larger swing setting will cause fewer cycles.	Keypad lockout allows you to configure the thermostat so that none or some of the keys do not function.
LCD Will Show						
						
Adjustment Options						
You can adjust the filter change reminder from <b>OFF</b> to 2000 hours of runtime in 50 hour increments.	You can adjust the room temperature display to ready -4°F to +4°F above or below the factory calibrated reading.	You can select the minimum compressor run time from "off", "3", "4", or "5" minutes. If 3, 4, or 5 is selected, the compressor will run for at least the selected time before turning off.	Selecting <b>ON</b> will not allow the compressor to be turned on for 5 minutes after the last time the compressor was on. Select <b>OFF</b> to remove this delay.	The cooling swing setting is adjustable from ±0.4°F to ±2°F. For example: A swing setting of 0.5°F will turn the cooling on at approximately 0.5°F above the setpoint and turn the cooling off at approximately 0.5°F below the setpoint.	The heating swing setting is adjustable from ±0.4°F to ±2°F. For example: A swing setting of 0.5°F will turn the heating on at approximately 0.5°F below the setpoint and turn the heating off at approximately 0.5°F above the setpoint.	Pick <b>PA</b> or <b>FU</b>  PA = partial keypad lockout, which locks all the keys except the  or  keys.  FU = Full keypad lockout, which locks out all the keys.  <b>Note:</b> Keypad lockout instructions are below.
Factory Default Settings						
OFF	0 °F	OFF	ON	0.5 °F	0.4 °F	NA







**Note:** To lock the keypad hold down the  and  keys for 3 seconds. You will see a lock in the display. To unlock the keypad hold down the  and  keys for 3 seconds.

TECH SETUP STEPS CONTINUED ON THE NEXT PAGE 

# INSTALLATION MANUAL

## TECHNICIAN SETUP MENU

### Tech Setup Steps (Continued from the previous page)

Heating Temperature Setpoint Limit	Cooling Temperature Setpoint Limit	°F or °C	12 or 24 Hour Clock	Fan Operation	Morning Recovery	Program Options
This feature allows you to set a maximum heat setpoint value. The setpoint temperature cannot be raised above this value.	This feature allows you to set a minimum cool setpoint value. The setpoint temperature cannot be lowered below this value.	Select F for Fahrenheit temperature read out or select C for Celsius read out	You can select either a 12 or 24 hour clock setting.	Select GAS for systems that control the fan during a call for heat. Select ELEC to have the thermostat control the fan during a call for heat.	This feature turns your system on before the WAKE programming time to ensure the environment is at the WAKE setpoint when the WAKE time period begins. This recovery changes over time based on the previous day's experience.	You can configure this thermostat to have a 7 day program, a 5+1+1 program or nonprogrammable.
LCD Will Show						
						
Adjustment Options						
Use the ◀ or ▶ key to select the maximum heat setpoint.	Use the ◀ or ▶ key to select the minimum cool setpoint.	°F for Fahrenheit °C for Celsius	Use the ◀ or ▶ key to select 12 or 24 hour clock.	GAS or ELEC	Use the ◀ or ▶ key to turn on or off.	Use the ◀ or ▶ key to select 7d for 7 day, 5d for 5+1+1, or 0d for nonprogrammable.
Factory Default Settings						
90 °F	44 °F	°F	12 Hour Clock	GAS	ON	5d

TECH SETUP  
STEPS CONTINUED  
ON THE NEXT PAGE



### PRO1 Tip

Temperature swing, sometimes called differential or cycle rate, can be customized for this individual application. For most applications choose a swing setting that is as long as possible without making the occupants uncomfortable.

### Tech Setup Steps (Continued from the previous page)

Display Light	Contractor Call Number	Beep	System Switch
The display light can be configured to come on when any key is pressed or only when the light key is pressed.	Allows you to put your phone number in the display.  Select <b>ON</b> to use this feature then press <b>NEXT STEP</b> .	When any key is pressed an audible beep will sound. There is an <b>ON</b> or an <b>OFF</b> .	You can configure the system switch for the particular application: Heat - Off - Cool, Heat - Off, Cool - Off, Heat - Off - Cool-Auto

### LCD Will Show



### Adjustment Options

<p><b>OFF</b> configures display light to come on only with the light key, which will save battery power.</p> <p><b>ON</b> configures the display light to come on when any key is pressed.</p>	<p>Use the <b>◀</b> or <b>▶</b> key to move from one character to another.</p> <p>Use the <b>▲</b> or <b>▼</b> key to change the flashing character to your desired number.</p>	<p>If <b>ON</b> is selected the beep will sound.</p> <p>If <b>OFF</b> is selected, there is no sound.</p>	<p>Use the <b>◀</b> or <b>▶</b> key until the desired application is flashing.</p>
---	---	---	--

### Factory Default Settings

ON	OFF	ON	Heat - Off - Cool
----	-----	----	-------------------

**Note:** If Contractor Call Number is selected **ON**, your phone number will show in the display if there has been a continuous call for heating or cooling for 24 hours or if the light button is held down for 3 seconds. To remove the phone number from the display, hold the light button down for 3 seconds.

# INSTALLATION MANUAL

## MOUNT THERMOSTAT & BATTERY INSTALLATION

### Mount Thermostat

---

Align the 4 tabs on the subbase with corresponding slots on the back of the thermostat, then push gently until the thermostat snaps in place.



### Battery Installation

---



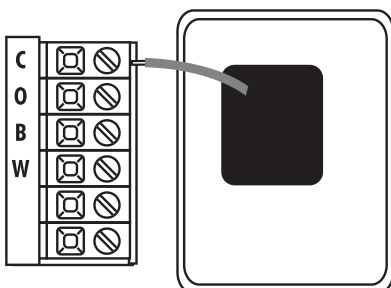



Battery installation is optional if thermostat is hardwired (**C** terminal connected).



On the back of the thermostat insert 2 AA Alkaline batteries (included).

## Set Time













Follow the steps below to set the day of the week and current time:

1. Press **MENU**
2. Press **SET TIME**
3. Day of the week will be flashing. Use the  or  key below the time setting to select the current day of the week.
4. Press **NEXT STEP**
5. The current hour is flashing. Use the  or  key below the time setting to select the current hour. When using 12-hour time, make sure the correct a.m. or p.m. choice is selected.
6. Press **NEXT STEP**
7. Minutes are now flashing. Use the  or  key below the time setting to select current minutes.
8. Press **DONE** when completed

## Programming

All programmable Pro1 thermostats are shipped with an energy saving pre-program. You can customize this default program by following the Set Program Schedule.













Your thermostat can be programmed to have each day of the week programmed uniquely (7 days), all the weekdays the same, a separate program for Saturday, and a separate program for Sunday (5+1+1), or nonprogrammable. There are four time periods for each program (**WAKE, LEAVE, RETURN, SLEEP**). This thermostat has a programmable fan feature, which allows you to run the fan continuously during any time period.

Factory Default Program				
Day of the Week	Events	Time	Setpoint Temperature (Heat)	Setpoint Temperature (Cool)
Weekday	Wake 	6 a.m.	70° F (21° C)	75° F (24° C)
	Leave 	8 a.m.	62° F (17° C)	83° F (28° C)
	Return 	6 p.m.	70° F (21° C)	75° F (24° C)
	Sleep 	10 p.m.	62° F (17° C)	78° F (26° C)
Saturday	Wake 	8 a.m.	70° F (21° C)	75° F (24° C)
	Leave 	10 a.m.	62° F (17° C)	83° F (28° C)
	Return 	6 p.m.	70° F (21° C)	75° F (24° C)
	Sleep 	11 p.m.	62° F (17° C)	78° F (26° C)
Sunday	Wake 	8 a.m.	70° F (21° C)	75° F (24° C)
	Leave 	10 a.m.	62° F (17° C)	83° F (28° C)
	Return 	6 p.m.	70° F (21° C)	75° F (24° C)
	Sleep 	11 p.m.	62° F (17° C)	78° F (26° C)

# INSTALLATION MANUAL

## PROGRAMMING THE THERMOSTAT





You can use the table below to plan your customized program schedule if using 5+1+1.

Programming Table				
Day of the Week	Events	Time	Setpoint Temperature (Heat)	Setpoint Temperature (Cool)
Weekday	Wake 			
	Leave 			
	Return 			
	Sleep 			
Saturday	Wake 			
	Leave 			
	Return 			
	Sleep 			
Sunday	Wake 			
	Leave 			
	Return 			
	Sleep 			

### Set Program Schedule

To customize your 5+1+1 program schedule, follow these steps:

#### Weekday:

1. Select **HEAT** or **COOL** using the **SYSTEM** key.  
**Note:** You have to program heat and cool each separately.
2. Press **MENU**
3. Press **SET SCHEDULE** Note: Monday-Friday is displayed and the **WAKE** icon is shown. You are now programming the **WAKE** time period for the weekday setting.
4. Use the  or  key below the time setting to make your time selection for the weekday **WAKE** time period. Note: If you want the fan to run continuously during this time period, select **ON** with the **FAN** key.
5. Use the  or  temperature setpoint keys on the right side of your screen to make your temperature selection for the weekday **WAKE** period.
6. Press **NEXT STEP**
7. Repeat steps 4 through 6 for weekday **LEAVE** time period, for weekday **RETURN** time period, and for weekday **SLEEP** time period.





#### Saturday:

8. Repeat steps 4 through 6 for Saturday **WAKE** time period, for Saturday **LEAVE** time period, for Saturday **RETURN** time period, and for Saturday **SLEEP** time period.

#### Sunday:

9. Repeat steps 4 through 6 for Sunday **WAKE** time period, for Sunday **LEAVE** time period, for Sunday **RETURN** time period, and for Sunday **SLEEP** time period.

To customize your 7 day program schedule, follow these steps:

1. Select **HEAT** or **COOL** using the **SYSTEM** key. You have to program heat and cool each separately.
2. Press **MENU**
3. Press **SET SCHEDULE**  
**Note:** Monday is displayed and the **WAKE** icon is shown. You are now programming the **WAKE** time period for the Monday setting.
4. Use the  or  key below the time setting to make your time selection for the weekday **WAKE** time period. Note: If you want the fan to run continuously during this time period, select **ON** with the **FAN** key.
5. Use the  or  temperature setpoint keys on the right side of your screen to make your temperature selection for the weekday **WAKE** period.
6. Press **NEXT STEP**
7. Repeat steps 4 thru 6 for Monday **LEAVE** time period, for Monday **RETURN** time period, and for Monday **SLEEP** time period.
8. Repeat steps 4 thru 7 for each of the remaining days in the week.

#### A Note About Auto Changeover:

If in Auto you have the ability to switch between Auto Heat or Auto Cool by pressing the System key. This can be done once the current mode has reached its set-point. For example: if in Auto Heat, the heat setpoint must be satisfied before the thermostat will allow you to switch to Auto Cool. You can switch out of Auto by holding down the System key. To get back into Auto, you must toggle the System key to Auto.

#### A Note About Programmable Fan:

The programmable fan feature will run the fan continuously during any time period it is programmed to be on. This is the best way to keep the air circulated and to eliminate hot & cold spots in your building.

### Specifications

---

The display range of temperature .....	41°F to 95°F (5°C to 35°C)
The control range of temperature .....	44°F to 90°F (7°C to 32°C)
Load rating .....	1 amp per terminal, 1.5 amp maximum all terminals combined
Display accuracy .....	± 1°F
Swing (cycle rate or differential) .....	Heating is adjustable from 0.2°F to 2.0°F Cooling is adjustable from 0.2°F to 2.0°F
Power source .....	18 to 30 VAC, NEC Class II, 50/60 Hz for hardwire (common wire) Battery power from 2 AA Alkaline Energizer batteries
Operating ambient .....	32° to +105° (0° to +41°C)
Operating humidity .....	90% non-condensing maximum
Dimensions of thermostat .....	4.7"W x 4.4"H x 1.1"D

### Contact Us

---

#### **Pro1 IAQ Inc.**

1111 S. Glenstone  
Suite 2-100  
Springfield, MO 65804

**Toll-free:** 1-888-Pro1iaq (776-1427)

**Toll Number (Outside the USA):** 330-821-3600

**Web:** <http://www.pro1iaq.com>

**Hours of Operation:** Monday - Friday 9 AM - 6 PM Eastern