



This manual covers the following models:

- **T855**

## Thermostat Applications Guide

Description	
Gas or Oil Heat	Yes
Electric Furnace	Yes
Heat Pump (No Aux. or Emergency Heat)	Yes
Heat Pump (with Aux. or Emergency Heat)	Yes
Multi-stage Systems	Yes
Heat Only Systems	Yes
Cool Only Systems	Yes
Millivolt	Yes

## Table of Contents

### Page

Installation Tips	2
Thermostat Quick Reference	3
Subbase Installation	4
Wiring	5-6
Mounting and Battery Installation	7
Technician Setup Menu	8-11
Programming	12-15
Specifications	16

Una versión española de este manual puede ser descargada en [www.pro1iaq.com](http://www.pro1iaq.com)

## Power Type

Battery Power  
 Hardwire (Common Wire)  
 Hardwire (Common Wire) with Battery Backup

**A trained, experienced technician must install this product.**

Carefully read these instructions. You could damage this product or cause a hazardous condition if you fail to follow these instructions.

## Need Help?

For assistance with this product please visit <http://www.pro1iaq.com> or call Pro1 Customer Care toll-free at 888-Pro1iaq (776-1427) during normal business hours (Mon-Fri 9 AM - 6 PM Eastern)

### Wall locations

---

The thermostat should be installed approximately 4 to 5 feet above the floor. Select an area with average temperature and good air circulation.

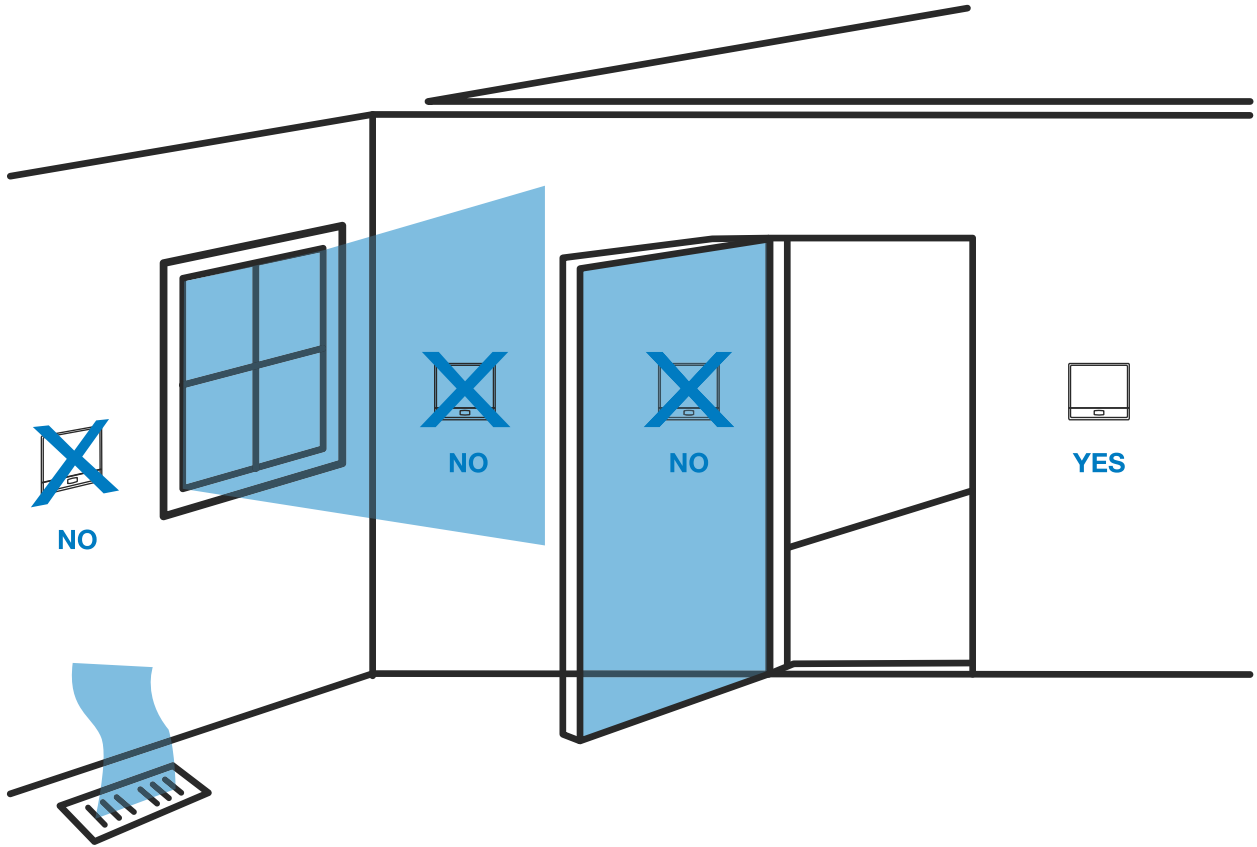

**Do not install** thermostat in locations:

- Close to hot or cold air ducts
- That are in direct sunlight
- With an outside wall behind the thermostat
- In areas that do not require conditioning
- Where there are dead spots or drafts (in corners or behind doors)
- Where there might be concealed chimneys or pipes
- Where appliances could radiate heat

### PRO1 Tip

---

Pick an installation location that is easy for the user to access. The temperature of the location should be representative of the building.

# INSTALLATION MANUAL THERMOSTAT QUICK REFERENCE

## Getting to know your thermostat



Days of the week and time

Indicates the current room temperature.

Displays the user selectable setpoint temperature.

Hold is displayed when thermostat program is permanently overridden.

+1 will appear in the display when second stage of heat or cool is on. +2 will appear for third stage of heat.

**System operation indicators:** The **COOL**, **HEAT** or **FAN** icon will display when the **COOL**, **HEAT** or **FAN** is on. NOTE: The compressor delay feature is active if these icons are flashing. The compressor will not turn on until the 5 minute delay has elapsed.

**Programmable Time Period Icons:** This thermostat can have 2 or 4 programmable time periods per day. Icons are displayed for 4 time periods. Occupied and unoccupied will display in the text field for 2 time periods.

**Program Menu Options:** Shows different options during programming.

**Low Battery Indicator:** Replace batteries when this indicator is shown.

- ① LCD
- ② Glow in the Dark Light Button
- ③ Fan Button
- ④ System Button
- ⑤ Menu Buttons Access Door
- ⑥ Temperature Setpoint Buttons
- ⑦ Menu Button
- ⑧-⑩ User Program Buttons



### Important:

The low battery indicator is displayed when the battery power is low. If the user fails to replace the battery within 21 days, the thermostat display will only show the low battery indicator as a final warning before the thermostat becomes inoperable. For more information, see Battery Installation and Replacement on Page 7.

## Removing the private label badge



Use the bevel on lower ridge

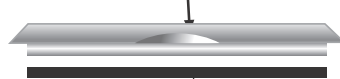

Magnet in door

Gently slide a screwdriver into the bottom edge of the badge. Gently turn the screwdriver counter clockwise. The badge is held on by a magnet. The badge should pry off easily. **Do not use force.**

### PRO1 Tip

All Pro1 thermostats use the same universal magnetic badge. Visit our website at [www.pro1iaq.com](http://www.pro1iaq.com) to learn more about our free private label program.



**Caution:**  
**Electrical Hazard**

Failure to disconnect the power before beginning to install this product can cause electrical shock or equipment damage.



**Caution:**  
**Mercury Notice**

All of PRO1 thermostats are mercury free. However, if the product you are replacing contains mercury, dispose of it properly. Your local waste management authority can give you instructions on recycling and proper disposal.

For vertical mount put one screw top and one screw bottom.

For horizontal mount put one screw left and one screw right.

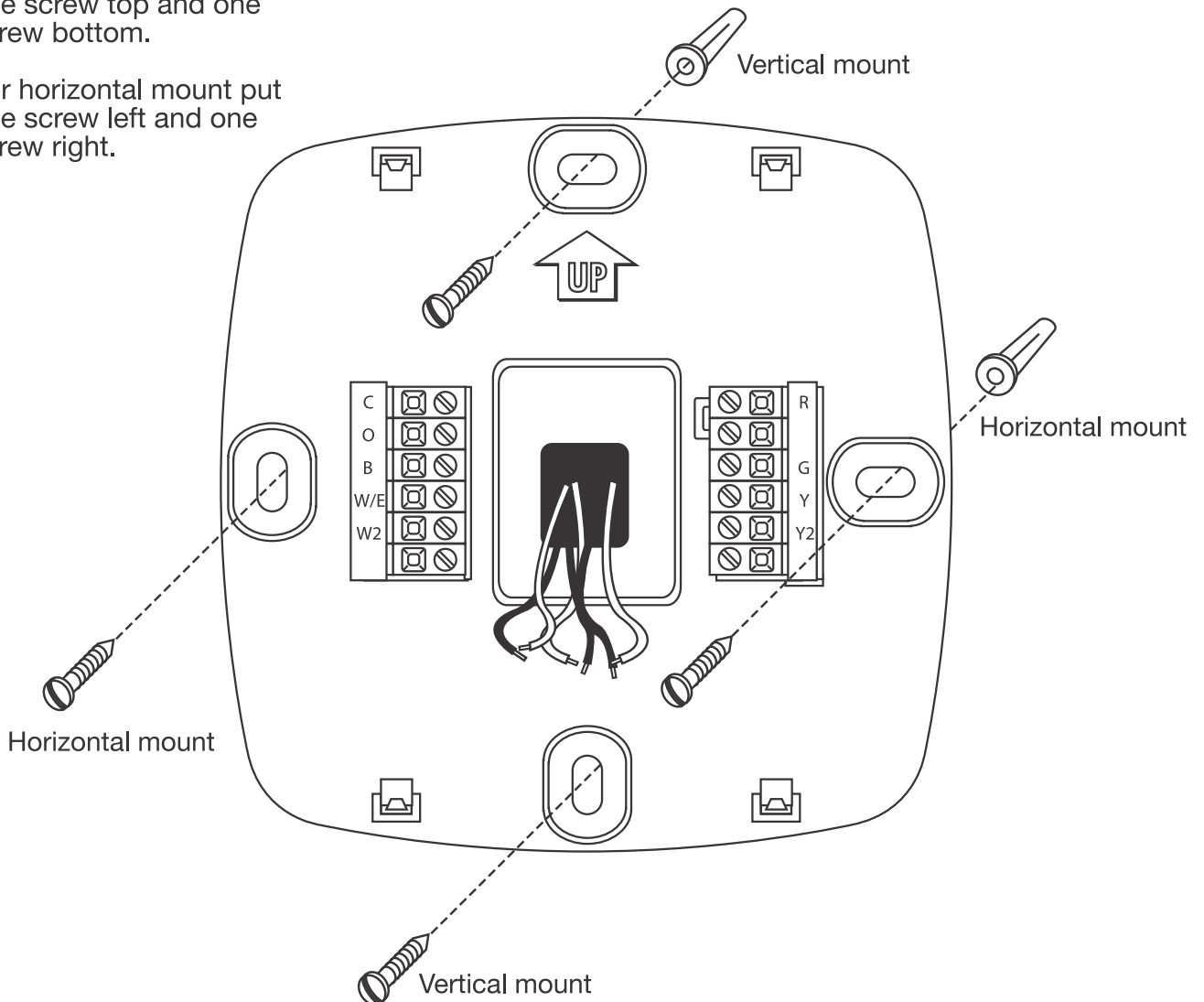

**PRO1 Tip**

Prior to installing subbase place non-flammable insulation into wall opening to prevent drafts.

## New Thermostat Installation Wiring

- ▲ 1 Power supply.
- ▲ 2 Factory-installed jumper. Remove only when installing on 2-transformer systems.
- ▲ 3 Use either O or B terminals for changeover valve.
- ▲ 4 Optional 24 VAC common connection when thermostat is used in battery power mode.

### Typical 2H/2C system: 1 transformer

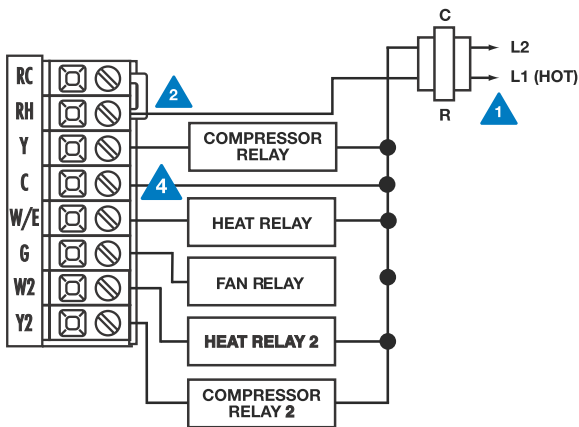

### Typical 2H/2C system: 2 transformer

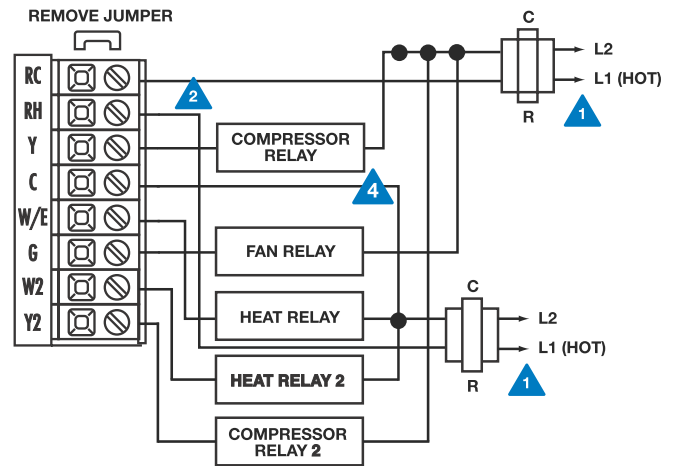

### Typical 3H/2C heat pump system

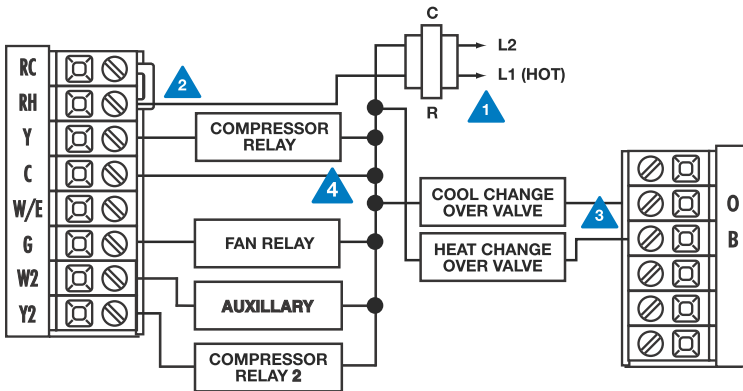

### Typical heat-only system

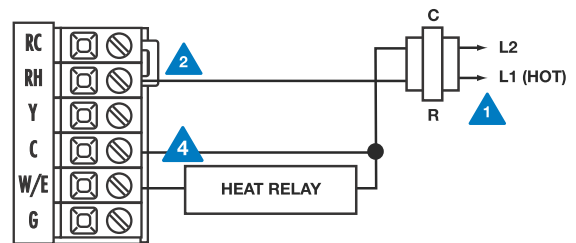

### Typical heat-only system with fan

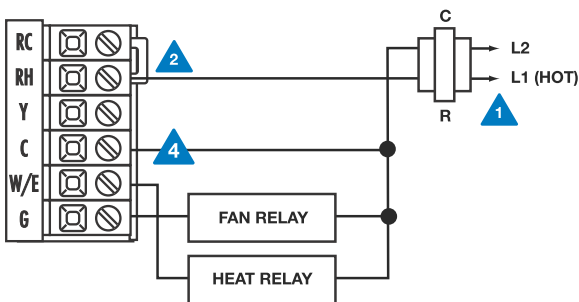

### Typical cool-only system

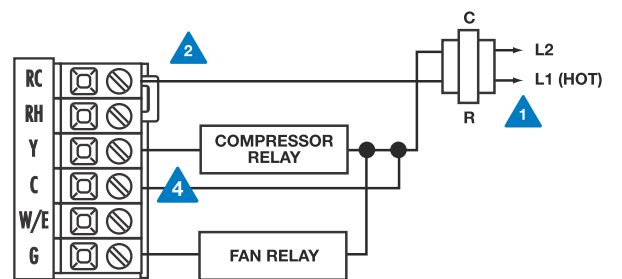

**NOTE:** In many systems with no emergency heat relay a jumper can be installed between E and W2.

## Replacement Thermostat Wiring

1. If you are replacing a thermostat, make note of the terminal connections on the thermostat that is being replaced. In some cases the wiring connections will not be color coded. For example, the green wire may not be connected to the **G** terminal.
2. Loosen the terminal block screws. Insert wires then retighten terminal block screws.



### Warning:

All components of the control system and the thermostat installation must conform to Class II circuits per the NEC Code.

### Wire specifications

Use shielded or non-shielded 18 - 22 gauge thermostat wire.

## Terminal Designations

This thermostat is shipped from the factory to operate a conventional heating and cooling system. The T855 series may be configured for a heat pump system. See the “heat pump” configuration step on page 8 of this manual to configure the thermostat for heat pump applications.

Terminal	2 Heat 2 Cool Conventional System	2 Heat 2 Cool Heat Pump System	3 Heat 2 Cool Heat Pump System
<b>RC</b>	Transformer power (cooling)	Transformer power (cooling)	Transformer power (cooling)
<b>RH</b>	Transformer power (heating)	Transformer power (heating)	Transformer power (heating)
<b>C</b>	Transformer common	Transformer common	Transformer common
<b>B</b>	Energized in heating	Heat pump changeover valve energized in heating	Heat pump changeover valve energized in heating
<b>O</b>	Energized in cooling	Heat pump changeover valve energized in cooling	Heat pump changeover valve energized in cooling
<b>G</b>	Fan relay	Fan relay	Fan relay
<b>W/E</b>	First stage of heat	Emergency heat relay	Emergency heat relay
<b>Y</b>	First stage of cool	First stage of heat & cool	First stage of heat & cool
<b>Y2</b>	Second stage of cool	Second stage of cool	Second stage of cool & second stage of heat
<b>W2</b>	Second stage of heat	Auxiliary heat relay, second stage of heat	Auxiliary heat relay, third stage of heat

## PRO1 Tip

### C terminal

The **C** (common wire) terminal does not have to be connected when the thermostat is powered by batteries.

### Note:

In systems with no emergency heat relay a jumper can be installed between **E** and **W2** to turn thermostat into a single stage control.

# INSTALLATION MANUAL

## MOUNT THERMOSTAT & BATTERY INSTALLATION

### Mount Thermostat

---

Align the 4 tabs on the subbase with corresponding slots on the back of the thermostat, then push gently until the thermostat snaps in place.



### Battery Installation

---

Battery installation is optional if thermostat is hardwired (**C** terminal connected).

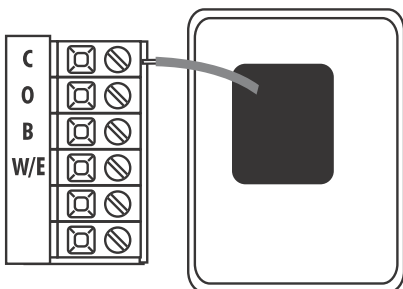

On the back of the thermostat insert 2 AA Alkaline batteries (included).

### Technician Setup Menu

This thermostat has a technician setup menu for easy installer configuration. To set up the thermostat for your particular application:







1. Press **MENU** (7) button
2. Press and hold **TECHNICIAN SETUP** (10) button for 3 seconds. This 3 second delay is designed so that homeowners do not accidentally access the installer settings.

3. Configure the installer options as desired using the table below.

Use the  +  or  -  keys to change settings and the **NEXT STEP** (10) or **PREV STEP** (8) key to move from one option to another.

**Note:** Only press **DONE** (7) key when you want to exit the Technician Setup options.

4. Press **DONE** (7) key to exit

Tech Setup Steps						
Filter Change Reminder	Room Temperature Calibration	Minimum Compressor On Time	Compressor Short Cycle Delay	Cooling Swing	Heating Swing	Keypad Lockout
This feature will flash FILT in the display after the elapsed run time to remind the user to change the filter. A setting of OFF will disable this feature.	This feature allows the installer to change the calibration of the room temperature display. For example, if the thermostat reads 70° and you would like it to read 72° then select +2.	This feature allows the installer to select the minimum run time for the compressor. For example, a setting of 4 will force the compressor to run for at least 4 minutes every time the compressor turns on, regardless of the room temperature.	The compressor short cycle delay protects the compressor from "short cycling". This feature will not allow the compressor to be turned on for 5 minutes after it was last turned off.	The swing setting, often called "cycle rate", "differential" or "anticipation" is adjustable. A smaller swing setting will cause more frequent cycles and a larger swing setting will cause fewer cycles.	The swing setting, often called "cycle rate", "differential" or "anticipation" is adjustable. A smaller swing setting will cause more frequent cycles and a larger swing setting will cause fewer cycles.	Keypad lockout allows you to configure the thermostat so that none or some of the keys do not function.
LCD Will Show						
						
Adjustment Options						
You can adjust the filter change reminder from OFF to 2000 hours of runtime in 50 hour increments.	You can adjust the room temperature display to read -4°F to +4°F above or below the factory calibrated reading.	You can select the minimum compressor run time from "off", "3", "4", or "5" minutes. If 3, 4, or 5 is selected, the compressor will run for at least the selected time before turning off.	Selecting ON will not allow the compressor to be turned on for 5 minutes after the last time the compressor was on. Select OFF to remove this delay.	The cooling swing setting is adjustable from ±0.2°F to ±2°F. For example: A swing setting of 0.5°F will turn the cooling on at approximately 0.5°F above the setpoint and turn the cooling off at approximately 0.5°F below the setpoint.	The heating swing setting is adjustable from ±0.2°F to ±2°F. For example: A swing setting of 0.5°F will turn the heating on at approximately 0.5°F below the setpoint and turn the heating off at approximately 0.5°F above the setpoint.	Pick PA or FU PA = partial keypad lockout, which locks all the keys except the <input type="checkbox"/> + <input type="checkbox"/> or <input type="checkbox"/> - <input type="checkbox"/> keys. FU = Full keypad lockout, which locks out all the keys.  Note: Keypad lockout instructions are below.
Factory Default Settings						
OFF	0 °F	OFF	ON	0.5 °F	0.4 °F	PA

**Note:** To lock the keypad hold down the  +  and  -  keys for 3 seconds. You will see a lock in the display. To unlock the keypad hold down the  +  and  -  keys for 3 seconds.

TECH SETUP  
STEPS CONTINUED  
ON THE NEXT PAGE

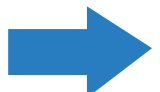

### Tech Setup Steps (Continued from the previous page)

Heating Temperature Setpoint Limit	Cooling Temperature Setpoint Limit	°F or °C	12 or 24 Hour Clock	Fan Operation	Morning Recovery	Program Options	Time Periods
This feature allows you to set a maximum heat setpoint value. The setpoint temperature cannot be raised above this value.	This feature allows you to set a minimum cool setpoint value. The setpoint temperature cannot be lowered below this value.	This feature allows you to display temperatures in either Fahrenheit or Celsius	You can select either a 12 or 24 hour clock setting.	Select GAS for systems that control the fan during a call for heat.  Select ELEC to have the thermostat control the fan during a call for heat.	This feature turns your system on before the WAKE programming time to ensure the environment is at the WAKE setpoint when the WAKE time period begins. The recovery period will change based on previous days knowledge.  For 2 time periods, the system will turn on before the occupied programmable time.	You can configure this thermostat to have a 7 day program, a 5+1+1 program or nonprogrammable.	You can configure this thermostat to have 2 or 4 programmable time periods per day.  2 time periods is Occupied/Unoccupied  4 time periods is Wake, Leave, Return, Sleep.
LCD Will Show							
Adjustment Options							
Use the <b>+</b> or <b>-</b> key to select the maximum heat setpoint. Range 44°F - 90°F	Use the <b>+</b> or <b>-</b> key to select the minimum cool setpoint. Range 44°F - 90°F	Select °F for Fahrenheit or °C for Celsius	Use the <b>+</b> or <b>-</b> key to select 12 or 24 hour clock.	GAS or ELEC	Use the <b>+</b> or <b>-</b> key to turn on or off.	Use the <b>+</b> or <b>-</b> key to select 7d for 7 day, 5d for 5+1+1, or 0d for nonprogrammable.	Use the <b>+</b> or <b>-</b> key to select 2 or 4 time periods per day.
Factory Default Settings							
90 °F	44 °F	°F	12 Hour Clock	GAS	ON	5d	4

TECH SETUP  
STEPS CONTINUED  
ON THE NEXT PAGE



### Tech Setup Steps (Continued from the previous page)

Display Light	Contractor Call Number	Beep	Heat Pump	Operating Modes Selection	Gas Auxiliary for Heat Pump	Stages of Heat	Cooling Fan Delay
<p>The display light can be configured to stay on at all times or come on when any key is pressed.</p> <p><b>NOTE:</b> HARDWIRE ONLY Keeping the display light continually "ON" will greatly reduce battery life.</p>	<p>Allows you to put your phone number in the display.</p> <p>You can choose ON or OFF</p>	<p>When any key is pressed an audible beep will sound.</p> <p>You can choose ON or OFF</p>	<p>When turned on the thermostat will operate a heat pump.</p> <p>1. EM.Heat will show as an option in the system switch.</p> <p>2. Y will be first stage of heat &amp; cool, W/E will be emergency heat relay &amp; W2 will be auxiliary heat relay.</p>	<p>You can configure the system switch for the particular application:</p> <p>Heat - Off - Cool, Heat - Off, Cool - Off, Heat - Off - Cool-Auto</p> <p>Note: EM. Heat will show if in heat pump mode.</p>	<p>This option will turn the heat pump off 45 seconds after the auxiliary heat relay turns on.</p> <p>For 2 stage heat applications, the first stage will turn off 45 seconds after the auxiliary stage turns on.</p> <p>For 3 stage heat applications, the first and second stage will turn off 45 seconds after the auxiliary stage turns on.</p>	<p>You can configure the thermostat to operate a 3 stage heat pump system.</p> <p>2H 2C = 2 heat, 2 cool 3H 2C = 3 heat, 2 cool</p>	<p>The cooling fan delay setting will delay the fan from coming on in cool mode and keep running after the compressor shuts off for a short time to save energy in some systems.</p>

### LCD Will Show



### Adjustment Options

<p>OFF configures display light to come on when the light key or any other key is pressed.</p> <p>ON configures the display light to stay on. Use the <b>+</b> or <b>-</b> key to turn on or off.</p>	<p>If selected on, you will see the input screen after pressing next step.</p> <p>Use the <b>+</b> or <b>-</b> key to select the desired number and the FAN or SYSTEM key to move from one character to another. See note below on operation.</p>	<p>ON is selected the beep will sound.</p> <p>OFF is selected, there is no sound.</p>	<p>OFF configures the thermostat for non heat pump systems</p> <p>ON configures the thermostat for heat pump systems</p>	<p>Use the <b>+</b> or <b>-</b> key until the desired application is flashing.</p>	<p>For heat pump systems that are "dual fuel" (use a gas furnace for auxiliary stage heat) you can turn this feature on to turn off the heat pump when the auxiliary stage of heating has been called for.</p>	<p>Use the <b>+</b> or <b>-</b> key to change between 2 heat and 3 heat.</p> <p>2 heat will use Y1 as first stage and W2 as auxiliary.</p> <p>3 heat will use Y1 as first stage, Y2 as second stage and W2 as auxiliary.</p>	<p>You can select the Cooling Fan Delay from "Off" "15" "30" "60" or "90" seconds. If 15 30 60 or 90 is selected the fan will not turn on for that many seconds when there is a call for cool and will run for that many seconds after satisfying a call for cool.</p>
---	---	---	--	--	--	--	--

### Factory Default Settings

OFF	OFF	ON	OFF	Heat - Off - Cool	OFF	2 Stages	OFF
-----	-----	----	-----	-------------------	-----	----------	-----

### PRO1 Tip

The second stage will turn on at 2x the swing setting. The second stage will turn off when 1x the swing is reached. For example, if the swing setting is .8 degrees for heating and the thermostat is set at 70°F, the first stage will turn on at approximately 69.2°F. The second stage will turn on at 68.4°F. The second stage will turn off at 69.2°F and the first will turn off at 70.8°F. If third stage is used, it will turn on at 3x the swing and turn off at approximately 2x the swing.

TECH SETUP  
STEPS CONTINUED  
ON THE NEXT PAGE



**Note:** If Contractor Call Number is selected ON, your phone number will show in the display if there has been a continuous call for heating or cooling for 24 hours or if the light button is held down for 3 seconds. To remove the phone number from the display, hold the light button down for 3 seconds.

### Tech Setup Steps (Continued from the previous page)

Satisfy Setpoint	Staging Delay
------------------	---------------

This feature allows the thermostat to keep multiple stages of heat or cool energized until setpoint is satisfied.

This feature allows a delay to occur when a second and third stage is needed. This allows the previous stage extra time to satisfy setpoint.

### LCD Will Show

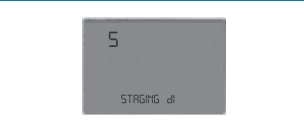
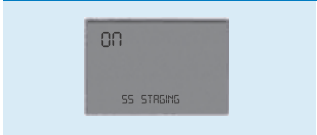

### Adjustment Options

Use the **+** or **-** key to turn on or off.

Use the **+** or **-** key to select OFF, 5, 10, 15, 30, 45, 60, 90.

### Factory Default Settings

OFF

OFF

## Set Time













Follow the steps below to set the day of the week and current time:

1. Press **MENU** (7)
2. Press **SET TIME** (9)
3. Day of the week will be flashing. Use the  or  key to select the current day of the week.
4. Press **NEXT STEP** (10)
5. The current hour is flashing. Use the  or  key to select the current hour. When using 12-hour time, make sure the correct a.m. or p.m. choice is selected.
6. Press **NEXT STEP** (10)
7. Minutes are now flashing. Use the  or  key to select current minutes.
8. Press **DONE** (7) when completed

## Programming













All programmable PRO1 thermostats are shipped with an energy saving pre-program. You can customize this default program by following the Set Program Schedule.

Your thermostat can be programmed to have each day of the week programmed uniquely (7 days), all the weekdays the same, a separate program for Saturday, and a separate program for Sunday (5+1+1), or non-programmable. There can be four time periods for each program (**WAKE, LEAVE, RETURN, SLEEP**), or two time periods for each program (**OCCUPIED, UNOCCUPIED**). This thermostat has a programmable fan feature, which allows you to run the fan continuously during any time period.

Factory Default Program for 4 Time Periods				
Day of the Week	Events	Time	Setpoint Temperature (Heat)	Setpoint Temperature (Cool)
Weekday	Wake 	6 a.m.	70° F (21° C)	75° F (24° C)
	Leave 	8 a.m.	62° F (17° C)	83° F (28° C)
	Return 	6 p.m.	70° F (21° C)	75° F (24° C)
	Sleep 	10 p.m.	62° F (17° C)	78° F (26° C)
Saturday	Wake 	8 a.m.	70° F (21° C)	75° F (24° C)
	Leave 	10 a.m.	62° F (17° C)	83° F (28° C)
	Return 	6 p.m.	70° F (21° C)	75° F (24° C)
	Sleep 	11 p.m.	62° F (17° C)	78° F (26° C)
Sunday	Wake 	8 a.m.	70° F (21° C)	75° F (24° C)
	Leave 	10 a.m.	62° F (17° C)	83° F (28° C)
	Return 	6 p.m.	70° F (21° C)	75° F (24° C)
	Sleep 	11 p.m.	62° F (17° C)	78° F (26° C)

Factory Default Program for 2 Time Periods				
Day of the Week	Events	Time	Setpoint Temperature (Heat)	Setpoint Temperature (Cool)
Weekday	Occupied	8 a.m.	70° F (21° C)	73° F (23° C)
	Unoccupied	6 p.m.	64° F (18° C)	80° F (27° C)
Saturday	Occupied	8 a.m.	70° F (21° C)	73° F (23° C)
	Unoccupied	6 p.m.	64° F (18° C)	80° F (27° C)
Sunday	Occupied	8 a.m.	70° F (21° C)	73° F (23° C)
	Unoccupied	6 p.m.	64° F (18° C)	80° F (27° C)

You can use the table below to plan your customized program schedule if using 5+1+1.

Programming Table				
Day of the Week	Events	Time	Setpoint Temperature (Heat)	Setpoint Temperature (Cool)
Weekday	Wake 			
	Leave 			
	Return 			
	Sleep 			
	Occupied			
	Unoccupied			
Saturday	Wake 			
	Leave 			
	Return 			
	Sleep 			
	Occupied			
	Unoccupied			
Sunday	Wake 			
	Leave 			
	Return 			
	Sleep 			
	Occupied			
	Unoccupied			

### Set Program Schedule For Four Time Periods (WAKE, LEAVE, RETURN, SLEEP)

To customize your 5+1+1 program schedule, follow these steps

#### Weekday:

1. Select **HEAT** or **COOL** using the **SYSTEM** (4) key.  
**Note:** You have to program heat and cool each separately.
2. Press **MENU** (7).
3. Press **SET SCHED** (8). **Note:** Monday-Friday is displayed and the **WAKE** icon is shown. You are now programming the **WAKE** time period for the weekday setting.
4. Time is flashing. Use the  or  key to make your time selection for the weekday **WAKE** time period. **Note:** If you want the fan to run continuously during this time period, select **ON** with the **FAN** (3) key.
5. Press **NEXT STEP** (10).
6. The setpoint temperature is flashing. Use the  or  key to make your setpoint selection for the weekday **WAKE** period.
7. Press **NEXT STEP** (10).
8. Repeat steps 4 through 7 for weekday **LEAVE** time period, for weekday **RETURN** time period, and for weekday **SLEEP** time period.

#### Saturday:

9. Repeat steps 4 through 7 for Saturday **WAKE** time period, for Saturday **LEAVE** time period, for Saturday **RETURN** time period, and for Saturday **SLEEP** time period.

#### Sunday:

10. Repeat steps 4 through 7 for Sunday **WAKE** time period, for Sunday **LEAVE** time period, for Sunday **RETURN** time period, and for Sunday **SLEEP** time period.

To customize your 7 day program schedule, follow these steps:

#### Monday

1. Select **HEAT** or **COOL** using the **SYSTEM** (4) key. You have to program heat and cool each separately.
2. Press **MENU** (7).
3. Press **SET SCHED** (8).  
**Note:** Monday is displayed and the **WAKE** icon is shown. You are now programming the **WAKE** time period for the Monday setting.
4. Time is flashing. Use the  or  key to make your time selection for the Monday **WAKE** time period. **Note:** If you want the fan to run continuously during this time period, select **ON** with the **FAN** (3) key.
5. Press **NEXT STEP** (10).
6. The setpoint temperature is flashing. Use the  or  key to make your setpoint selection for the Monday **WAKE** period.
7. Press **NEXT STEP** (10).
8. Repeat steps 4 thru 7 for Monday **LEAVE** time period, for Monday **RETURN** time period, and for Monday **SLEEP** time period.

#### Tuesday, Wednesday, Thursday, Friday, Saturday, Sunday

Repeat steps 4 thru 7 for the remaining days of the week.

#### A Note About Auto Changeover:

If in Auto you have the ability to switch between Auto Heat or Auto Cool by pressing the System key. This can be done once the current mode has reached its set-point. For example: if in Auto Heat, the heat setpoint must be satisfied before the thermostat will allow you to switch to Auto Cool. You can switch out of Auto by holding down the System key. To get back into Auto, you must toggle the System key to Auto.

#### A Note About Programmable Fan:

The programmable fan feature will run the fan continuously during any time period it is programmed to be on. This is the best way to keep the air circulated and to eliminate hot & cold spots in your building.

## Set Program Schedule For Two Time Periods (OCCUPIED, UNOCCUPIED)

To customize your 5+1+1 program schedule, follow these steps

### Weekday:

1. Select **HEAT** or **COOL** using the **SYSTEM** (4) key.  
**Note:** You have to program heat and cool each separately.
2. Press **MENU** (7).
3. Press **SET SCHED** (8). **Note:** Monday-Friday is displayed and the **OCCUPIED TEXT** is shown. You are now programming the **OCCUPIED** time period for the weekday setting.
4. Time is flashing. Use the  or  key to make your time selection for the weekday **OCCUPIED** time period. **Note:** If you want the fan to run continuously during this time period, select **ON** with the **FAN** (3) key.
5. Press **NEXT STEP** (10).
6. The setpoint temperature is flashing. Use the  or  key to make your setpoint selection for the weekday **OCCUPIED** period.
7. Press **NEXT STEP** (10).
8. Repeat steps 4 through 7 for weekday **UNOCCUPIED** time period.

### Saturday:

9. Repeat steps 4 through 7 for Saturday **OCCUPIED** time period and for Saturday **UNOCCUPIED** time period.

### Sunday:

10. Repeat steps 4 through 7 for Sunday **OCCUPIED** time period and for Sunday **UNOCCUPIED** time period.

### Monday

1. Select **HEAT** or **COOL** using the **SYSTEM** (4) key. You have to program heat and cool each separately.
2. Press **MENU** (7).
3. Press **SET SCHED** (8).  
**Note:** Monday is displayed and the **OCCUPIED** text is shown. You are now programming the **UNOCCUPIED** time period for the Monday setting.
4. Time is flashing. Use the  or  key to make your time selection for the Monday time period. **Note:** If you want the fan to run continuously during this time period, select the **FAN** (3) key.
5. Press **NEXT STEP** (10).
6. The setpoint temperature is flashing. Use the  or  key to make your setpoint selection for the Monday **OCCUPIED** period.
7. Press **NEXT STEP** (10).
8. Repeat steps 4 thru 7 for Monday **UNOCCUPIED** time period.

### Tuesday, Wednesday, Thursday, Friday, Saturday, Sunday

Repeat steps 4 thru 8 for the remaining days of the week.

# INSTALLATION MANUAL

## SPECIFICATIONS & CONTACT INFORMATION

### Specifications

---

The display range of temperature .....	41°F to 95°F (5°C to 35°C)
The control range of temperature .....	44°F to 90°F (7°C to 32°C)
Load rating .....	1 amp per terminal, 1.5 amp maximum all terminals combined
Display accuracy .....	± 1°F
Swing (cycle rate or differential) .....	Heating is adjustable from 0.2°F to 2.0°F Cooling is adjustable from 0.2°F to 2.0°F
Power source .....	18 to 30 VAC, NEC Class II, 50/60 Hz for hardwire (common wire) Battery power from 2 AA Alkaline Energizer batteries
Operating ambient .....	32°F to +105°F (0° to +41°C)
Operating humidity .....	90% non-condensing maximum
Dimensions of thermostat .....	4.7"W x 4.4"H x 1.1"D

### Contact Us

---

#### **Pro1 IAQ Inc.**

1111 S. Glenstone  
Suite 2-100  
Springfield, MO 65804

**Toll-free:** 1-888-Pro1iaq (776-1427)

**Toll Number (Outside the USA):** 330-821-3600

**Web:** <http://www.pro1iaq.com>

**Hours of Operation:** Monday - Friday 9 AM - 6 PM Eastern