



Panasonic Home and Environment Company
Division of Panasonic Corporation of North America
Executive Offices: One Panasonic Way
Secaucus, NJ 07094
(201) 348-7000
www.panasonic.com/building

Design and specifications subject to change without notice.

For Distributor Order Information
PHONE: 866-292-7299
FAX: 888-553-0723
ventfans@us.panasonic.com



2012 Ventilation Fans

Panasonic ideas for life



VF11290CAT

Panasonic ideas for life





High-performance ventilation solutions

Panasonic is the premier manufacturer of powerful, energy-efficient ventilation fans that quietly exhaust unhealthy, unpleasant or moist air from your home or business. Contractors, builders, architects and homeowners rely on us for our quality and for the wide array of solutions we offer—from bathroom fans with both motion and humidity sensors to remote in-line fans. Our entire line is ENERGY STAR® qualified, where guidelines exist, and we're proud to have been named an ENERGY STAR Partner of the Year for 2010 and 2011 in recognition of our longstanding commitment to energy efficiency and conserving our planet's resources.

The idea of delivering a breath of fresh air to our customers is consistent with a simple mission statement eloquently articulated by our founder nearly a century ago: Panasonic serves society with high-quality products that make peoples' everyday lives more healthy, productive and enjoyable. This guiding principle continues to drive everything we do and is what we call "ideas for life."

Fresh air driven by fresh ideas. Breathe new life into your environment with Panasonic Ventilation.

Panasonic ideas for life

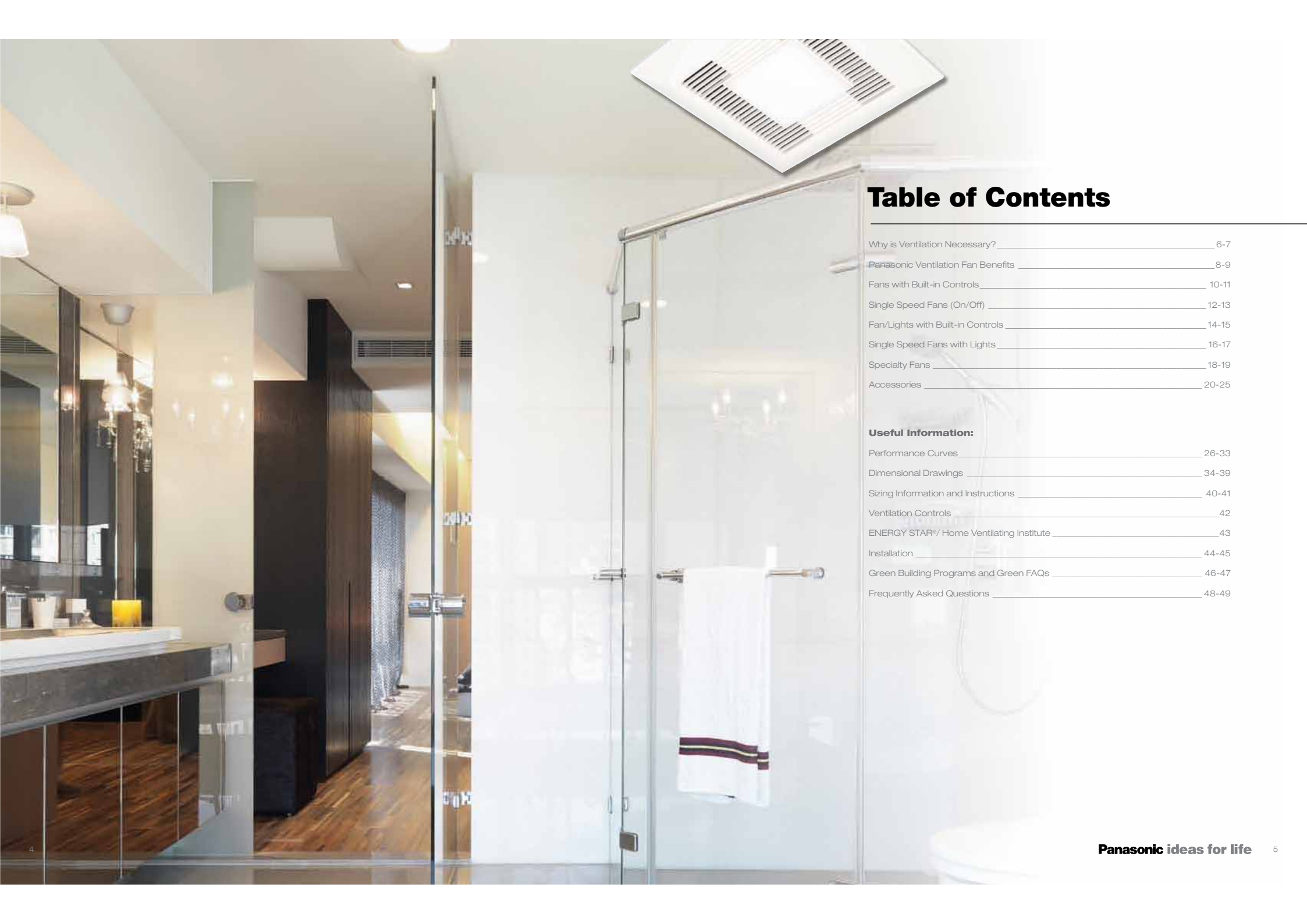

Table of Contents

| | |
|--|-------|
| Why is Ventilation Necessary? _____ | 6-7 |
| Panasonic Ventilation Fan Benefits _____ | 8-9 |
| Fans with Built-in Controls _____ | 10-11 |
| Single Speed Fans (On/Off) _____ | 12-13 |
| Fan/Lights with Built-in Controls _____ | 14-15 |
| Single Speed Fans with Lights _____ | 16-17 |
| Specialty Fans _____ | 18-19 |
| Accessories _____ | 20-25 |
| Useful Information: | |
| Performance Curves _____ | 26-33 |
| Dimensional Drawings _____ | 34-39 |
| Sizing Information and Instructions _____ | 40-41 |
| Ventilation Controls _____ | 42 |
| ENERGY STAR®/ Home Ventilating Institute _____ | 43 |
| Installation _____ | 44-45 |
| Green Building Programs and Green FAQs _____ | 46-47 |
| Frequently Asked Questions _____ | 48-49 |



Why is ventilation necessary?

Today's homes are designed and built to improve energy efficiency. However, these airtight homes may actually cause health problems due to the build-up of pollutants and uncirculated stale air. What do they need? Mechanical ventilation!

Airtight Homes

Homes designed and built in recent years are more airtight and energy efficient than in the past. To obtain this airtight design, house wraps, newly designed windows and doors, sealing caulks and other insulating materials are used to create better energy efficiency. The resulting benefit is fewer drafts, which lowers the cost to heat and air-condition a home. But pollutants retained in airtight buildings can be hazardous to their occupants and can jeopardize structural integrity. That's why Panasonic stresses a "build tight and ventilate right" platform. Proper mechanical ventilation design can address poor indoor air quality, while retaining energy efficiency.

Biological Pollutants

Biological pollutants, to some degree, are found in all homes. These include mold, mildew, pollen, dust mites, pet dander, viruses and bacteria. Accumulation of these biological pollutants can result in hazardous health effects for the occupants, as well as structural damage to the building.

Volatile Organic Compounds (VOCs)

Volatile Organic Compounds are carbon-based compounds that easily evaporate. Formaldehyde and these types of gases are released from building materials, carpets, furniture and many other solid household items as part of aging, decomposition or curing, all of which are natural processes known as off-gassing. Some other household items that emit VOCs include hair sprays, paints, lacquers, finishes, oven cleaners and other cleaning solvents, pesticides, etc. Often colorless and odorless, VOCs can ultimately sensitize certain people to react to them.

Ways to improve indoor air quality

The first step to improve indoor air quality should be to reduce or remove the source of the pollutants.

Unfortunately, indoor pollutants are virtually impossible to eliminate completely, creating the need for a second step to improve indoor air quality—mechanical ventilation. Mechanical ventilation is used to remove stale, moist, polluted air and replace it with fresh outside air. Two widely used methods in today's building industry are continuous and intermittent ventilation.

Continuous Ventilation

Sometimes referred to as general, central, whole-house or primary ventilation, continuous ventilation is used to remove

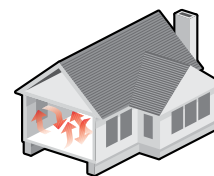

Bad

Pollutants such as smoke, formaldehyde, dust, humidity and VOCs accumulate in a poorly vented building.

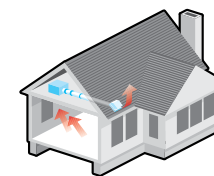

Good

Ventilation fans help to maintain indoor air flow and air quality.

Ideally, an airtight home designed with both continuous and intermittent ventilation will contribute to a healthy and comfortable living environment for the entire family.

stale air and provide fresh air on a slow, continuous basis. A well-designed airtight home can generally use low volume continuous ventilation.

Intermittent Ventilation

Sometimes referred to as spot, local or secondary ventilation, intermittent ventilation is used to capture and remove pollutants quickly at the source. Pockets of excessive moisture and pollutants can build up in the bathroom, kitchen, utility room, garage and home office. This secondary process serves to exhaust these problem areas quickly, before bad air can spread throughout the house. Just as important as continuous ventilation, intermittent ventilation complements the effort to improve indoor air quality.

Both systems exhaust pollutants from the air, but intermittent ventilation is more effective in concentrated areas.

Sizing Information and Instructions

Properly sized ventilation in airtight homes helps to ensure healthy indoor air quality. Both intermittent (spot) and continuous (whole house) ventilation should be considered. Intermittent ventilation is used to exhaust sources of moisture and odors, while continuous ventilation is used to remove accumulated indoor air pollutants.

Airtight Homes

The first step when sizing for a ventilating fan is to determine the application. Decide whether you are sizing for intermittent or continuous ventilation (see pages 6 and 7). If intermittent, determine which application, (i.e. bathroom, kitchen or other). Use the following industry recommendations to determine Air Changes per Hour (ACH) for your specific application.

Intermittent (spot) ventilation:

The Home Ventilating Institute (HVI) recommends the following Air Changes per Hour (ACH). (See HVI on page 43)

- I. Bathrooms - 8 ACH or 1 CFM/sq ft
- II. Kitchens - 15 ACH or 2 CFM/sq ft
- III. Other Rooms - 6 ACH or .75 CFM/sq ft

Continuous (whole house) ventilation:

Most building codes have adopted the American Society of Heating, Refrigerating, and Air Conditioning Engineers (ASHRAE) Standard 62. The most current version, ASHRAE 62.2-2010, calls for continuous mechanical ventilation as shown below.

- I. House or apartment - 7.5 CFM per person plus 1 CFM per 100 square feet

The second step is to calculate the area being ventilated. Calculate square feet or cubic feet depending on which sizing method you choose.

The third step is to calculate the Equivalent Duct Length of the planned duct run. This requires a basic understanding of static pressure caused by a duct run design and its components.

Static Pressure and Duct Run: A ventilating fan must overcome resistance when pulling air through the grille and pushing it through the duct and cap to the outside of the building. This resistance is known as static pressure. The amount of static pressure depends on the duct length, type of duct, elbows and the roof jack or wall cap.



Panasonic Ventilation Fan Benefits

Certified & Code Compliant

Panasonic ventilation fans are certified by the Home Ventilating Institute (HVI) and ENERGY STAR® qualified, where guidelines exist. All models also comply with ASHRAE 62.2, the ventilation standard required by LEED for Homes, ENERGY STAR IAP, CalGreen, NAHB Green Building Standard, EarthCraft, Washington Ventilation Code and other building programs.

Powerful & Quiet

Fully enclosed DC and AC condenser motors assure remarkable performance and quiet operation at industry standard, .25" w.g.

Long Life

Permanently lubricated motors are engineered for trouble-free, continuous operation for 30,000 hours on AC motors, along with rust-proof paint and galvanized housing.

Easy Installation

Detachable duct adapters, adjustable mounting brackets (up to 24" o.c.), fan/motor units that easily detach from the housing and uncomplicated wiring all lend to user-friendly installation. Double-hanger bar systems allowing for ideal positioning.

Energy Savings

For high energy efficiency, input wattage readings are among the lowest in the industry.

Safety

WhisperGreen models are protected by UL Class 2 Power Unit while all other models are equipped with thermal fuse protection. With the exception of the ERV and heater fans, all models are UL listed for tub/shower enclosure when used with a GFCI branch circuit wire.

Airflow

A built-in damper in all ceiling-mounted models prevents backdraft.

Illumination

ENERGY STAR rated/CA Title 24 compliant compact fluorescent light bulbs with 10,000 hours of rated life and a 4-Watt night light are available on select models.

Green Manufacturing

All fan only models are RoHS Approved. Restriction of Hazardous Substances Directive (RoHS) restricts the use of the following six substances in the manufacturing process: Lead, Mercury, Cadmium, Hexavalent chromium [CR(VI)], Polybrominated biphenyls (PBB), and Polybrominated diphenyl ether (PBDE).

Warranty

6 Year warranty on DC motor and 3 Year warranty on all other models and parts.



Panasonic ideas for life

Fans with Built-in Controls

WhisperGreen™
VENTILATION FAN



7-2/5" Depth

FV-08VKM3 80 CFM 4" or 6" Duct
FV-08VKS3 80 CFM 4" or 6" Duct

FV-13VKM3 130 CFM 6" Duct
FV-13VKS3 130 CFM 6" Duct

WhisperGreen Key Benefits:

- SmartFlow™ technology for optimal CFM output
- Fully enclosed DC motor for long life – rated for 60,000 hours continuous run
- SmartAction® motion sensor - (FV-08VKM3, FV-13VKM3)

- Built-in variable speed controls and high/low delay timer up to 60 minutes
- Detachable dual 4" or 6" duct adaptor on 80 CFM models included
- Fits in 2 x 8 construction

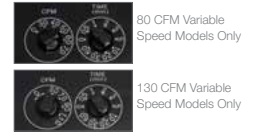

80 CFM Variable Speed Models Only

130 CFM Variable Speed Models Only

| WhisperGreen Characteristics | FV-08VKS3 FV-08VKM3 | | | | | | | | | | | | FV-13VKS3 FV-13VKM3 | | | | | | | | | |
|-------------------------------|---------------------------------|------|------|------|------|------|------|------|------|------|------|------|-----------------------|------|------|------|------|------|------|------|------|------|
| | Static pressure in inches w. g. | 0.1 | 0.25 | 0.1 | 0.25 | 0.1 | 0.25 | 0.1 | 0.25 | 0.1 | 0.25 | 0.1 | 0.25 | 0.1 | 0.25 | 0.1 | 0.25 | 0.1 | 0.25 | 0.1 | 0.25 | 0.1 |
| Air Volume (CFM) | 80 | 79 | 70 | 75 | 60 | 59 | 50 | 53 | 40 | 39 | 30 | 32 | 130 | 135 | 110 | 110 | 90 | 93 | 70 | 70 | 50 | 52 |
| Noise (sones) | <0.3 | 0.4 | <0.3 | 0.4 | <0.3 | 0.3 | <0.3 | 0.3 | <0.3 | <0.3 | <0.3 | <0.3 | <0.3 | 0.7 | <0.3 | 0.6 | <0.3 | 0.6 | <0.3 | 0.4 | <0.3 | <0.3 |
| Power Consumption (Watts) | 7.0 | 11.0 | 5.4 | 10.1 | 5.0 | 8.7 | 4.3 | 7.5 | 3.7 | 6.6 | 3.2 | 5.8 | 11.9 | 21.5 | 9.0 | 15.6 | 6.2 | 12.5 | 4.1 | 9.8 | 2.4 | 5.9 |
| Energy Efficiency (CFMs/Watt) | 12.1 | 7.6 | 13.3 | 7.7 | 13.6 | 7.7 | 12.4 | 7.7 | 12.8 | 7.1 | 11.4 | 6.7 | 11.2 | 6.4 | 12.5 | 7.3 | 15.2 | 7.8 | 18.7 | 7.9 | 23.3 | 10.0 |
| Speed | 832 | 1130 | 791 | 1125 | 773 | 1106 | 749 | 1101 | 740 | 1093 | 745 | 1087 | 662 | 917 | 643 | 912 | 580 | 900 | 506 | 874 | 430 | 781 |
| Current | 0.02 | 0.01 | 0.03 | 0.01 | 0.05 | 0.01 | 0.05 | 0.02 | 0.05 | 0.03 | 0.06 | 0.04 | 0.01 | 0.12 | 0.03 | 0.09 | 0.02 | 0.07 | 0.04 | 0.01 | 0.06 | 0.03 |
| Power Rating (V/Hz) | 120/60 | | | | | | | | | | | | 120/60 | | | | | | | | | |



WhisperSense™
VENTILATION FAN



7-2/5" Depth

FV-08VQC5 80 CFM 4" or 6" Duct
FV-11VQC5 110 CFM 4" or 6" Duct

WhisperSense Key Benefits:

- Dual motion and humidity sensors with versatile functionality.
 - Motion On / Motion Off
 - Motion On / Humidity Off
 - Humidity On / Humidity Off
- Adjustable delay timer from 30 seconds to 60 minutes
- Variable humidity controls from 30-80% RH (Relative Humidity)
- Built-in sensors, timers and controls
- Detachable dual 4" or 6" duct adaptor included
- Fits in 2 x 8 construction

| WhisperSense Characteristics | FV-08VQC5 | | FV-11VQC5 | |
|---------------------------------|-----------|------|-----------|------|
| Static pressure in inches w. g. | 0.1 | 0.25 | 0.1 | 0.25 |
| Air Volume (CFM) | 80 | 59 | 110 | 91 |
| Noise (sones) | <0.3 | <0.3 | 0.3 | 0.5 |
| Power Consumption (Watts) | 15.8 | 15.6 | 24.3 | 24.2 |
| Energy Efficiency (CFMs/Watt) | 5.1 | 3.9 | 4.6 | 3.9 |
| Speed | 825 | 1110 | 957 | 1170 |
| Current | 0.14 | 0.14 | 0.22 | 0.21 |
| Power Rating (V/Hz) | 120/60 | | | |



WhisperWelcome™
VENTILATION FAN



5-5/8" Depth

INCLUDED:
4 to 3 inch adaptor

FV-05VFM2 50 CFM 4" or 3" Duct
FV-08VFM2 80 CFM 4" or 3" Duct

WhisperWelcome Key Benefits:

- Low profile housing design – Ideal for remodeling!
- SmartAction® motion sensor with built-in 20-minute delay timer
- Fits in 2 x 6 & 2 x 8 construction

| WhisperWelcome Characteristics | FV-05VFM2 | | | | FV-08VFM2 | | | |
|---------------------------------|-----------|------|------|------|-----------|------|------|------|
| Static pressure in inches w. g. | 0.1 | 0.25 | 0.1 | 0.25 | 0.1 | 0.25 | 0.1 | 0.25 |
| Air Volume (CFM) | 50 | 33 | 50 | 34 | 80 | 62 | 80 | 63 |
| Noise (sones) | 0.4 | 0.7 | 0.5 | 0.8 | 0.9 | 1.0 | 0.9 | 1.1 |
| Power Consumption (Watts) | 16.3 | 16.0 | 16.1 | 16.0 | 24.2 | 23.8 | 23.9 | 23.4 |
| Energy Efficiency (CFMs/Watt) | 3.6 | 2.4 | 3.3 | 2.2 | 3.5 | 2.7 | 3.1 | 2.5 |
| Speed | 678 | 924 | 740 | 958 | 749 | 945 | 868 | 1003 |
| Current | 0.13 | 0.13 | 0.13 | 0.13 | 0.20 | 0.19 | 0.20 | 0.19 |
| Power Rating (V/Hz) | 120/60 | | | | 120/60 | | | |



Single Speed Fans (On/Off)

WhisperGreen™
VENTILATION FAN



7-2/5" Depth

FV-05VK3 50 CFM 4" or 6" Duct
FV-08VK3 80 CFM 4" or 6" Duct
FV-11VK3 110 CFM 4" or 6" Duct

WhisperGreen Key Benefits:

- SmartFlow™ technology for optimal CFM output
- Fully enclosed DC motor for long life – rated for 60,000 hours continuous run
- Detachable dual 4" or 6" duct adaptor included
- Fits in 2 x 8 construction

| WhisperGreen Characteristics | FV-05VK3 | FV-08VK3 | FV-11VK3 | | | |
|---------------------------------|----------|----------|----------|------|------|------|
| Static pressure in inches w. g. | 0.1 | 0.25 | 0.1 | 0.25 | 0.1 | 0.25 |
| Air Volume (CFM) | 50 | 54 | 80 | 79 | 110 | 112 |
| Noise (sones) | <0.3 | 0.3 | <0.3 | 0.4 | 0.3 | 0.8 |
| Power Consumption (Watts) | 4.3 | 7.5 | 7.0 | 11.0 | 11.5 | 16.2 |
| Energy Efficiency (CFMs/Watt) | 12.4 | 7.7 | 12.1 | 7.6 | 9.7 | 7.0 |
| Speed | 749 | 1101 | 832 | 1130 | 953 | 1229 |
| Current | 0.05 | 0.02 | 0.02 | 0.01 | 0.21 | 0.30 |
| Power Rating (V/Hz) | 120/60 | | | | | |



CALGreen



WhisperCeiling™
VENTILATION FAN



7-2/5" Depth



FV-05VQ5 50 CFM 4" or 6" Duct
FV-08VQ5 80 CFM 4" or 6" Duct
FV-11VQ5 110 CFM 4" or 6" Duct

FV-15VQ5 150 CFM 6" Duct

WhisperCeiling Key Benefits:

- Detachable dual 4" or 6" duct adaptor on 50-110 CFM models
- Fits in 2 x 8 construction

| WhisperCeiling Characteristics | FV-05VQ5 | FV-08VQ5 | FV-11VQ5 | FV-15VQ5 | | | | |
|---------------------------------|----------|----------|----------|----------|------|------|------|------|
| Static pressure in inches w. g. | 0.1 | 0.25 | 0.1 | 0.25 | 0.1 | 0.25 | | |
| Air Volume (CFM) | 50 | 36 | 80 | 62 | 110 | 91 | 150 | 127 |
| Noise (sones) | <0.3 | 0.5 | <0.3 | 0.4 | <0.3 | 0.5 | <0.3 | 0.5 |
| Power Consumption (Watts) | 11.0 | 11.5 | 14.7 | 14.5 | 21.1 | 20.7 | 28.4 | 27.3 |
| Energy Efficiency (CFMs/Watt) | 4.7 | 3.2 | 5.8 | 4.5 | 5.3 | 4.5 | 5.3 | 4.7 |
| Speed | 731 | 1060 | 829 | 1089 | 950 | 1161 | 691 | 911 |
| Current | 0.09 | 0.10 | 0.12 | 0.12 | 0.18 | 0.17 | 0.24 | 0.23 |
| Power Rating (V/Hz) | 120/60 | | | | | | | |



CALGreen



WhisperFit™
VENTILATION FAN



5-5/8" Depth



INCLUDED:
4 to 3 inch adaptor

FV-05VF2 50 CFM 4" or 3" Duct
FV-08VF2 80 CFM 4" or 3" Duct
FV-11VF2 110 CFM 4" or 3" Duct

WhisperFit Key Benefits:

- Low profile housing design – Ideal for remodeling!
- Fits in 2 x 6 & 2 x 8 construction

| WhisperFit Characteristics | FV-05VF2 | | FV-08VF2 | | FV-11VF2 | | | | | | | |
|---------------------------------|----------|---------|----------|---------|----------|---------|------|------|------|------|------|------|
| | 4" Duct | 3" Duct | 4" Duct | 3" Duct | 4" Duct | 3" Duct | | | | | | |
| Static pressure in inches w. g. | 0.1 | 0.25 | 0.1 | 0.25 | 0.1 | 0.25 | | | | | | |
| Air Volume (CFM) | 50 | 30 | 50 | 31 | 80 | 60 | 70 | 53 | 110 | 94 | 90 | 78 |
| Noise (sones) | 0.4 | 0.9 | 0.5 | 1.1 | 0.8 | 1.0 | 0.8 | 1.1 | 1.5 | 1.5 | 1.5 | 2.0 |
| Power Consumption (Watts) | 15.0 | 14.7 | 15.0 | 14.8 | 24.5 | 24.3 | 24.3 | 24.0 | 33.5 | 33.2 | 33.8 | 33.5 |
| Energy Efficiency (CFMs/Watt) | 3.3 | 2.0 | 3.3 | 2.1 | 3.3 | 2.5 | 2.9 | 2.2 | 3.3 | 2.8 | 2.7 | 2.3 |
| Speed | 637 | 932 | 741 | 978 | 757 | 956 | 845 | 1007 | 830 | 1000 | 1029 | 1128 |
| Current | 0.13 | 0.12 | 0.13 | 0.12 | 0.20 | 0.20 | 0.20 | 0.20 | 0.28 | 0.28 | 0.28 | 0.28 |
| Power Rating (V/Hz) | 120/60 | | 120/60 | | 120/60 | | | | | | | |



CALGreen



WhisperValue™
VENTILATION FAN



3-3/4" Depth

WhisperValue U-Can Contractor Pack

The Contractor Pack includes four complete fans. The housing and motor/grille are packaged separately for flexibility during installation.

| Universal Housing Can | Motor/Grille Assembly | Complete Fan Unit | Master Pack |
|-----------------------|-----------------------|-------------------|-------------|
| FV-05-08VSA1 | FV-05VSB1 | FV-05VS1 | 4 |
| FV-05-08VSA1 | FV-08VSB1 | FV-08VS1 | 4 |
| FV-05-08VSA1 | FV-10VSB1 | FV-10VS1 | 4 |

FV-05VS1 50 CFM 4" Oval Duct
FV-08VS1 80 CFM 4" Oval Duct
FV-10VS1 100 CFM 4" Oval Duct

WhisperValue Key Benefits:

- Super low profile housing design
- UL listed for wall or ceiling installation
- Fits in 2 x 4, 2 x 6 & 2 x 8 construction

| WhisperValue Characteristics | FV-05VS1 | FV-08VS1 | FV-10VS1 | | | |
|---------------------------------|----------|----------|----------|------|--------|------|
| Static pressure in inches w. g. | 0.1 | 0.25 | 0.1 | 0.25 | | |
| Air Volume (CFM) | 50 | 37 | 80 | 71 | 100 | 90 |
| Noise (sones) | 0.4 | 1.0 | 1.3 | 1.5 | 1.5 | 1.5 |
| Power Consumption (Watts) | 18.1 | 17.8 | 27.4 | 27.6 | 36.4 | 36.1 |
| Energy Efficiency (CFMs/Watt) | 3.2 | 2.4 | 3.4 | 2.8 | 2.9 | 2.7 |
| Speed (RPM) | 759 | 948 | 878 | 1026 | 840 | 979 |
| Current (amps) | 0.04 | 0.04 | 0.11 | 0.11 | 0.30 | 0.30 |
| Power Rating (V/Hz) | 120/60 | | 120/60 | | 120/60 | |



CALGreen



Fan/Lights with Built-in Controls

WhisperGreen-Lite™
VENTILATION FAN



7-2/5" Depth



INCLUDES: One 32-Watt Panasonic CFL/3500 Kelvin/High CRI/2400 Lumens/ENERGY STAR® qualified/10,000 hours rated average life/equivalent to (2) 75-Watt incandescent lamp/electronic ballast for flicker-free operation/plus 4-Watt night-light

FV-08VKML3 80 CFM 4" or 6" Duct
FV-08VKSL3 80 CFM 4" or 6" Duct
FV-13VKML3 130 CFM 6" Duct
FV-13VKSL3 130 CFM 6" Duct



80 CFM Variable Speed Models Only



130 CFM Variable Speed Models Only



CALGreen



WhisperGreen-Lite Key Benefits:

- SmartFlow™ technology for optimal CFM output
- Fully enclosed DC motor for lone life – rated for 60,000 hours continuous run
- SmartAction® motion sensor - (FV-08VKML3, FV-13VKML3)
- Built-in variable speed controls and high/low delay timer up to 60 minutes
- Detachable dual 4" or 6" duct adaptor for 80 CFM models included
- Fits in 2 x 8 construction

| WhisperGreen-Lite Characteristics | FV-08VKSL3 FV-08VKML3 | | | | | | | | | | FV-13VKSL3 FV-13VKML3 | | | | | | | | | | | |
|-----------------------------------|---------------------------------|------|------|------|------|------|------|------|------|------|-------------------------|------|------|------|------|------|------|------|------|------|------|------|
| | Static pressure in inches w. g. | 0.1 | 0.25 | 0.1 | 0.25 | 0.1 | 0.25 | 0.1 | 0.25 | 0.1 | 0.25 | 0.1 | 0.25 | 0.1 | 0.25 | 0.1 | 0.25 | 0.1 | 0.25 | 0.1 | 0.25 | 0.1 |
| Air Volume (CFM) | 80 | 79 | 70 | 77 | 60 | 60 | 50 | 52 | 40 | 41 | 30 | 35 | 130 | 136 | 110 | 114 | 90 | 90 | 70 | 68 | 50 | 56 |
| Noise (sones) | <0.3 | 0.6 | <0.3 | 0.6 | <0.3 | 0.5 | <0.3 | 0.5 | <0.3 | 0.5 | <0.3 | 0.5 | 0.8 | 1.3 | 0.6 | 1.2 | 0.3 | 1.1 | <0.3 | 0.9 | <0.3 | 0.8 |
| Power Consumption (Watts) | 7.4 | 12.4 | 6.0 | 11.6 | 5.3 | 9.0 | 4.2 | 7.8 | 3.8 | 6.7 | 3.5 | 6.2 | 14.4 | 24.7 | 11.0 | 20.0 | 8.0 | 15.3 | 6.1 | 10.8 | 4.2 | 8.7 |
| Energy Efficiency (CFMs/Watt) | 11.2 | 6.6 | 11.9 | 6.8 | 12.1 | 7.2 | 12.5 | 7.0 | 11.1 | 6.6 | 8.8 | 5.8 | 9.0 | 5.5 | 10.1 | 5.8 | 11.5 | 6.1 | 12.0 | 6.7 | 12.3 | 6.7 |
| Speed | 866 | 1166 | 815 | 1157 | 675 | 941 | 765 | 1106 | 758 | 1084 | 611 | 879 | 742 | 968 | 707 | 972 | 676 | 969 | 669 | 932 | 648 | 939 |
| Current | 0.01 | 0.02 | 0.03 | 0.02 | 0.05 | 0.09 | 0.04 | 0.02 | 0.06 | 0.05 | 0.04 | 0.06 | 0.04 | 0.15 | 0.05 | 0.12 | 0.03 | 0.09 | 0.03 | 0.01 | 0.04 | 0.01 |
| Power Rating (V/Hz) | 120/60 | | | | | | | | | | 120/60 | | | | | | | | | | | |

WhisperSense-Lite™
VENTILATION FAN



7-2/5" Depth



INCLUDES: One 32-Watt Panasonic CFL/3500 Kelvin/High CRI/2400 Lumens/ENERGY STAR® qualified/10,000 hours rated average life/equivalent to (2) 75-Watt incandescent lamp/electronic ballast for flicker-free operation/plus 4-Watt night-light

FV-08VQCL5 80 CFM 4" or 6" Duct
FV-11VQCL5 110 CFM 4" or 6" Duct

WhisperSense-Lite Key Benefits:

- Dual motion and humidity sensors with versatile functionality.
 - Motion On / Motion Off
 - Motion On / Humidity Off
 - Humidity On / Humidity Off
- Adjustable delay timer from 30 seconds to 60 minutes
- Variable humidity controls from 30-80% RH (Relative Humidity)
- Built-in sensors, timers and controls
- Detachable dual 4" or 6" duct adaptor included
- Fits in 2 x 8 construction

| WhisperSense Characteristics | FV-08VQCL5 | | FV-11VQCL5 | |
|-------------------------------|---------------------------------|------|------------|------|
| | Static pressure in inches w. g. | 0.1 | 0.25 | 0.1 |
| Air Volume (CFM) | 80 | 62 | 110 | 89 |
| Noise (sones) | <0.3 | 0.4 | 0.7 | 0.7 |
| Power Consumption (Watts) | 17.5 | 17.6 | 26.0 | 25.7 |
| Energy Efficiency (CFMs/Watt) | 4.7 | 3.6 | 4.3 | 3.5 |
| Speed | 825 | 1110 | 957 | 1170 |
| Current | 0.14 | 0.14 | 0.22 | 0.21 |
| Power Rating (V/Hz) | 120/60 | | | |



CALGreen



Single Speed Fans with Lights (On/Off)

WhisperGreen-Lite™



INCLUDES: One 32-Watt Panasonic CFL/3500 Kelvin/ High CRI/2400 Lumens/ENERGY STAR® qualified/10,000 hours rated average life/equivalent to (2) 75-Watt incandescent lamp/electronic ballast for flicker-free operation/plus 4-Watt night-light

FV-08VKL3 80 CFM 4" or 6" Duct
FV-11VKL3 110 CFM 4" or 6" Duct

WhisperGreen-Lite Key Benefits:

- SmartFlow™ technology for optimal CFM output
- Fully enclosed DC motor for long life – rated for 60,000 hours continuous run
- Detachable dual 4" or 6" duct adaptor included
- Fits in 2 x 8 construction

| WhisperGreen-Lite | FV-08VKL3 | | FV-11VKL3 | |
|---------------------------------|-----------|------|-----------|------|
| Characteristics | | | | |
| Static pressure in inches w. g. | 0.1 | 0.25 | 0.1 | 0.25 |
| Air Volume (CFM) | 80 | 79 | 110 | 108 |
| Noise (sones) | <0.3 | 0.6 | 0.7 | 1.1 |
| Power Consumption (Watts) | 7.4 | 12.4 | 12.5 | 18 |
| Energy Efficiency (CFMs/Watt) | 11.2 | 6.6 | 8.9 | 6.0 |
| Speed | 866 | 1166 | 1019 | 1256 |
| Current | 0.01 | 0.02 | 0.25 | 0.34 |
| Power Rating (V/Hz) | 120/60 | | | |

WhisperLite™



INCLUDES: One 32-Watt Panasonic CFL/3500 Kelvin/ High CRI/2400 Lumens/ENERGY STAR® qualified/10,000 hours rated average life/equivalent to (2) 75-Watt incandescent lamp/electronic ballast for flicker-free operation/plus 4-Watt night-light

FV-08VQL5 80 CFM 4" or 6" Duct
FV-11VQL5 110 CFM 4" or 6" Duct
FV-15VQL5 150 CFM 6" Duct

WhisperLite Key Benefits:

- Detachable dual 4" or 6" duct adaptor on 80-110 CFM models included
- Fits in 2 x 8 construction

| WhisperLite | FV-08VQL5 | | FV-11VQL5 | | FV-15VQL5 | |
|---------------------------------|-----------|------|-----------|------|-----------|------|
| Characteristics | | | | | | |
| Static pressure in inches w. g. | 0.1 | 0.25 | 0.1 | 0.25 | 0.1 | 0.25 |
| Air Volume (CFM) | 80 | 62 | 110 | 90 | 150 | 128 |
| Noise (sones) | <0.3 | 0.4 | 0.5 | 0.6 | 0.9 | 1.0 |
| Power Consumption (Watts) | 14.9 | 14.7 | 23.4 | 23.0 | 31.8 | 30.9 |
| Energy Efficiency (CFMs/Watt) | 5.5 | 4.3 | 4.7 | 3.9 | 4.8 | 4.2 |
| Speed | 863 | 1117 | 1006 | 1193 | 800 | 988 |
| Current | 0.12 | 0.12 | 0.20 | 0.19 | 0.27 | 0.26 |
| Power Rating (V/Hz) | 120/60 | | | | | |



CAI Green



WhisperFit-Lite™



INCLUDES:
4 to 3 inch adaptor



INCLUDES: Two 18-Watt Panasonic CFL/3500 Kelvin/High CRI/1200 Lumens each/ENERGY STAR® qualified/10,000 hours rated average life/equivalent to 100-Watt incandescent lamp/electronic ballast for flicker-free operation/plus 4-Watt night-light

FV-05VFL2 50 CFM 4" or 3" Duct
FV-08VFL2 80 CFM 4" or 3" Duct
FV-11VFL2 110 CFM 4" or 3" Duct

WhisperFit-Lite Key Benefits:

- Low profile housing design – Ideal for remodeling!
- Fits in 2 x 6 & 2 x 8 construction

| WhisperFit-Lite | FV-05VFL2 | | FV-08VFL2 | | FV-11VFL2 | |
|---------------------------------|-----------|---------|-----------|---------|-----------|---------|
| Characteristics | 4" Duct | 3" Duct | 4" Duct | 3" Duct | 4" Duct | 3" Duct |
| Static pressure in inches w. g. | 0.1 | 0.25 | 0.1 | 0.25 | 0.1 | 0.25 |
| Air Volume (CFM) | 50 | 35 | 80 | 63 | 70 | 57 |
| Noise (sones) | <0.3 | 0.4 | <0.3 | 0.5 | 0.8 | 0.8 |
| Power Consumption (Watts) | 16.6 | 16.5 | 16.6 | 16.5 | 29.7 | 29.1 |
| Energy Efficiency (CFMs/Watt) | 3.0 | 2.1 | 3.0 | 2.1 | 2.7 | 2.2 |
| Speed | 703 | 917 | 769 | 989 | 828 | 981 |
| Current | 0.14 | 0.14 | 0.14 | 0.14 | 0.25 | 0.24 |
| Power Rating (V/Hz) | 120/60 | | 120/60 | | 120/60 | |



CAI Green



WhisperValue-Lite™



WhisperValue-Lite U-Can Contractor Pack

The Contractor Pack includes four complete fans. The housing and motor/grille are packaged separately for flexibility during installation.

| Universal Housing Can | Motor/Grille Assembly | Complete Fan Unit | Master Pack |
|-----------------------|-----------------------|-------------------|-------------|
| FV-08VSLA1 | FV-08VSLB1 | FV-08VSL1 | 4 |
| FV-08VSLA1 | FV-10VSLB1 | FV-10VSL1 | 4 |



INCLUDES: Two 18-Watt Panasonic CFL/3500 Kelvin/High CRI/1200 Lumens each/ENERGY STAR® qualified/10,000 hours rated average life/equivalent to 100-Watt incandescent lamp/electronic ballast for flicker-free operation/plus 4-Watt night-light

FV-08VSL1 80 CFM 4" Oval Duct
FV-10VSL1 100 CFM 4" Oval Duct

WhisperValue-Lite Key Benefits:

- Super low profile housing design
- First in 2 x 4, 2 x 6 and 2 x 8 construction

| WhisperValue-Lite | FV-08VSL1 | | FV-10VSL1 | |
|---------------------------------|--------------|------|--------------|------|
| Characteristics | 4" Oval Duct | | 4" Oval Duct | |
| Static pressure in inches w. g. | 0.1 | 0.25 | 0.1 | 0.25 |
| Air Volume (CFM) | 80 | 67 | 100 | 90 |
| Noise (sones) | 1.3 | 1.5 | 1.5 | 2.5 |
| Power Consumption (Watts) | 24.4 | 24.9 | 36.6 | 36.3 |
| Energy Efficiency (CFMs/Watt) | 3.3 | 2.7 | 2.9 | 2.6 |
| Speed (RPM) | 944 | 1063 | 911 | 1019 |
| Current (amps) | 0.11 | 0.11 | 0.30 | 0.30 |
| Power Rating (V/Hz) | 120/60 | | 120/60 | |

Performance Curves on pages 26-33.

Specialty Fans

WhisperWarm™ VENTILATION FAN



FV-11VH2 110 CFM 4" Duct
FV-11VHL2 110 CFM 4" Duct



FV-11VHL2 INCLUDES: Two 18-Watt Panasonic CFL/3500 Kelvin/High CRI/1200 Lumens each/ENERGY STAR® qualified/10,000 hours rated average life/equivalent to 100-Watt incandescent lamp/electronic ballast for flicker-free operation/plus 4-Watt night-light

WhisperWarm Key Benefits:

- Durable 1400 Watt stainless steel sheathed heating element
- Thermal fuse protection on motor and 3-level safety device for heater
- Quick 1 minute warm-up
- Fits in 2 x 8 construction

| WhisperWarm Characteristics | FV-11VH2 | FV-11VHL2 |
|---------------------------------|----------|-----------|
| Static pressure in inches w. g. | 0.1 | 0.25 |
| Air Volume (CFM) | 110 | 89 |
| Noise (sones) | 0.6 | 1.1 |
| Power Consumption (Watts) | 30.7 | 30.5 |
| Energy Efficiency (CFMs/Watt) | 3.6 | 2.9 |
| Speed | 778 | 935 |
| Current | 0.25 | 0.25 |
| Power Rating (V/Hz) | 120/60 | |



WhisperCeiling™ VENTILATION FAN



FV-20VQ3 190 CFM 6" Duct
FV-30VQ3 290 CFM 6" Duct
FV-40VQ3 380 CFM 6" Duct

WhisperCeiling Key Benefits:

- Large volume exhaust fans ideal for light commercial applications

| WhisperCeiling Characteristics | FV-20VQ3 | FV-30VQ3 | FV-40VQ3 |
|---------------------------------|----------|----------|----------|
| Static pressure in inches w. g. | 0.1 | 0.25 | 0.1 |
| Air Volume (CFM) | 200 | 152 | 290 |
| Noise (sones) | 0.8 | 1.4 | 2.0 |
| Power Consumption (Watts) | 43.7 | 42.9 | 63.6 |
| Energy Efficiency (CFMs/Watt) | 4.6 | 3.6 | 4.6 |
| Speed | 761 | 949 | 877 |
| Current | 0.34 | 0.33 | 0.53 |
| Power Rating (V/Hz) | 120/60 | | |



WhisperWall™ VENTILATION FAN



FV-08WQ1 70 CFM



Exterior Hood included

WhisperWall Key Benefits:

- UL listed for through-the-wall application
- 10" galvanized sleeve and steel exterior hood included

| WhisperWall Characteristics | FV-08WQ1 |
|---------------------------------|----------|
| Static pressure in inches w. g. | 0.03 |
| Air Volume (CFM) | 70 |
| Noise (sones) | 1.1 |
| Power Consumption (Watts) | 18 |
| Energy Efficiency (CFMs/Watt) | 3.9 |
| Speed | 860 |
| Current | 0.20 |
| Power Rating (V/Hz) | 120/60 |



WhisperComfort™ VENTILATION FAN



FV-04VE1 40/20 CFM or 20/10 CFM 2x4" Ducts
FV-WC04EVE1 Optional Exterior Wall Cap



Supply and exhaust air flows through a single exterior opening

WhisperComfort Key Benefits:

- ERV balances air pressure by supplying fresh exterior air while exhausting stale interior air
- MERV 6 supply filter and damper employed
- Exchange capillary core recovers temperature and moisture
- Dual setting air volume for 40/20 or 20/10 CFM
- Ideal for new air tight houses built to meet energy efficiency standards
- Compact size fits in ceilings and 2 x 8 construction
- Sensible Energy Recovery 66%
- Latent Energy Recovery 33%
- Does not require a condensation line or drain

| WhisperComfort Characteristics | FV-04VE1 | | |
|---------------------------------|----------|--------|--------|
| | 40 CFM | 20 CFM | 10 CFM |
| Static pressure in inches w. g. | 0.1 | 0.1 | 0.1 |
| Air Volume Exhaust (CFM) | 40 | 20 | 10 |
| Air Volume Supply (CFM) | 30 | 20 | 10 |
| Noise (sones) | 0.8 | <0.3 | N/A |
| Power Consumption (Watts) | 23 | 21 | 17 |
| Speed | 1479 | 1292 | 1095 |
| Current | 0.15 | 0.10 | 0.09 |
| Power Rating (V/Hz) | 120/60 | | |



WhisperLine™ VENTILATION FAN



FV-10NLF1 120 CFM 4" Duct
FV-20NLF1 240 CFM 6" Duct
FV-30NLF1 340 CFM 6" Duct
FV-40NLF1 440 CFM 8" Duct

WhisperLine Key Benefits:

- Remote mount in-line fan for single or multiple inlets
- Insulated housing to prevent condensation and noise
- Tapered duct adapter for easy connection
- 5 positions for installation
- Joist or truss attachment brackets included
- Suspension brackets included

| WhisperLine Characteristics | FV-10NLF1 | FV-20NLF1 | FV-30NLF1 | FV-40NLF1 |
|--------------------------------|-----------|-----------|-----------|-----------|
| Static pressure in inches w.g. | 0.2 | 0.3 | 0.4 | 0.2 |
| Air Volume (CFM) | 120 | 105 | 82 | 240 |
| Noise (sones) | 1.0 | 1.4 | 1.7 | 2.1 |
| Power Consumption (Watts) | 36 | 57 | 98 | 132 |
| Energy Efficiency (CFMs/Watt) | 3.3 | 4.2 | 3.5 | 3.3 |
| Speed | 1590 | 1260 | 1337 | 1150 |
| Current | 0.31 | 0.46 | 0.86 | 1.10 |
| Power Rating (V/Hz) | 120/60 | 120/60 | 120/60 | 120/60 |



Accessories

WhisperControl Condensation Sensor



On/Off—
FV-WCCS1-W (White), **FV-WCCS1-A**
(Light Almond)
On/Off/Light—
FV-WCCS2-W (White), **FV-WCCS2-A**
(Light Almond)

WhisperControl Condensation Sensor Features & Benefits:

- Humidity Control – Automatically turns on when relative humidity and temperature change is detected
- 30 minute countdown timer
- Manual On/Off Control
- Compatible with single-speed fans or fan/lights
- Stylish design with wall plate included
- 1 year limited warranty
- ENERGY STAR®, LEED for Homes, ASHRAE 62.2, and CALGreen compliant
- LED indicator

| Specifications | FV-WCCS1-W | FV-WCCS1-A | FV-WCCS2-W | FV-WCCS2-A |
|---------------------------------------|------------------|------------------|------------------|------------------|
| Ground | Grounding | Grounding | Grounding | Grounding |
| Feature | Blue LED Light | Blue LED Light | Blue LED Light | Blue LED Light |
| Amperage | 15 Amp | 15 Amp | 15 Amp | 15 Amp |
| Maximum Fan Load | 1/8 hp or 3 Amps | 1/8 hp or 3 Amps | 1/8 hp or 3 Amps | 1/8 hp or 3 Amps |
| Voltage | 120 Volts | 120 Volts | 120 Volts | 120 Volts |
| Termination | 6" Leads | 6" Leads | 6" Leads | 6" Leads |
| Connections (Copper Wire Connections) | Use #14 or #12 | Use #14 or #12 | Use #14 or #12 | Use #14 or #12 |
| Max. Fluorescent Light Load | NA | NA | 400 Watt | 400 Watt |
| Standard Certifications | UL/CSA Listed | UL/CSA Listed | UL/CSA Listed | UL/CSA Listed |
| Warranty | 1 Year | 1 Year | 1 Year | 1 Year |

WhisperControl Switches



1 Function Control

FV-WCSW11-W (White)
FV-WCSW11-A (Light Almond)

WhisperControl Switches Features & Benefits:

- Pilot light rocker visible when fan is on
- Back & side wiring terminals accept both solid & stranded wire for easier installation
- Full-rated current capacity with fluorescent or resistive loads. Motor capacity is 80% of switch rating
- Commercial grade
- Includes matching wall plate

| Specifications | FV-WCSW11-W/A |
|----------------------------|---|
| Ground | Self Grounding |
| Feature | Pilot Light - Illuminated ON - Req. Neutral |
| Amperage | 20 Amp |
| Voltage | 120 Volt |
| HP Rating | 1HP-120V |
| Terminations | Back & Side Wire |
| Standards & Certifications | UL/CSA Listed |
| Warranty | 10 Year Limited |

WhisperControl Switches



2 Function Control

FV-WCSW21-W (White)
FV-WCSW21-A (Light Almond)

WhisperControl Switches Features & Benefits:

- Multi-switch combination saves space and adds convenience
- Common feed shunted internally to all switches
- Includes matching wall plate
- Commercial grade
- Elegant styling provides multiple controls in a single-gang wall box

| Specifications | FV-WCSW21-W/A |
|----------------------------|-------------------------------------|
| Ground | Grounding |
| Feature | Single Pole/ Single Pole |
| Amperage | 15 Amp |
| Voltage | 120 Volt |
| Terminations | Quickwire Push-In, Back & Side Wire |
| Standards & Certifications | UL/CSA Listed |
| Warranty | 2 Year Limited |

WhisperControl Switches



3 Function Control

FV-WCSW31-W (White)
FV-WCSW31-A (Light Almond)

WhisperControl Switches Features & Benefits:

- Multi-switch combination saves space and adds convenience
- Common feed shunted internally to all switches
- Commercial grade
- Includes matching wall plate
- Elegant styling provides multiple controls in a single-gang wall box

| Specifications | FV-WCSW31-W/A |
|----------------------------|---------------------------------------|
| Ground | Grounding |
| Feature | Single Pole/ Single Pole/ Single Pole |
| Amperage | 15 Amp |
| Voltage | 120 Volt |
| Terminations | Quickwire Push-In, Back & Side Wire |
| Standards & Certifications | UL/CSA Listed |
| Warranty | 2 Year Limited |

WhisperControl Switches



4 Function Control

FV-WCSW41-W (White only)

Designed for model FV-11VHL2
Heater/Fan/Light/Night-light

WhisperControl Switches Features & Benefits:

- Single pole/double throw on-off-on top switch, two single pole on-off switches
- Multi-switch combination saves space and adds convenience
- Common feed shunted internally to all switches
- Commercial grade
- Includes matching wall plate
- Elegant styling provides multiple controls in a single-gang wall box

| Specifications | FV-WCSW41-W/A |
|----------------------------|--|
| Ground | Grounding |
| Feature | Single pole/double throw on-off-on top switch, |
| Individual Switch Amperage | two single pole on-off switches |
| Total Switch Amperage | 15 Amp |
| Voltage | 20 Amp |
| Termination | 120 Volt |
| Standards & Certifications | Quickwire Push-In, Back & Side Wire |
| Warranty | UL/CSA |

WhisperControl Switches



Preset Count Down Delay Off Timer Switch Logo

FV-WCDO1-W (White)
FV-WCDO1-A (Light Almond)

WhisperControl Switches Features & Benefits:

- Timer switch has four preset buttons options: 10-20-30 or 60 minutes
- LED light indicates countdown time and flashes two minutes before OFF warning
- Press and hold override timer function allows you to hold down the button until LED light indicates it is on
- Multi-switch combination saves space and adds convenience
- Common feed shunted internally to all switches
- Commercial grade
- Elegant styling provides multiple controls in a single-gang wall box
- Easy installation in single gang wallbox
- Includes matching wallplate

| Specifications | FV-WCSW21-W/A |
|----------------------------|-------------------------------------|
| Ground | Grounding |
| Feature | Single Pole/ Single Pole |
| Amperage | 15 Amp |
| Voltage | 120 Volt |
| Terminations | Quickwire Push-In, Back & Side Wire |
| Standards & Certifications | UL/CSA Listed |
| Warranty | 2 Year Limited |

Accessories

Ceiling Radiation Damper



PC-RD05C3



Radiation Damper Features:

- UL classification (UL standard 555C) for use in 1, 2 or 3 hour fire-rated floor/ceiling and roof/ceiling designs
- Available for 50 - 150 CFM fans
- 165° F fusible link
- High temperature, non-asbestos, reinforced fiber thermal fabric
- Galvanized steel frame

| Damper Model PC-RD05C3 | Fan Model approved for: |
|---------------------------|---|
| | WhisperCeiling: FV-15VQ5, FV-11VQ5, FV-08VQ5, FV-05VQ5 WhisperFit: FV-11VF2, FV-08VF2, FV-05VF2 WhisperValue: FV-10VS1, FV-08VS1, FV-05VS1 |

Passive Inlet Vent



FV-GKF32S1

Inlet Vent Features:

Panasonic Passive Inlet provides make-up air to help balance indoor vs. outdoor air pressure.

- Foam pad reduces outdoor noise and condensation
- Insulation lining to prevent condensation
- Durable ABS and PP resin body
- 7 stainless steel installation screws included
- Sturdy open/close lever
- 2-position air delivery

| | Passive Inlet | FV-GKF32S1 |
|----------------|-----------------------------|------------|
| Specifications | Air Volume Positions | 2 |
| | CFM Settings | 12 & 18 |
| Features | Open/Close Louver Setting | Yes |
| | Washable Air Filter | Yes |
| | Bug Screen | Yes |
| | 3" x 12" Sleeve Included | Yes |
| Installation | Body | ABS & PP |
| | Wall Opening (diameter) | 3 inch |
| | Installation Screw Included | Yes |

Designer Grilles



FV-GL3MTL

FV-GL3TDA

FV-GL3TDB



Designer Grille Features:

- Easy and affordable to change
- Change your grille to fit your room decor without compromising the performance and quality of the unit
- **Applicable Models**
 - WhisperGreen:** FV-13VKS3, FV-11VK3, FV-08VKS3, FV-08VK3, FV-05VK3
 - WhisperCeiling:** FV-15VQ5, FV-11VQ5, FV-08VQ5, FV-05VQ5
 - WhisperFit:** FV-11VF2, FV-08VF2, FV-05VF2
 - WhisperValue:** FV-10VS1, FV-08VS1, FV-05VS1 (For FV-GL3MTL only)

| | FV-GL3TDA | FV-GL3TDB | FV-GL3MTL |
|-------------------------------------|-------------|-------------|---------------------------|
| Characteristics | | | |
| Grille Size (inches sq.) | 13 | 14-1/5 | 13 |
| Shipping Gross Weight (lbs) | 1.1 | 1.3 | 1.5 |
| Trend Style Category | Traditional | Traditional | Commercial |
| Material | ABS | ABS | 26 Gauge Galvanized Steel |
| UL Approved ¹ | Yes | Yes | Yes |
| HVI Certified ¹ | Yes | Yes | Yes |
| Mfg. in ISO 9001 Certified Facility | Yes | Yes | Yes |

Fans with Built-in Controls — Performance Curves

Single Speed Fans — Performance Curves



FV-08VKM3/S3 80/0 CFM 4" or 6" Duct

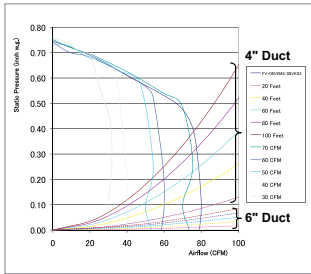

FV-13VKM3/S3 130/0 CFM 6" Duct

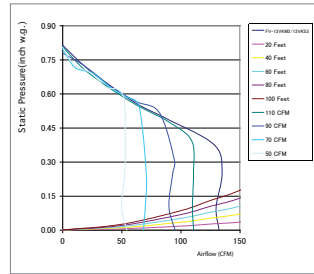

FV-05VK3 50 CFM 4" or 6" Duct

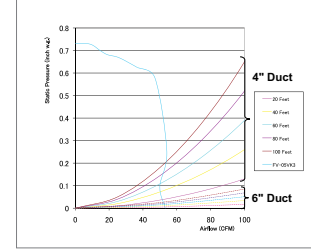

FV-08VK3 80 CFM 4" or 6" Duct

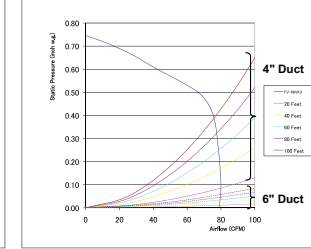

FV-11VK3 110 CFM 4" or 6" Duct

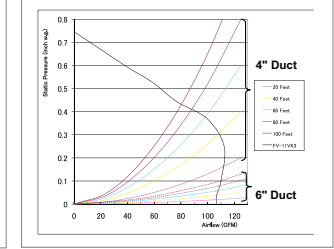

FV-08VQC5 80 CFM 4" or 6" Duct

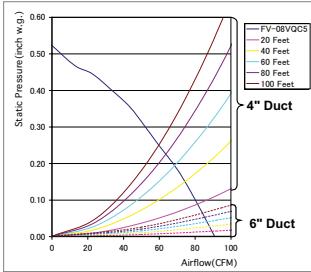

FV-11VQC5 110 CFM 4" or 6" Duct

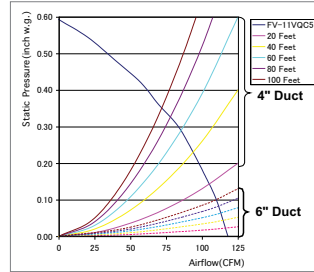

FV-05VFM2 50 CFM 3" Duct

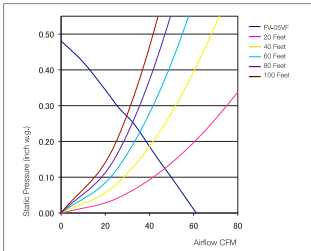

FV-05VFM2 50 CFM 4" Duct

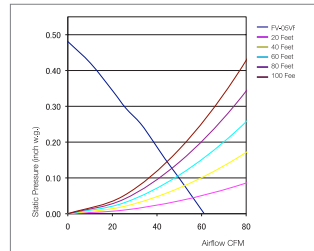

FV-08VFM2 80 CFM 3" Duct

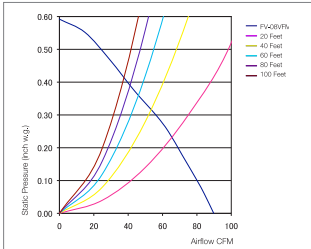

FV-08VFM2 80 CFM 4" Duct

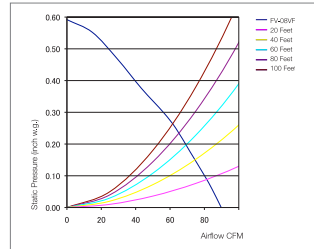

FV-05VQ5 50 CFM 4" or 6" Duct

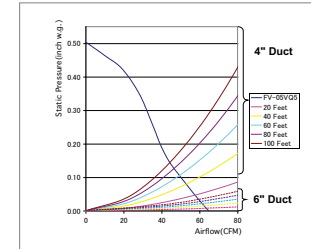

FV-08VQ5 80 CFM 4" or 6" Duct

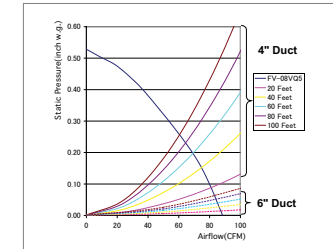

FV-11VQ5 110 CFM 4" or 6" Duct

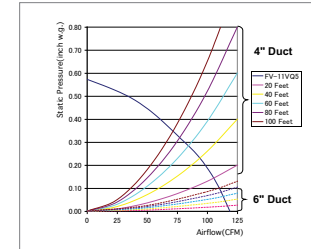

FV-15VQ5 150 CFM 6" Duct

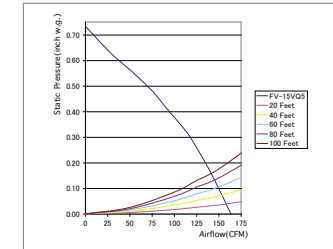

CFM based on HVI certification.

Single Speed Fans – Performance Curves (cont'd)

Fan/Lights with Built-In Controls – Performance Curves



FV-05VF2 50 CFM 3" Duct

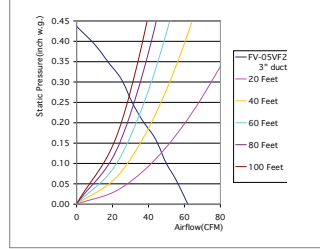

FV-08VF2 80 CFM 3" Duct

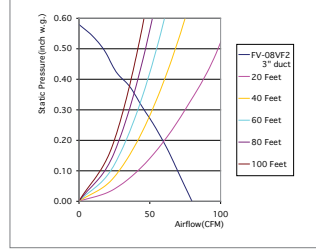

FV-11VF2 110 CFM 3" Duct

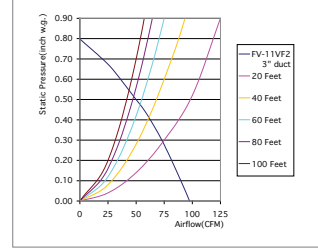

FV-05VF2 50 CFM 4" Duct

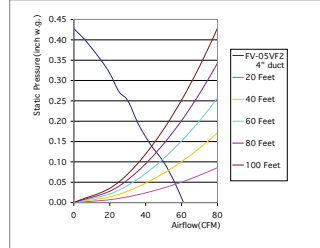

FV-08VF2 80 CFM 4" Duct

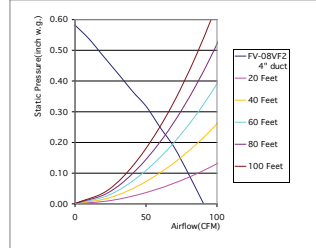

FV-11VF2 110 CFM 4" Duct

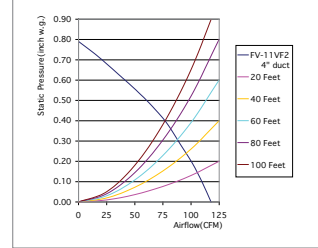

FV-08VKML3/SL3 80/0 CFM 4" or 6" Duct

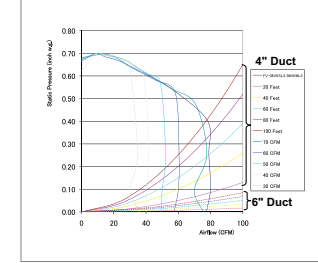

FV-13VKML3/SL3 130/0 CFM 6" Duct

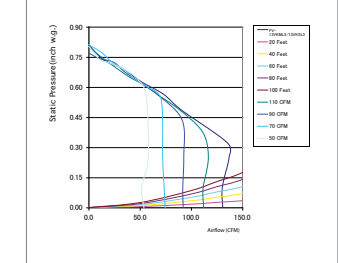

FV-08VQL5 80 CFM 4" or 6" Duct

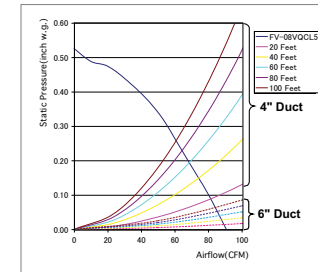

FV-11VQL5 110 CFM 4" or 6" Duct

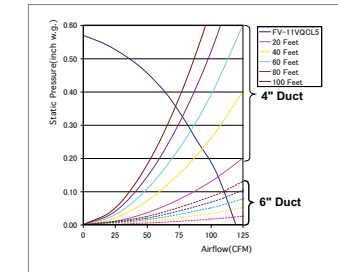

FV-05VS1 50 CFM 4" Oval Duct

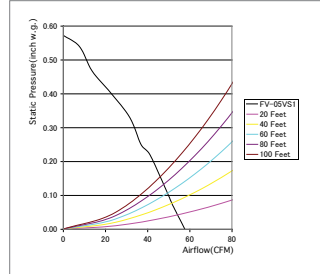

FV-08VS1 80 CFM 4" Oval Duct

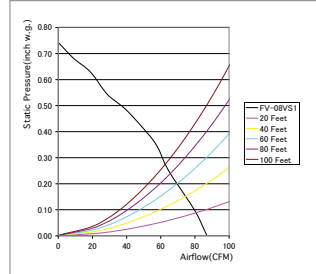

FV-10VS1 100 CFM 4" Oval Duct

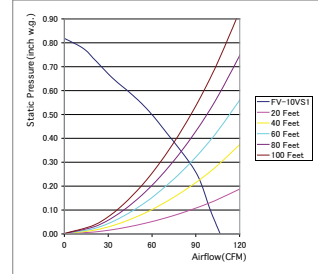

CFM based on HVI certification.

Single Speed Fans with Lights – Performance Curves

WhisperGreen-Lite™
VENTILATION FAN

FV-08VKL3 80 CFM 4" or 6" Duct

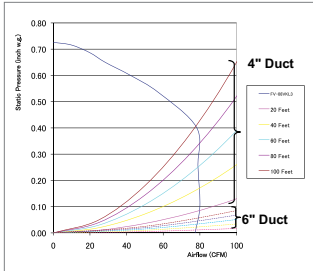

FV-11VKL3 110 CFM 4" or 6" Duct

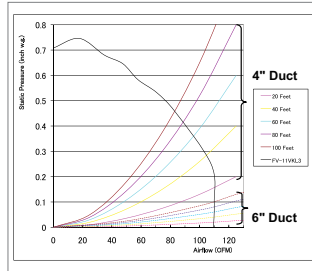

WhisperFit-Lite™
VENTILATION FAN

FV-05VFL2 50 CFM 3" Duct

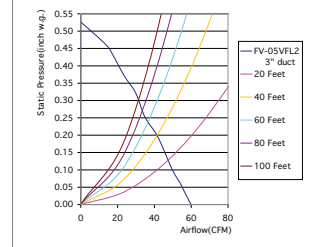

FV-08VFL2 80 CFM 3" Duct

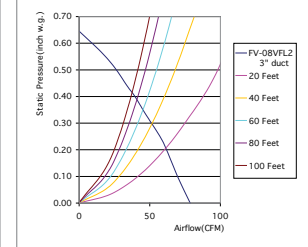

FV-11VFL2 110 CFM 3" Duct

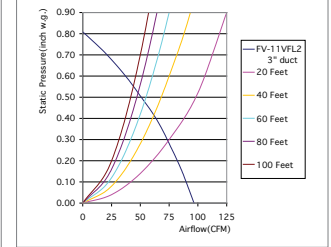

FV-05VFL2 50 CFM 4" Duct

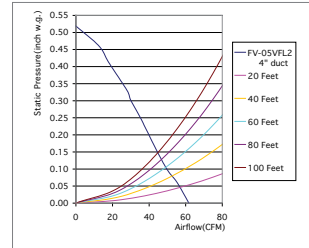

FV-08VFL2 80 CFM 4" Duct

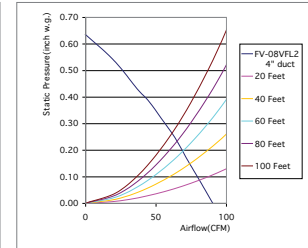

FV-11VFL2 110 CFM 4" Duct

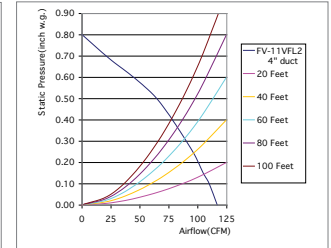

WhisperLite™
VENTILATION FAN

FV-08VQL5 80 CFM 4" or 6" Duct

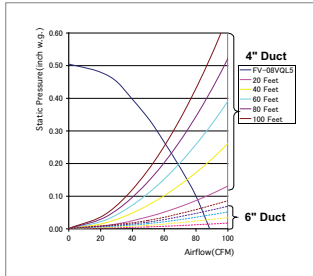

FV-11VQL5 110 CFM 4" or 6" Duct

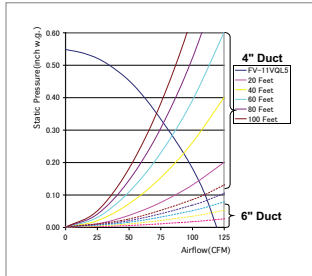

FV-15VQL5 150 CFM 6" Duct

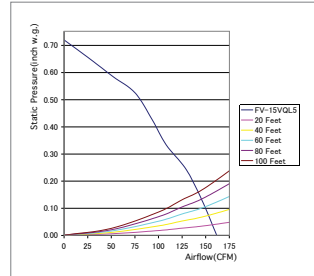

WhisperValue-Lite™
VENTILATION FAN

FV-08VSL1 80 CFM 4" Oval Duct

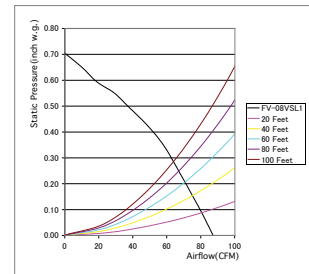

FV-10VSL1 100 CFM 4" Oval Duct

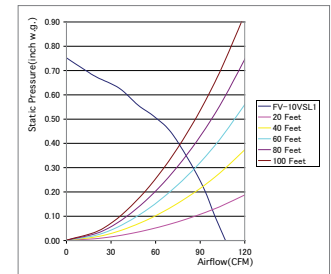

CFM based on HVI certification.

Specialty Fans – Performance Curves



FV-11VH2 110 CFM 4" Duct

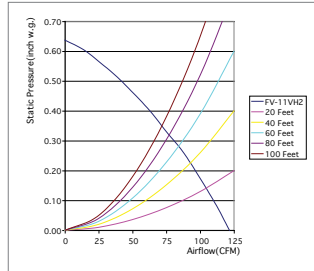

FV-11VHL2 110 CFM 4" Duct

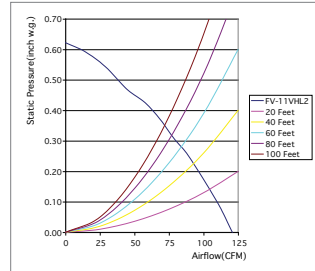

FV-10NLF1 120 CFM 4" Duct

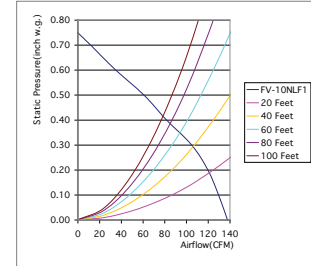

FV-20NLF1 240 CFM 6" Duct

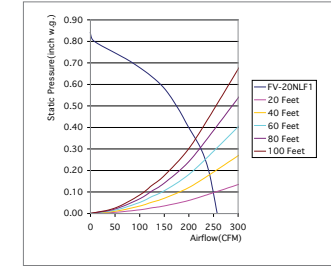

FV-20VQ3 190 CFM 6" Duct

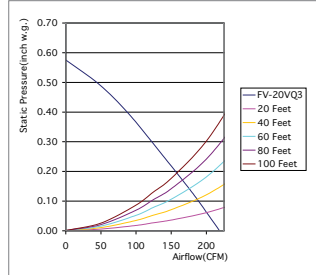

FV-30VQ3 290 CFM 6" Duct

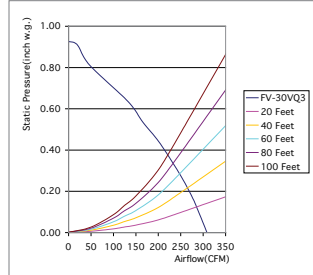

FV-40VQ3 380 CFM 6" Duct

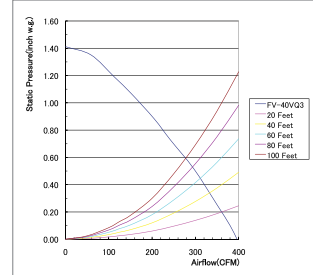

FV-30NLF1 340 CFM 6" Duct

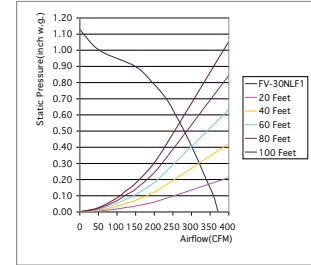

FV-40NLF1 440 CFM 8" Duct

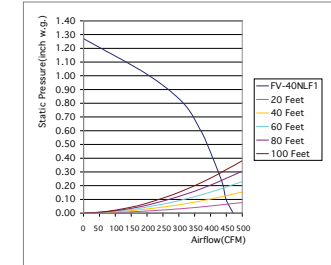

FV-04VE1 40/20 CFM or 20/10 CFM 2 x 4" Ducts

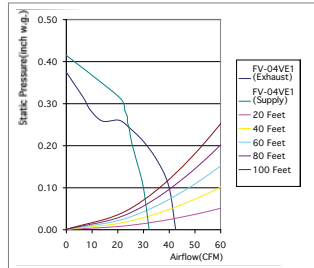

CFM based on HVI certification.

Fans with Built-in Controls — Dimensional Drawings

WhisperGreen™
VENTILATION FAN

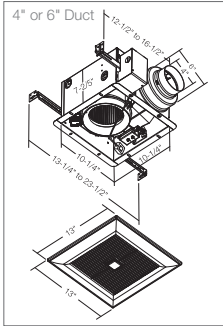

FV-08VKM3

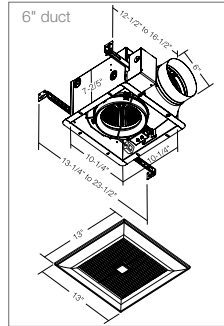

FV-13VKM3

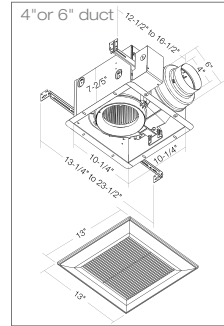

FV-08VKS3

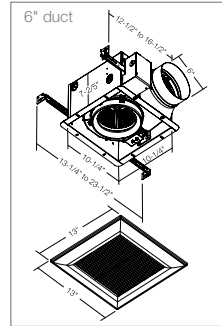

FV-13VKS3

Single Speed Fans — Dimensional Drawings

WhisperGreen™
VENTILATION FAN

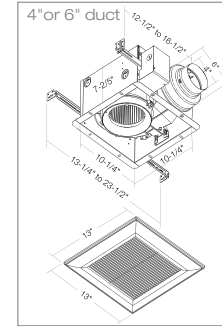

FV-05VK3 / FV-08VK3 / FV-11VK3

WhisperCeiling™
VENTILATION FAN

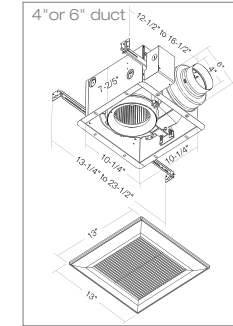

FV-05VQ5 / FV-08VQ5 /
FV-11VQ5

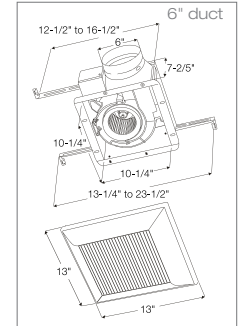

FV-15VQ5

WhisperSense™
VENTILATION FAN

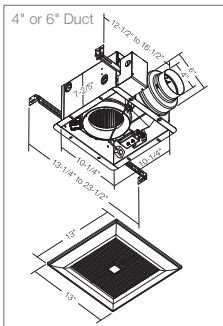

FV-08VQC5 / FV-11VQC5

WhisperWelcome™
VENTILATION FAN

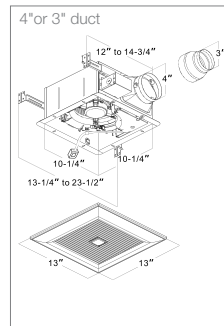

FV-05VFM2 / FV-08VFM2

WhisperFit™
VENTILATION FAN

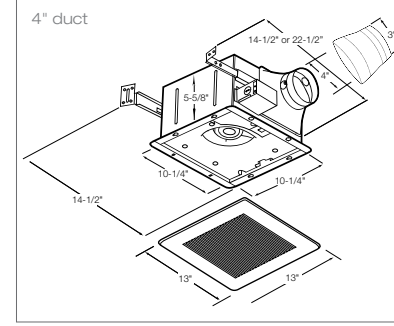

FV-05VF2 / FV-08VF2 / FV-11VF2

WhisperValue™
VENTILATION FAN

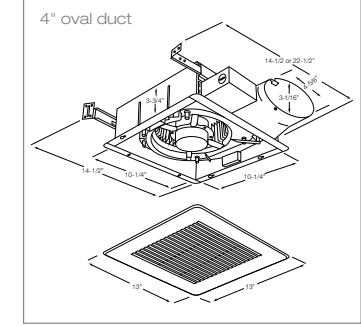

FV-05VS1 / FV-08VS1 / FV-10VS1

Fan/Lights with Built-In Controls — Dimensional Drawings

WhisperGreen-Lite™
VENTILATION FAN

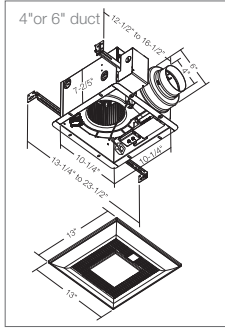

FV-08VKML3

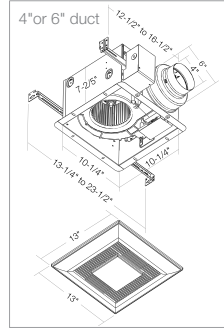

FV-08VKSL3

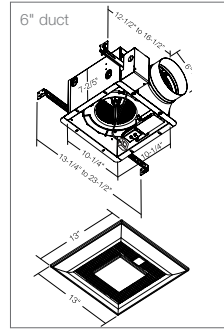

FV-13VKML3

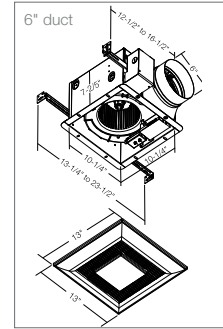

FV-13VKSL3

Single Speed Fans with Lights — Dimensional Drawings

WhisperGreen-Lite™
VENTILATION FAN

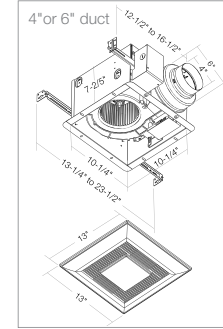

FV-08VKL3 / FV-11VKL3

WhisperLite™
VENTILATION FAN

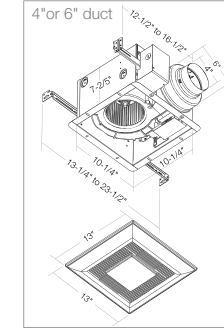

FV-08VQL5 / FV-11VQL5

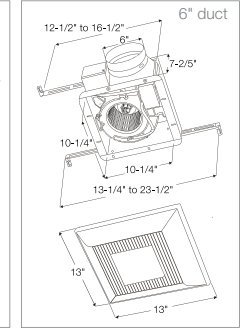

FV-15VQL5

WhisperSense-Lite™
VENTILATION FAN

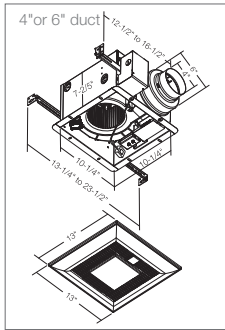

FV-08VQCL5 / FV-11VQCL5

WhisperFit-Lite™
VENTILATION FAN

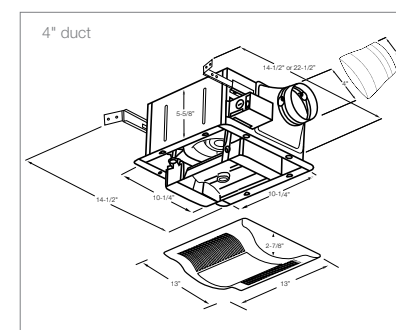

FV-05VFL2 / FV-08VFL2 / FV-11VFL2

WhisperValue-Lite™
VENTILATION FAN

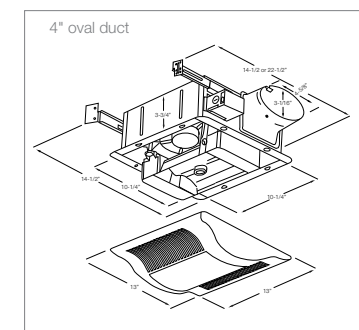

FV-08VSL1 / FV-10VSL1

Specialty Fans — Dimensional Drawings

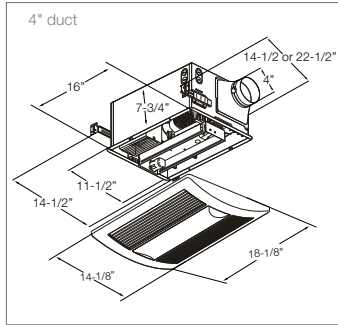

FV-11VHL2

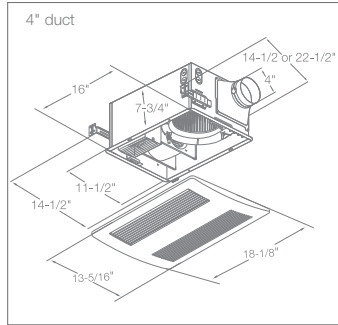

FV-11VH2

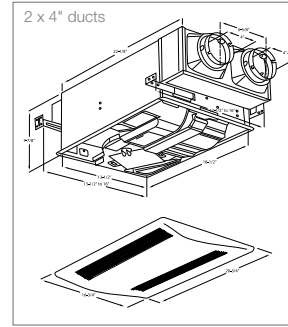

FV-04VE1

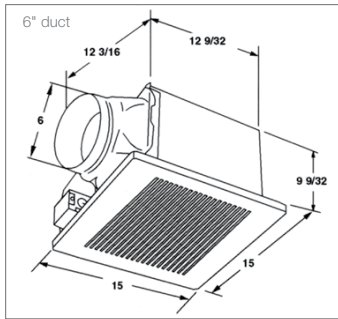

FV-20VQ3 / FV-30VQ3

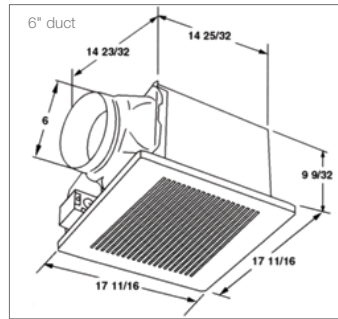

FV-40VQ3

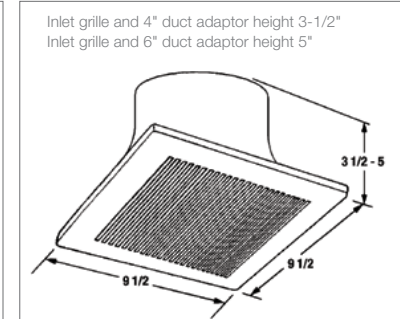
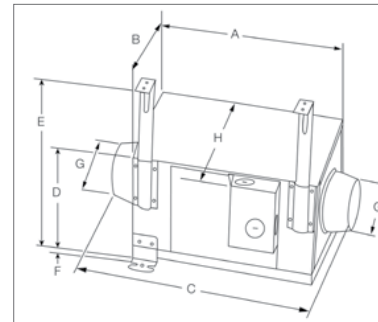

WhisperLine Dimensions

| Fan Model | A | B | C | D | E | F | G | H |
|-----------|-----------|---------|----------|---------|--------------------|-------|----|---------|
| FV-10NLF1 | 13-3/8" | 9-1/2" | 17-5/16" | 7-7/8" | 12-5/8" - 22-3/4" | 5/16" | 4" | 11" |
| FV-20NLF1 | 13-3/8" | 9-1/2" | 21-5/8" | 9-7/16" | 12-5/8" - 24-7/16" | 5/16" | 6" | 11" |
| FV-30NLF1 | 15-11/32" | 10-5/8" | 23-5/8" | 11" | 12-5/8" - 26" | 5/16" | 6" | 12-1/8" |
| FV-40NLF1 | 16-1/2" | 13-3/8" | 22" | 11" | 12-5/8" - 26" | 5/16" | 8" | 14-7/8" |

CFM based on HVI certification.



Sizing Information and Instructions

Equivalent Duct Length (EDL): The Equivalent Duct Length Table (Figure B) shows you how to calculate the equivalent straight duct length in order to overcome static pressure. The EDL chart helps ensure fan performs as expected under the airflow resistance caused by the listed components.

A ventilating fan's performance is plotted on a graph called a performance curve. The performance curve shows airflow in cubic feet per minute (CFM) along the horizontal axis and static pressure (resistance) along the vertical axis. Figure A shows how a performance curve works. The fan with a "Closed Duct" has high static pressure and no airflow; and the fan with "No Duct" has low static pressure and high airflow. In reality, an installed fan will be somewhere in between these two points.

Performance Curves are listed on **pages 26-33**.

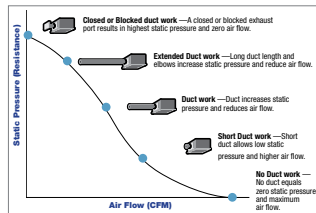

FIG. A

| | | Equivalent Duct Length | | | |
|----------|----------------|------------------------------|--------------------|--------------------|--------------------|
| | | Duct Diameter | | | |
| | | 3" | 4" | 6" | 8" |
| Duct | Smooth Metal | Same as measured duct length | | | |
| Material | Flex Aluminum | 1.25 x duct length | 1.25 X duct length | 1.5 X duct length | 1.5 X duct length |
| | Insulated Flex | 1.5 X duct length | 1.5 X duct length | 1.75 X duct length | 1.75 X duct length |
| Terminal | Wall Cap | 30 feet | 30 feet | 40 feet | 40 feet |
| Device | Roof Jack | 30 feet | 30 feet | 40 feet | 40 feet |
| Elbow | Adjustable | 15 feet | 15 feet | 20 feet | 20 feet |

FIG. B

Sizing and selecting a Ceiling Mounted Fan:

Proper sizing requires that you determine the needed CFM, the square footage of the room or home, and the length and type of duct.

Example: Sizing for an 8 ft x 10 ft x 8 ft ceiling bathroom using 12 foot long, 4 inch diameter aluminum flex duct, one elbow, one wall cap.

Step 1: Determine application

Bathroom = 1 CFM/square foot

Step 2: Calculate the area to be ventilated in square feet.

Assuming an 8 ft ceiling: room length x width = area in square feet

$$8 \text{ ft} \times 10 \text{ ft} = 80 \text{ sq ft}$$

Step 3: Calculate your required CFM

$$1 \text{ CFM} \times 80 \text{ sq ft} = \underline{80 \text{ CFM}}$$

Step 4: Use the Equivalent Duct Length chart above to calculate duct run.

4a. 12 ft aluminum flex duct x 1.25 = 15 ft

4b. One elbow = 15 ft EDL

4c. One wall cap = 30 ft EDL

$$15 \text{ ft} + 15 \text{ ft} + 30 \text{ ft} = \underline{60 \text{ ft EDL}}$$

This is the equivalent duct length (or resistance) the fan must overcome to move air through the duct to the outside.

Step 5: Review models in catalog pages to find a model with desired feature. Features may include light fixture, heater or low-profile housing.

Note: Check with your local building inspector to confirm that these methods are accepted in your area.



Ventilation Controls

Selecting a suitable control that runs ventilation at the proper time and duration will ensure that both the occupant's health and building structure are protected.

There are several types of manual and automatic controls that can be applied to ventilation systems. Some controls are more suitable for intermittent or continuous ventilation. Select Panasonic fans incorporate built-in speed, delay and occupancy controls, making them ideal for both intermittent and continuous ventilation.

Manual Controls: Manual controls require the occupant to activate the ventilation fan when needed. An example of a basic manual control is the Panasonic FV-WCSW11 On/Off rocker switch. There are other controls with functions available that may be more suitable to the occupant's lifestyle.

Delay timer: Shower curtains, towels, walls and cabinets retain moisture long after the occupant has finished and left the bathroom. One advantage of Panasonic FV-WCDO1 delay timer is that it continues to evacuate moisture and odor after the occupant has finished. WhisperGreen® and WhisperSense™ fans incorporate a delay timer that can be set within the range of 30 seconds to 60 minutes for the desired delay effect.

Manual timers: Electronic timers are more decorative and but allow the occupant to select a time duration with the push of a button. Electronic timers do not produce the sometimes annoying ticking sound that crank timers are known for. WhisperGreen and WhisperSense fans incorporate quiet electronic controls.

Occupancy (motion) sensors: Occupancy sensors are suitable for intermittent ventilation. An advantage is that the ventilation system will operate without having to rely on the occupant's interaction. The ventilation system will remain "on" and continue working for a duration after the occupant has left the room, much like a delay off timer. Select

WhisperGreen and WhisperSense fans have occupancy sensors integrated in the fan grille. Dehumidistats can be used to turn a ventilation system on/off when relative humidity reaches a certain level. These controls are most likely to be used in bathrooms to evacuate excessive moisture. Dehumidistats have a few disadvantages. One disadvantage is that seasonal changes in outdoor relative humidity necessitate seasonal readjustments to function optimally. Finally, it does not automatically remove odors. The new Panasonic FV-WCCS1 condensation sensor checks both Relative Humidity (RH) and temperature to anticipate condensation and exhausts humidity by turning on the fan. Also, Panasonic's new WhisperSense fans include both motion and humidity sensors for ultimate moisture control.

Automatic timers: Automatic timers operate fans at programmed times throughout the day. Typically a 24-hour programmable timer is used to run a fan in morning and evening hours when there is a high demand for ventilation. For continuous ventilation, the control can be programmed to operate throughout the day to help evacuate any accumulation of VOCs or other indoor air pollutants.

Controls can also be used in combination with each other to provide both intermittent and continuous ventilation. For example, a programmable timer may be used to cycle the fan on and off throughout the day to address overall indoor air quality. Select WhisperGreen fans have been designed as an ideal double-duty fan providing both intermittent and continuous ventilation with a DC motor activated by built-in speed, delay and occupancy controls. *The key to selecting the right control or combination of controls is to first understand the occupant's lifestyle and ventilation needs. Then select a control that provides proper ventilation with little or no involvement by the occupant.*



ENERGY STAR®

www.energystar.gov

The ENERGY STAR program was created by the U.S. Environmental Protection Agency (EPA) and the U.S. Department of Energy (DOE) to help customers identify products that can save them money and protect the environment by saving energy. When it comes to ventilation fans, ENERGY STAR qualified products feature super-quiet operation (low sone levels) and high CFM to Watt efficiency. As an ENERGY STAR Partner of the Year for 2010 and 2011, all Panasonic ventilating fans exceed ENERGY STAR standards

| ENERGY STAR Specifications | Min. CFMs/Watt | Max. Sones | Min. Warranty | Rated Airflow (0.25 in. w.g.)* |
|----------------------------|----------------|------------|---------------|--------------------------------|
| Bath Fans -10 to 89 CFM | 1.4 | 2.0 | 1 year | 60% |
| Bath Fans -90 to 130 CFM | 2.8 | 2.0 | 1 year | 70% |
| Bath Fans -140 to 500 CFM | 2.8 | 3.0 | 1 year | 70% |
| In-Line Fans | 2.8 | N/A | 1 year | N/A |

where guidelines exist and have been labeled accordingly. Panasonic ventilation fans may qualify for an energy saving rebate. Rebate programs are often provided by local utility companies and based on ENERGY STAR guidelines. Check with your local utility company or state ENERGY STAR Homes Program for details.

HOME VENTILATING INSTITUTE

www.hvi.org

All Panasonic ventilation fans are tested and certified by the Home Ventilating Institute (HVI). The HVI label is your assurance that the certified airflow and sound rating of Panasonic ventilation fans are the results of testing by an independent laboratory.

HVI is a non-profit association comprised of manufacturers of home ventilation products. HVI offers a variety of services including, but not limited to, test standards, certification programs for airflow, sound and energy performance. For more information about HVI contact:

Home Ventilating Institute - HVI
 Email: hvi@hvi.org
 Website: www.hvi.org
 1000 North Rand Road, Suite 214
 Wauconda, IL 60084
 Phone: (847) 526-2010
 Fax: (847) 526-3993



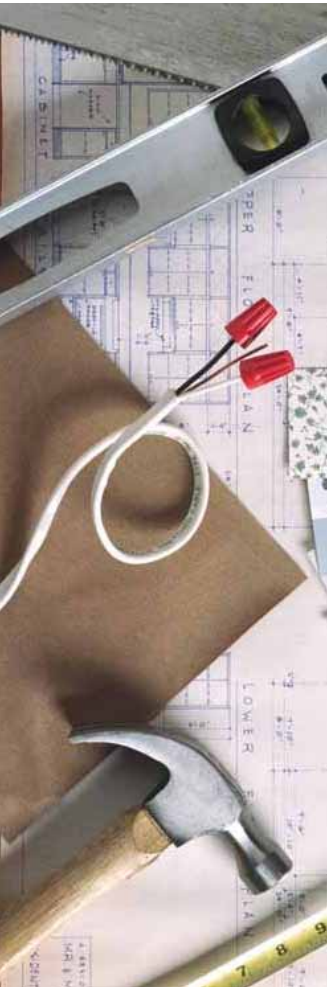

Installation

A practical guide to Panasonic fan installation

Proper fan installation is necessary to optimize performance. The following points outline installation techniques to help achieve optimum performance.

IMPORTANT: In order to reduce elbows and optimize fan performance, install the fan with the exhaust port pointed in the direction of the termination point. Be sure to use the duct diameter size specified for the selected fan. Reducing the duct diameter (at any point in the duct run) will create substantial static pressure and reduce the fan's performance by as much as 90%.

Selecting Duct: A smooth surface duct allows for optimum airflow. See Figure C. For best results, use galvanized sheet metal or possibly PVC. Flexible aluminum duct is durable, easy to install and often used. However, the ridges in aluminum flexible duct increase static pressure and can reduce air flow and fan performance. This results in lower CFMs, higher noise levels and higher energy consumption. The degree to which performance is affected depends on the length of duct, number and degree of elbows.

Sagging or weaving a fan duct will also increase static pressure and reduce a fan's performance. When using a flexible aluminum duct, support the entire length of the duct with braces or hangers to keep it as straight as possible for the entire run. If the duct lies across the attic, do not allow it to sag between each joist. Also, avoid weaving duct through trusses.

Using dryer duct connectors made of nylon or vinyl is not recommended due to high static pressure caused by its ridges and curvature. Insulated flexible duct must be fully extended to avoid added resistance.

Trouble Shooting Advice:

1. During fan installation, the tape on the duct connector holding the damper shut must be removed.
2. Confirm with your contractor if screws were used to attach the duct to the fan. The damper may not open if obstructed by screws.
3. Check that the backdraft dampers on wall caps and roof jacks are able to move freely. Routine inspections are recommended as birds and other pests may inhabit these areas.
4. Ductwork must be connected securely to wall caps and roof jacks.

Elbows: Rule number one is to avoid elbows and bends whenever possible. However, the fact is that many installations require at least one elbow, as shown in Figure D. There are two precautions you can take when installing elbows to achieve optimum airflow.

First, allow a 2-3 foot straight run out of the fan before the first elbow. This allows airflow to be uniform before passing through the first elbow. An installation that has a 90-degree elbow immediately after the fan exhaust port will cause air to flow back into the fan. This will reduce fan performance and increase noise. (Figure D)

FIG. D

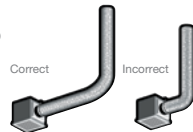

Second, use a long radius angle, as shown in Figure E, to help ensure optimum airflow and minimum airflow noise.

FIG. E

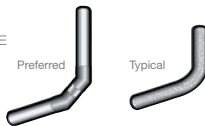

The shortest, smooth inner surface duct with the least number of elbows will provide optimum fan airflow

FIG. C

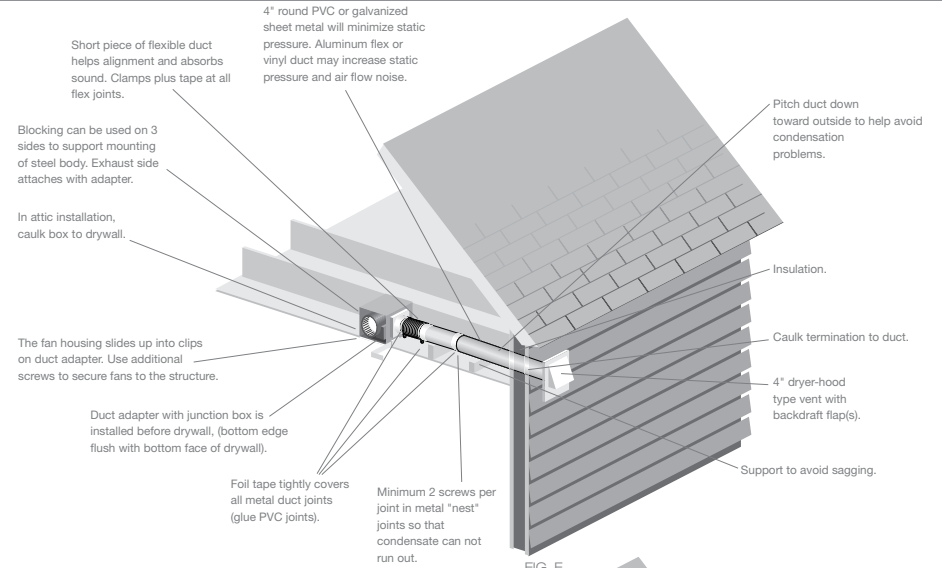
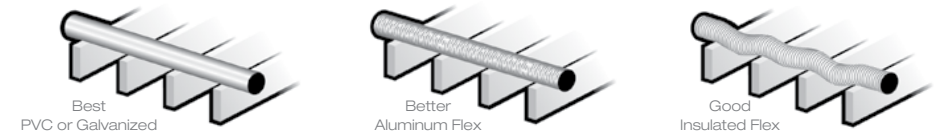
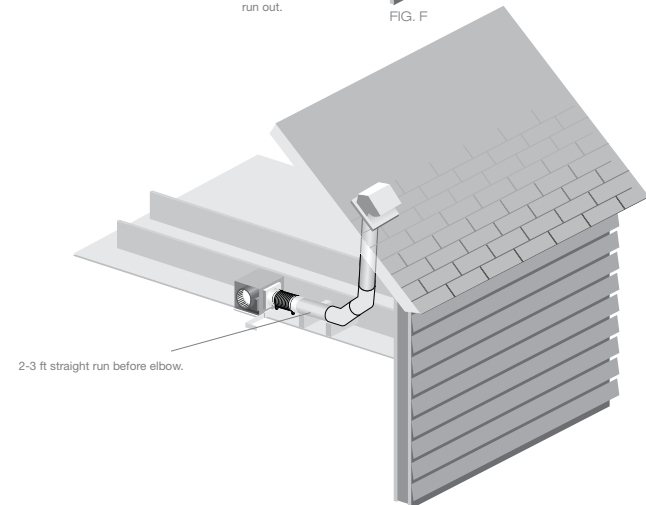

FIG. F

FIG. G



Note: If duct is in the attic, to avoid possible condensation problems, be sure it is either under loose fill insulation or it is fully insulated to minimum of R-6 with duct wrap.

Green Building Programs & Green FAQs

Green Building Programs

Green building is the practice of increasing energy efficiency while promoting economic health for people and the environment. Effective green building can reduce operating costs through less energy consumption; improve occupant health by enhancing indoor air quality and lessening the impact on the environment.

ASHRAE 62.2-2010

There are several green building programs within the United States and nearly all adhere to the standards set by the American Society of Heating, Refrigerating, and Air Conditioning Engineers (ASHRAE) for the HVAC industry. ASHRAE Standard 62.2 is the national ventilation standard of design for low-rise residences up to three-story multi-family buildings. 62.2 requires continuous mechanical ventilation for the entire house to be 7.5 CFM per bedroom (master bedroom x 2) plus 1 CFM per 100 sq. ft. with some level not to exceed 1.0. Panasonic's full line of ventilation fans including

WhisperGreen and WhisperComfort are affordable and are an efficient way to meet this ventilation standard.

LEED and LEED for Homes

The US Green Building Council (USGBC www.usgbc.org) offers the Leadership in Energy and Environmental Design (LEED) program for commercial buildings and the LEED for Homes program for residential buildings. Neither program offers specific product certification, but both require mechanical ventilation adopted after ASHRAE 62.2.

ENERGY STAR® Homes Program

The US Environmental Protection Agency (EPA) operates the ENERGY STAR program, including the ENERGY STAR® Homes Program. This program offers certification of the home as energy efficient based on an evaluation of energy use and construction features. Even though it does not require a full ventilation strategy, EPA's Indoor airPLUS (IAP) is an option to help builders meet the growing consumer preference for improved indoor air

quality. The IAP requires compliance with ASHRAE 62.2, so Panasonic's WhisperGreen is the product of choice.

California Title 24

As the required code for California, Title 24 is the shorthand name for the Building Energy Efficiency Standards for Residential and Non-Residential Buildings. Developed by the California Energy Commission and first published in 1978, the standards were recently updated for 2008 and will be effective in 2009, including the requirement to meet ASHRAE Standard 62.2.

National Association of Home Builders (NAHB) Green Building Standard

A voluntary standard developed by NAHB to provide a design guide and rating system for houses. Similar to the LEED for Homes program but less stringent, it has both required and optional measures that help show a house is "green". The more options utilized such as fulfilling ASHRAE 62.2 provides a higher rating.

Green FAQs

What does Built Green or other builder program certification mean how can Panasonic help?

Programs like LEED for Homes and ENERGY STAR® IAP, all require various levels of insulation, use of renewable building and finishing products. They also require compliance with the ventilation requirements of 62.2.

ASHRAE 62.2 allows the designer or builder to choose the method that fits their project, climate, or budget. It only sets the continuous rate and provides guidance on how to increase the flow to allow for intermittent

operation. Essentially, the higher rate is the reciprocal of the run time. If it operates one-third of the time, it must be increased to three times the continuous rate in the table. The easiest way to meet the requirements is to use a WhisperGreen fan operating continuously. Most of the single speed Panasonic fans under 1.0 can be used to meet 62.2, but the rated flow at 0.25 inches of water gauge must meet the required flow. So WhisperGreen models are the preferred choice.

Where is my make-up air coming from if the house is airtight?

All houses leak to some extent. ASHRAE 62.2 assumes an average new construction tightness level that is based on national testing and that will allow some leakage. Air leaks in (if exhausting) or out (if supplying) of the house when the fan operates, through the cracks and holes in the building between building materials, around windows and doors, and through utility penetrations. While not required by 62.2, through-the-wall inlets from Panasonic and others can be installed to ensure some of the leakage happens through those inlets.

Am I creating a negative pressure when exhausting air all the time?

The low exhaust rates required by 62.2 will virtually never create enough negative pressure to cause a combustion device to backdraft. High flow fans, such as large range hoods and clothes dryers, can create enough negative pressure to create a backdraft if natural draft combustion devices are used in a tight house. ASHRAE 62.2 sets a limit on how much total exhaust can be tolerated.

What makes a WhisperGreen fan a Green product?

The Green concept is a combination of energy efficiency, sustainability, improved interior environment (IAQ), and operating cost. WhisperGreen fans are the most energy efficient and quietest products on the market and the six year warranty and low energy use ensure sustainability.

Why can't I turn the WhisperGreen models with built-in controls off?

Your fan is designed to run 24 hours a day, 365 days a year using very little electricity. Your new home has been built to be very "tight" and energy efficient. While this helps on your energy costs, it can also lead to poor indoor air quality. By having a fan run constantly at a low speed, stale indoor air is continuously being ventilated and replaced by fresh air.

If the fan is running all day, aren't I wasting electricity?

The WhisperGreen fan features a DC motor, which makes very efficient use of electricity. Your fan, operating at 50 CFM continuously, uses 6.6 Watts of electricity. Using the national average kWh rate of \$.1105, it costs \$6.39 per year to have a fan that provides indoor air quality.

What does the motion sensor or the switch on WhisperGreen models with built-in controls do?

When the motion sensor senses motion, or when the switch is turned on, the fan boosts from its low, continuous ventilation speed to its high "spot" ventilation speed. The WhisperGreen fan has a high speed of 80 Cubic Feet per Minute. When the fan is in this mode it is operating as a traditional bathroom

exhaust fan.

When I turn my switch to the "on" position or when the motion sensor is blinking green, I don't hear a big boost in speed.

Another feature of the WhisperGreen fan is "SmartFlow" technology. Static pressure, the resistance that lies within the duct system and point of exhaust, can severely inhibit a standard bath fan's performance. For example, a fan designed to deliver 50 CFM of airflow might only be operating at 31 CFM due to high static pressure. "SmartFlow" technology allows the fan motor to react to higher static pressure situations, so that when set at 50 CFM, you might not hear a big boost in speed, but the fan is delivering 50 CFM of air flow.

When I turn the switch to the "off" position or when the motion sensor is not in use, why doesn't the fan slow down right away?

Your WhisperGreen fan features a built-in delay-low timer. This allows the fan to operate at the higher speed for a longer time to help remove excess moisture from the bathroom, for example, after a shower.

Required Continuous Ventilation Rate (CFM)

| Floor area | 0-1 BR | 2-3 BR | 4-5 BR | 6-7 BR | >7 BR |
|------------|--------|--------|--------|--------|-------|
| <1500 | 30 | 45 | 60 | 75 | 90 |
| 1501-3000 | 45 | 60 | 75 | 90 | 105 |
| 3001-4500 | 60 | 75 | 90 | 105 | 120 |
| 4501-6000 | 75 | 90 | 105 | 120 | 135 |
| 6001-7500 | 90 | 105 | 120 | 135 | 150 |
| >7500 | 105 | 120 | 135 | 150 | 165 |

Sizing example (based on ASHRAE 62.2):

Two Bedrooms at 1600 SQ. FT.

Master Bedroom (7.5 CFM X 2) = 15 CFM

Second Bedroom = 7.5 CFM

1600 SQ. FT. X .01 = 16 CFM

Total 38.5 CFM

To comply with ASHRAE 62.2, a WhisperGreen FV-08VKM3 set at 40 CFM provides the ideal solution. Or to keep air pressure balanced inside the home, WhisperComfort provides supply air and complies with 62.2 by setting the exhaust fan at 40 CFM. For larger homes or whole house ventilation, a combination of WhisperComfort and/or WhisperGreen continuous ventilation fans can be utilized to fulfill the standards set by ASHRAE 62.2.

FAQs

Frequently Asked Questions

1. What is a sone?

A sone is an internationally recognized measurement of sound output. The smaller the sone, the more quiet it is. Likewise, the higher the sone, the louder the sound. According to HVI, one sone is equivalent to the sound of a quiet refrigerator.

2. What is CFM?

CFM, or Cubic Feet per Minute is a measurement of rate of air flow. The larger the CFM, the more powerful the fan.

3. What is static pressure?

Static pressure is a measure of the resistance against flow as the fan pushes air through a duct. Static pressure is measured in inches of water column or water gauge (w.g). It is expressed as 0.1" w.g. or 0.25" w.g. to show that the resistance is equal to a column of water one-tenth or one-quarter of an inch tall. Most bath fans sold in North America are rated and certified at 0.1" w.g. by the Home Ventilating Institute (HVI).

4. Why are Panasonic Fans so quiet?

Tip Speed.

Fan noise comes from the amount of the blower wheel blade tip speed – the tip speed is in proportion to the revolutions per minute (RPM) of the wheel or fan blade. A small wheel turning very fast will create more noise than a large wheel turning more slowly for a given airflow. Panasonic fans use a compact blower wheel with aero dynamic blades that moves a large amount of air at reduced RPMs. The

Panasonic blower wheel is designed more efficiently than most competitor models, so it turns at lower RPMs, reducing tip speed and noise.

Quiet Motor.

Panasonic is the first ventilation fan manufacturer to incorporate a DC motor in residential mechanical ventilation fans. Panasonic WhisperGreen series incorporates a totally enclosed DC motor designed for extremely quiet, energy efficient operation.

All other Panasonic fan series incorporate a totally enclosed four-pole condenser motor, which is an advanced version of a Permanent Split Capacitor (PSC) motor. These are among the most energy efficient fan motors made. The four-pole design helps the fan to rotate smoothly and evenly due to a more stable electrical field that keeps the fan shaft turning more evenly than shaded-pole motors used in mid-range fans or C-frame motors used in inexpensive fans.

5. What makes Panasonic Fans so highly energy efficient?

The input wattage readings on the Panasonic fans are among the lowest in the industry. This means that for a given

airflow, Panasonic fans will use fewer kilowatt hours and cost less to operate than other fans. This lower wattage draw is accomplished in a number of ways:

Unique Motor Design.

Panasonic's DC brushless motor provides unparalleled energy efficiency with its magnetic rotor and print circuit board. The magnetic rotor prevents energy loss while standard AC motors that utilize aluminum die cast rotors expend energy. Also, Panasonic's DC motor is the only one to incorporate a print circuit board containing a unique IC chip which monitors and directs the RPM of the fan blade. The combination of these two unique features allows the DC motor to have higher energy efficiency than an AC motor.

Panasonic uses a four-pole condenser motor, which is composed on a main coil and a sub coil. The coils in a motor are essentially small electromagnets that are turned on and off to create an electrical field to "pull" the fan shaft around, making the fan blower wheel turn. The condenser is connected with the sub coil, which helps with rotation. The condenser acts like a capacitor to store electrical energy and deliver it quickly and in exact amounts to the coil. This improves the electrical efficiency of the motor and reduces power draw.

Selective Application.

Panasonic builds its own motors and components, which means tight control over quality. Panasonic engineers also optimize efficiency by matching the exact motor characteristics with the desired performance of the fans.

6. Why do Panasonic Fans have such a long life?

Panasonic fans are designed to give the consumer trouble-free continuous operation for many years. These fans utilize high quality components and permanently lubricated motors. This leads to fans that provide a long operational life because their components wear very slowly. That is why Panasonic stands behind its products with one of the longest warranty periods in the industry.

Motor Production.

Panasonic motor production is fully automated, with an automatic defect detecting system. The quality assurance program is exemplary, leading to a defect rate of less than 0.0006%.

ISO 9001 plant.

The production facilities that build Panasonic fans have earned the distinction of being recognized by the International Standards Organization (ISO) under the ISO 9001 Quality Assurance program. Meeting ISO 9001 means that these factories have met the highest quality standards in the world.

Fan Housing.

The fan housing is made of heavy-gauge zinc-galvanized steel and painted to protect it from rust.

7. Can insulation material be used over fans installed in the ceiling?

YES. Loose fill or batt insulation can be placed directly over the fan housing in the attic. Panasonic fans and fan/light combination units do not create

excessive heat that is a common problem with recessed light fixtures or some competitors' fan/light combinations. Our efficient, cool-running motors and our fluorescent bulbs do not create enough ambient heat to be subject to these limitations.

8. Can a Panasonic fan be used over a bathtub and in showers?

YES. All Panasonic fans, with the exception of heater and Spot ERV models, are listed by Underwriters Laboratories for installation over tubs and showers, provided they are protected by a Ground Fault Circuit Interrupter (GFCI). GFCI is mandated by the National Electrical Code. While not specifically listed by UL as an application, the fan can also be installed in a steam shower enclosure. Keep in mind, however, that any ventilation device located in a damp environment such as a shower enclosure may have a reduced life due to the high humidity and potential for corrosion. Fans installed in a high humidity environment should be operated for longer periods of time to ensure the removal of the moisture and to reduce the potential for condensation in the fan body or ducting.

9. Can a Panasonic fan be used above a kitchen range?

No. Panasonic fans are not currently rated by UL for above-range installation since it was not designed to handle both grease and high temperature. However, Panasonic fans can be used to provide auxiliary kitchen ventilation. An approach that works well in large kitchens is to use a ducted range hood or downdraft

exhaust and a Panasonic ventilation fan to exhaust the general odors and moisture in the greater kitchen area.

10. Why are Panasonic fans not required to be IC rated?

Fans are not required by UL to be IC (Insulation Contact) rated because they do not have high temperature sources like recessed can lights. The Panasonic fan/light combo units use fluorescent lamps that are mounted in a light kit that is considered to be surface mounted, so they do not create high temperatures within the fan housing that would require an IC rating.

11. What's better, a motion sensor or humidity sensor?

While the humidity sensor checks the amount of moisture at the ceiling, a motion sensor "sees" the occupant coming into the room. The humidity sensor has to be set to either Rate of Rise or Relative Humidity. Depending on how the fan is set up, it may or may not turn on in certain conditions. For instance, if set for Rate of Rise (how quickly moisture builds up in a room), it might not turn on at all when there is a slow, steady build up of humidity over time. On the other hand, a motion sensor will go on once it senses motion to capture both moisture, odors and contaminants from the cleaners and chemicals that may be kept underneath the sink. Panasonic's new WhisperSense fans include both motion and humidity sensors for ultimate moisture control.

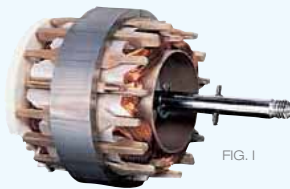

FIG. 1

