



The Original

RAM BIT

Plastic Fitting Saver

Works on PVC or ABS Fittings



Makes in-line repairs and installations.
Reams plastic pipe squarely and accurately below the surface or finished grade.
Ram Bit leaves fittings clean and ready for solvent welding.

SAVES

- Plastic Fittings
- Welded Ball Valves

SAVES TIME

- Cuts 3" & 4" DWV flush, below slab or sub-floor
- Repairing irrigation and swimming pool manifolds
- Repairing sprinkler risers
- Repairing freeze damaged plastic pipe





RAMBIT



Works On:
ABS DWV, PVC DWV,
PVC PRESSURE, CPVC,
RIGID PVC ELECTRIC CONDUCT



PART NUMBER	SIZE	CLASS 200*	SCH 40	SCH 80	DRILL SIZE
3237	1/2"		✓	✓	3/8" or heavy duty 3/8" rechargeable
3239	3/4"	✓	✓	✓	
3241	1"	✓	✓	✓	
3242	1-1/4"	✓	✓	✓	
3243	1-1/2"	✓	✓	✓	
3244	2"	✓	✓	✓	
3253	3"	✓	✓		1/2" variable
3254	4"		✓		

Replacement Parts

SIZE	BLADE ONLY	ARBOR W/NUT
1/2"	3204	3200
3/4"	3208	3200
1"	3213	3200
1-1/4"	3219	3201
1-1/2"	3225	3201
2"	3231	3201
3"	3256	3252
4"	3262	3252



The Drain Key™

Removes Corroded Bath Tub Drains

U.S. Patent 6,282,999

It's unique expanding design allows The Drain Key to internally grip in a 360° pattern. The drain Key's steel shoes will not mar chrome or special finishes. Installs and removes tub drains, closet spuds and pipe nipples.

Expands with a crescent wrench to unlock or install:

- Bathtub drains
- 1-1/4" or 1-1/2" Trap (dirty arm) nipples
- 1-1/4" or 1-1/2" closet spuds
- Jr. basket strainers, Jr. duo strainers, tray plug drains and duplex strainers

*Interchangeable steel Drain Key™ shoes sold separately

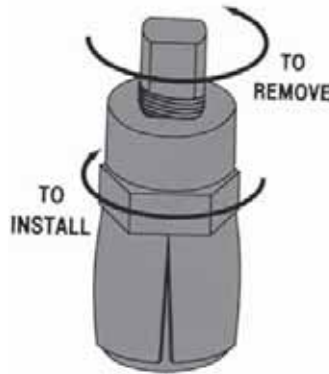

PART NUMBER	VOLTS
4500	Drain Key
4508	Replacement set of 3 shoes only

Smart Dumbbell - The Original

The Original and Still The Best!

Fits all 17 modern tub drain configurations

Installs and removes tub drains and closet spuds



- Installs or removes drains without crossbars (Kohler, American Standard)
- Heavy duty die-cast aluminum
- Prevents scratching of decorative finishes
- Either a crescent wrench or large phillips screwdriver can be used to turn the tool
- Saves time, money and aggravation
- 6" length



PART NUMBER
4554



Quick Nutcracker

Quickly removes corroded 1/2" zinc locknuts from faucet shanks.

- Heat treated cutter blades
- Ball thrust bearings
- Durable black oxide finish
- Will work on faucet shanks with only three threads showing

For use on:

- 1/2" Shank single basin faucet
- 1/2" Shank centerset faucet
- 1/2" Shank kitchen faucets



U.S. Patent 4,365,413



PART NUMBER	VOLTS
7000	Nutcracker ONLY
7010	Nutcracker Ratchet & Extension

Moen® Stem and Cartridge Puller - The Original - 2-in-1 Tool

Removes Moen® stems and Moen® cartridges from faucets and shower valves. Also removes the Posi-Temp® tub/shower cartridge.

- Removes brass cartridges
- Removes outer body of stems
- Removes plastic stems & cartridges
- Precision made
- High quality steel components
- One piece construction
- Easy to use

• Pulls cartridge complete

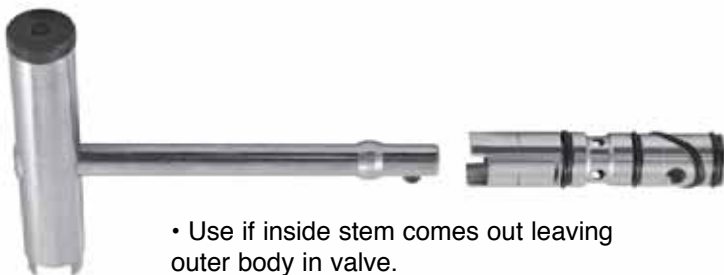
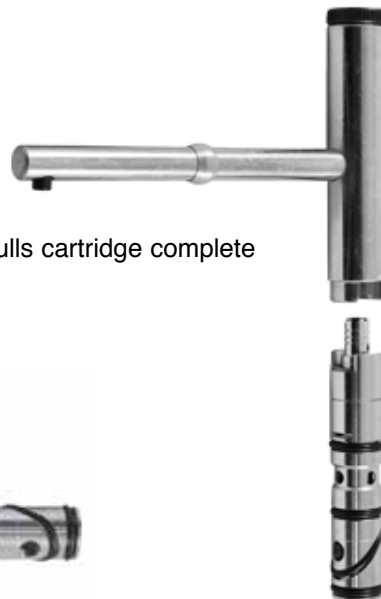

• Use if inside stem comes out leaving outer body in valve.

PART NUMBER
7040



KWIK TITE WRENCH

Get a grip on the installation of angle stops with these two plumber designed tools.

The larger forged steel socket "opens" to attach to an angle stop.
The smaller forged steel socket "opens" to attach to a 3/8" outlet supply nut.

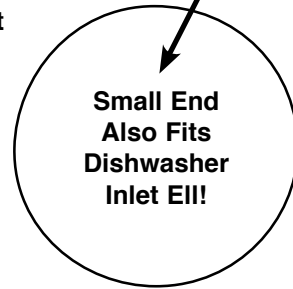
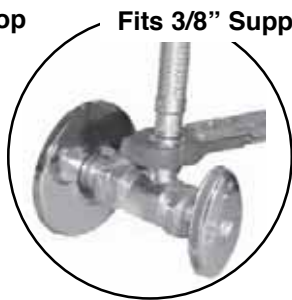

Don't forget to use with the ANGLE-ON WRENCH

- Fits 3/8" or 1/2" MPT compression outlet threads on angle stops.
- Help protect special finishes. Nickel plated steel and precision machined.

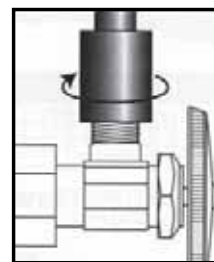
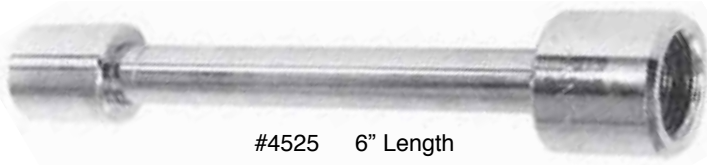

Remove outlet nut and screw on Angle-On

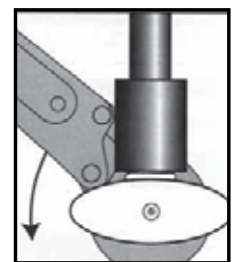

Angle-On acts as a lever for tightening compression angle stops.

PART NUMBER	DESCRIPTION
4524	Dual Kwik Tite Wrench ONLY
4525	Angle-On Wrench ONLY
4528	Dual Kwik Tite Wrench & Angle-On Wrench packaged together



Compression Sleeve Puller

Heavy duty - For 1/2" copper tubing

- Fully machined body and screw
- Designed by plumbing professionals
- Use 3/4" socket

All New Design!



shown in use



PART NUMBER
4661

Compression Sleeve Puller

Heavy duty - For 1/2" copper tubing

- Use 3/8" ratchet
- With 3/4" socket
- Removes compressed brass sleeves
- Precision machined
- Extremely durable
- Designed by plumbing professionals



PART NUMBER
4665

Compression Sleeve Puller Bullet Nose

Heavy duty - For 1/2" copper tubing

- Sleeve puller and handle sold separately
- Includes screw

New!



Re-designed bullet nose
will not pull off

PART NUMBER
4664



Big Yank - The Original

- Removes large and small handles
- Economical yet tough
- One piece forged drive bracket
- 4" bracket width
- 5" gripper fingers



PART NUMBER
4659

Big Yank Sr.™ - The Original

The only handle puller that grips faucet handles with 3 fingers!

- One piece forged drive bracket
- Notches in bracket keeps fingers from sliding apart
- Engineered for the professional
- 5" gripper fingers



PART NUMBER
4668

Compression Sleeve Puller

Economical for use with handle puller

- This unique tool, combines with a Big Yank handle puller (# 4659) removes installed 1/2" copper compression sleeves and nuts.
- Sleeve puller and handle sold separately.

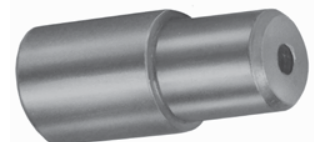

PART NUMBER
4655





No-Hub Torque Wrench 60 Inch Pounds

- Measures torque when turned in a clockwise direction & ratchets when turned counterclockwise
- Retractable reversing lever
- Chrome vanadium socket
- Tested to tighten up to 10,000 no-hub couplings*
- 5/16" socket

*Test results available

- Used with PASCO couplings in Section "D"

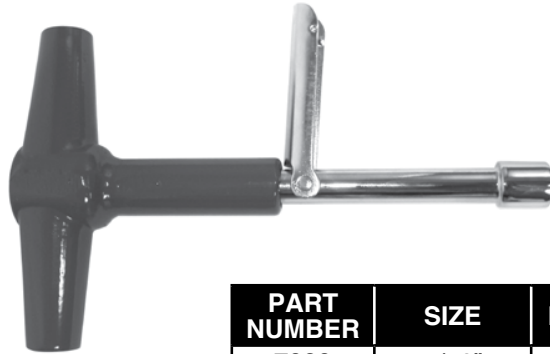

PART NUMBER	SIZE	LENGTH
7020	5/16"	6"

No-Hub Heavy Duty Torque Wrench 60 Inch Pounds

- Measures torque when turned in a clockwise direction & ratchets when turned counterclockwise
- When torque value has been reached, the tool will skip to prevent over tightening
- Chrome vanadium socket
- Locking collar
- 5/16" socket

- Used with PASCO couplings in Section "D"



New!

PART NUMBER	Size
2SH	5/16"

No-Hub Heavy Duty Torque Wrench 80 Inch Pounds

- Measures torque when turned in a clockwise direction & ratchets when turned counterclockwise
- When torque value has been reached, the tool will skip to prevent over tightening
- Chrome vanadium socket
- Locking collar
- 5/16" socket

- Used with PASCO Heavy Duty Couplings in Section "D"

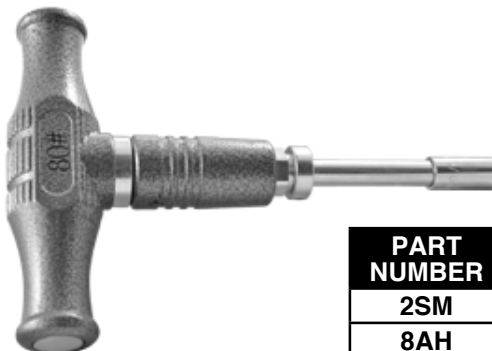

New!

PART NUMBER	Size
2SM	5/16"
8AH	3/8"



Quick Sweat

**Plumber
Designed!**

Patent Number 5,819,804

- Flexible 24" steel cables will slide through elbows and are interchangeable with the handle to fit different size copper.
- Durable polypropylene handle will fit 1/2" thru 2" cables.
- Long lasting elastomeric plug
- Eliminates "bread" and outperforms all the rest.

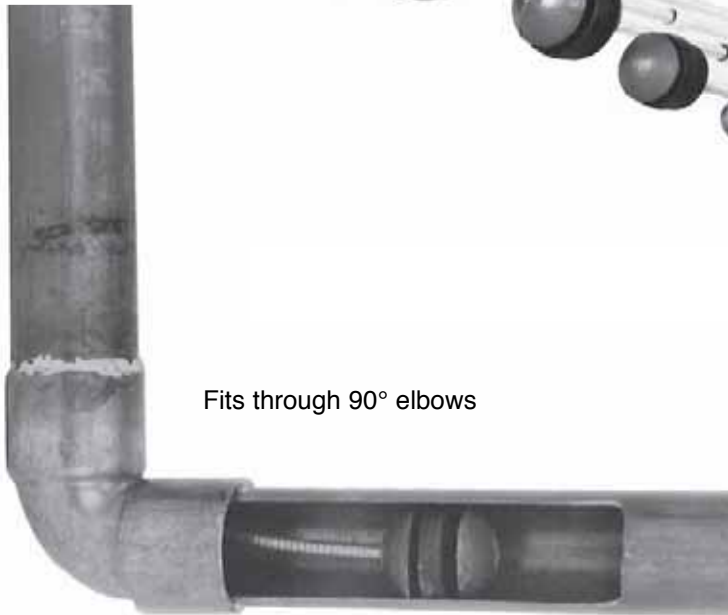

Fits through 90° elbows

PART NUMBER	SIZE
51500	Kit including: Handle & 1-each 1/2", 3/4", 1" cables
51050	1/2" Complete tool
51075	3/4" Complete tool
51100	1" Complete tool
51125	1-1/4" Complete tool
51150	1-1/2" Complete tool
51200	2" Complete tool
51040	Handle ONLY
51012	1/2" Cable ONLY
51034	3/4" Cable ONLY
51010	1" Cable ONLY
51114	1-1/4" Cable ONLY
51115	1-1/2" Cable ONLY
51120	2" Cable ONLY





6-in-1 Screwdriver

- 1/4" Hex - 5/16" Hex
- 12 Pack display when ordering a quantity of 12 or more.

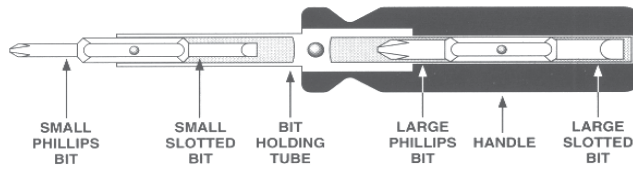

PART NUMBER	DESCRIPTION
4208	Screwdriver complete
4208-C	Carded screwdriver complete



PASCO "SET OF REDS"

Quick Set Pliers

- Easily fit 1-1/2" slip joint nuts
- Forged and chromed
- Vinyl grip handles



PART NUMBER	LENGTH
4063	10"

"Big Red" Tape Measure

- Unbreakable Cicolac case
- Power return
- Belt clip
- Yellow tape
- Now Showing Fractions on tape

New!



PART NUMBER	SIZE
3945	1" x 25'

Utility Knife

- Retractable



PART NUMBER	DESC.	# PER PACK
4323	Knife w/ 2 extra blades	1
4325	Extra Blades	5

6-in-1 Screwdriver

- 1/4" Hex - 5/16" Hex
- 12 Pack display when ordering a quantity of 12 or more.



PART NUMBER	DESCRIPTION
4208	Screwdriver complete
4208-C	Carded screwdriver complete



Journeyman Plastic Pipe Saws - The Original

- Cuts PVC, ABS, wood and drywall
- Unbreakable aluminum die cast handle
- Large, comfortable grip
- Flame hardened blade
- The best saw of its kind in the trade

Since 1973

Handle
Made in
U.S.A.

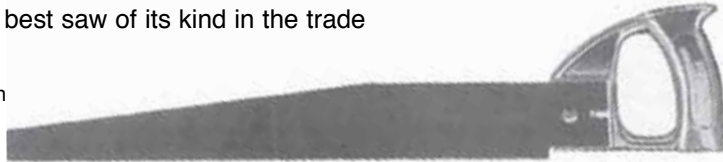

PART NUMBER	DESCRIPTION
4331	Complete "Mity Mite" Saw
4331-B	13" "Mity Mite" Blade
4333	Complete "Journeyman" Saw
4333-B	18" "Journeyman" Blade
4333-H	"Journeyman" Saw Handle

Tiny Tim Hacksaw - The Original

- Cuts steel & brass
- Vinyl grip handle
- Display carded
- Blades sold in reusable tube

Since 1946



PART NUMBER	DESCRIPTION
4290	Hacksaw w/Blade
4292	Extra Blades 10/package

Pull Plastic Pipe Saw

- Cuts plastic pipe
- Smooth, fast and accurate cutting
- Pull cutting action



PART NUMBER	DESCRIPTION
4338	Saw w/12" Blade
4338-B	12" Blade
4339	Saw w/8" Blade
4339-B	8" Blade

Hacksaw

- High quality plated steel saw with 1/2" x 6" or 1/2" x 12" tempered blade.
- Five times stronger than standard mini hacksaws



PART NUMBER	DESCRIPTION
4695	6" Heavy Duty Maximum Hacksaw
4695B	6" Blades Only
4696	12" Heavy Duty Maximum Hacksaw
4696B	12" Blades Only

Super Hacksaw

- Comfort front end grip
- Stores extra blades
- Cuts flush to surface



PART NUMBER	SIZE	BLADE SUPPLIED
4267	4"	12"

Hacksaw Blades

Bi-Metal Tough Cut Blades

PART NUMBER	TEETH PER INCH	BLADE LENGTH
4217	18	12"
4218	24	12"



“Pro-Cut” Plastic Pipe Cutters

- Superior quality, heavy duty
- Coated handles
- Built for constant use
- Stainless steel blade

Plumbers Favorite



*1” Plastic Pipe Cutter



*2” plastic pipe cutter

PART NUMBER	DESCRIPTION
4658	1” Pipe Cutter Complete
4658-B	Blade ONLY
4654	2” Pipe Cutter Complete
4654-B	Blade ONLY

PVC Pipe Cutter

- Cuts up to 1” PVC Pipe - all schedules!
- Cuts up to 1” CPVC



PART NUMBER	DESCRIPTION
4657	Complete
4657-B	Blade ONLY

Soft Pipe Cutter

- For cutting soft pipe and hose
- Heavy duty die cast
- Cuts up to 2” soft tubing
- Reversible Blade



The best cutter manufactured!

PART NUMBER	DESCRIPTION
4682	Complete
4682-B	Blade ONLY

Cable Saw

For fast cutting of PVC and irrigation pipe

- 24” Stainless steel cable
- Great for tight spots, need only 1/4” clearance
- Easily stored
- 30” Overall

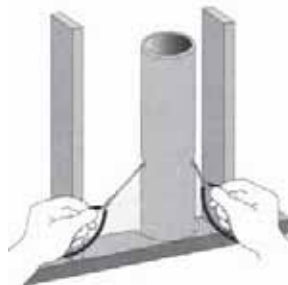

PART NUMBER	DESCRIPTION
4336-S	Strip pack of 10



Inside Plastic Pipe Cutter

- Fits 3/8” and larger drills



PART NUMBER	DESCRIPTION
3290	Pipe Cutter
3290-B	2 Blades per pack



Bi-Metal Tough Cut Reciprocating Saw Blades



PART NUMBER	LENGTH	TEETH PER INCH	USAGE RANK	CUTS THESE MATERIALS
3809	6"	10T	#8	Light, Non-ferrous metals, nail embedded woods, cast aluminum.
3810	6"	14T	#2	Heavy gauge metals, 1/8" conduit, pipe, tubing and galvanized pipe.
3811	6"	18T	#3	Metals to 1/8". Conduit, pipe, tubing and galvanized pipe.
3812	6"	24T	#5	Finer teeth for faster cutting of metal to 1/8", galvanized pipe.

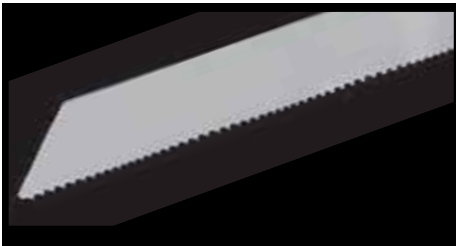

PART NUMBER	LENGTH	TEETH PER INCH	USAGE RANK	CUTS THESE MATERIALS
3820	9"	10/14T	#4	.050 Thick x 3/4" Wide super model for cast iron pipe. Teeth vary alternately from 10 to 14 per inch which reduces vibration and makes smoother cuts.



PART NUMBER	LENGTH	TEETH PER INCH	USAGE RANK	CUTS THESE MATERIALS
3813	6"	6T	#1	Fast cutting of all woods, nail embedded general roughing work.
3816	12"	6T	#7	Same as #3813 above



PART NUMBER	LENGTH	TEETH PER INCH	USAGE RANK	CUTS THESE MATERIALS
3814	8"	10T	#6	All woods, composition, plastics, 4" diameter pipe, cast iron, nail embedded woods, general metal cutting, fiberglass.



PART NUMBER	LENGTH	TEETH PER INCH	USAGE RANK	CUTS THESE MATERIALS
3808	6"	6T	#11	Plastic, lath, sheet rock, fiber board, particle board.



Reciprocating Saw Blade - Carbide Grit

- 3/4" Width
- Fits most reciprocating saws
- Flexible alloy steel
- Diamond hard tungsten carbide grit makes this blade last up to 20 times longer than conventional reciprocating blades



PART NUMBER	SIZE	SIZE
3835	6"	Medium
3845	8"	Medium

Carbide Hole Saw

- Cuts ceramic tile, stainless steel.
- Complete with D-Drive arbor and carbide drill.



PART NUMBER	DESCRIPTION
3912	1-1/4"
3913	1-3/8"
3915	1-3/4"
3916	Arbor w/carbide drill

Hex Key Tool Caddy

- Keys are #8650 chrome nickel alloy steel
- Close tolerance assures precise fit into hex socket
- Hardened and tempered for maximum durability



Made in U.S.A.

PART NUMBER	NO. OF KEYS	KEY SIZES
3040	9 Keys	5/64", 3/32", 7/64", 1/8", 9/64", 5/32", 3/16", 7/32", 1/4"
3041	8 Keys	.050", 1/16", 5/64", 3/32", 7/64", 1/8", 9/64", 5/32"

Hex Key Tool Caddy



PART NUMBER	KEY SIZES
4575	.28", .035", .050", 1/16", 5/64", 3/32", 7/64", 1/8", 9/64", 5/32", 3/16", 7/32", 1/4", 5/16", 3/8"





Copper, Brass & Stainless Steel Tubing Cutter

- Superior quality
- Enclosed feed mechanism
- Removable deburring tool located inside cutter frame
- Cuts up to 1-1/2"
- Spare blade in handle



*Replacement blade

PART NUMBER	DESCRIPTION
37610	Cuts up to 1-1/2"
37610-B	Replacement Blade

Mini Tubing Cutter

- Cuts up to 1" copper
- Grooved rollers

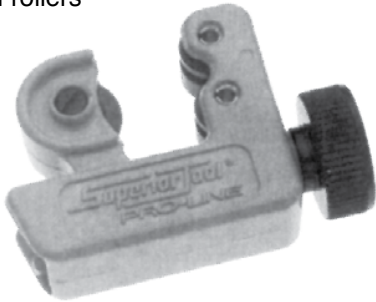

PART NUMBER	DESCRIPTION
35180	Cuts 1/8" - 1-1/8" Tubing
42835	Separate Cutter Wheel



Tubing and Pipe Cutter

- Cuts 1" IPS or 2" Copper
- Strong, yet lightweight
- Non-slip grip

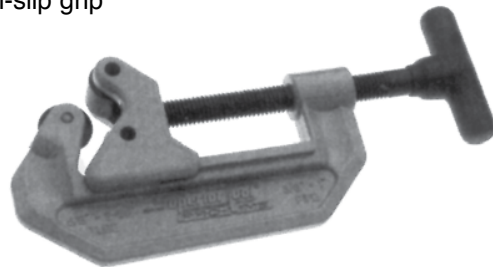

PART NUMBER	DESCRIPTION
36878	Cuts 5/8 - 2-1/8" IPS or 2" CWT
42348	Separate Cutter Wheel



Economy Tubing Cutter

- Grooved roller
- Retractable reamer

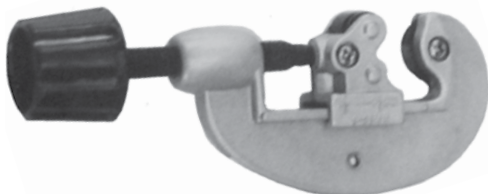

PART NUMBER	DESCRIPTION
4350	Cuts 1/8" to 1-1/8" Tubing
4349	Blades

Mini Tubing Cutter

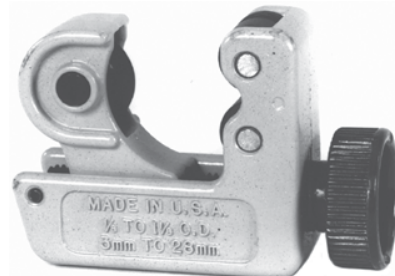

PART NUMBER	DESCRIPTION
4351	Cuts 1/8" to 7/8" Tubing



Swedging Tool

- For "M" Copper tubing



PART NUMBER	SIZE
4330	1/2" - 3/4" - 1"

Copper Sizing Tools

- Impact type to re-round copper tubing
- For "M" Copper tubing



PART NUMBER	SIZE
4343	1/2"
4344	3/4"
4345	1"

Copper Tube Flare Punches

- Soft copper tubing



PART NUMBER	SIZE
4367	3/4"
4368	1"

Economy Flaring Tool

- For O.D. sizes:
- 3/16", 1/4", 5/16", 3/8", 1/2", 5/8"
- Makes smooth flare



PART NUMBER
4360

Spark Lighters

- Round, Single, or Triple Flint
- Large hood traps more gas
- File rotates providing a fresh surface for the flint
- Flints good for 1,500 ignitions



4430



4437
Triple flint

PART NUMBER	DESCRIPTION	PKG.
4430	Lighter	10
4432	Extra Flints	5
4437	Shurlite Lighter	1
4438	Extra Flints	1





Chip and Oil Brush



PART NUMBER	SIZE
4647	1"
4649	2"

Natural Bristle Acid Brushes

- #1, #2, #4 Brushes sold 144 pieces per box
- #7 Brushes sold 36 pieces per box



PART NUMBER	SIZE	HANDLE MATERIAL
46501	#1	Metal
46512	#2	Metal
46524	#7	Metal
46537	#7	Wood

Wire Brushes



PART NUMBER	SIZE	HANDLE
4480	3 Rows of 19 Tufts	Long
4482	3 Rows of 19 Tufts	Short



Copper Deburring Tool - Reamer

- Die Cast
- Deburrs up to 1-1/4" copper or CPVC



PART NUMBER	SIZE
4356	1/2" - 1-1/4"

Copper Pipe Deburring Tools with Plastic Handles



Pen Style with Pocket Clip



*Sold with 4 extra blades stored in the handle

PART NUMBER	STYLE
5103	Pen Style
5104	*Tool w/ 4 Blades
5105	*5 Blades per Pack



Strap Wrenches

- Ideal for chrome pipe nipples
- Will not mar chrome, fittings & nipples



PART NUMBER	SIZE
4542	7"
4543	11"

Bibb Seat Tools

- For all faucet seats
- Cadmium plated
- Heat treated

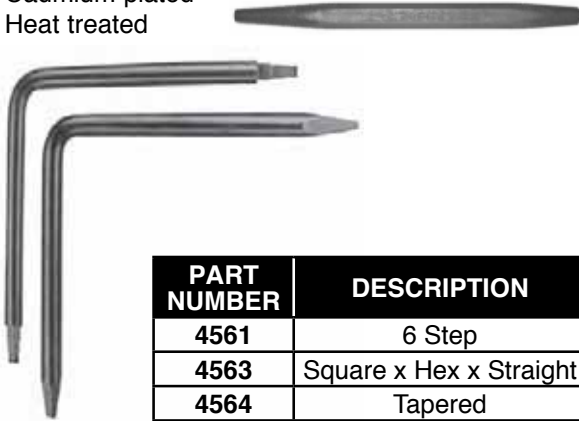

PART NUMBER	DESCRIPTION
4561	6 Step
4563	Square x Hex x Straight
4564	Tapered

Professional Faucet Reseater Kit

KIT INCLUDES:

- 4- Harden steel cutters for various size faucets
- 1- Guide cone
- 4- Faucet washers
- 1- Solid brass screw
- 1- Long shaft for tub & showers



PART NUMBER
4565

Bibb Seat Tool Set

SET INCLUDES:

- 1- 3/8" x 7/16" ratcheting box wrench
- 1- Small hex/large hex tapered bibb seat tool
- 1- Small square/large square no taper bibb seat tool



Packed in a sturdy, sealable plastic case.

PART NUMBER
4568

"The Best" Bibb Seat Tool

- Left hand threads - sure grip



PART NUMBER
4566



Sillcock Key

- Die Cast



PART NUMBER	SIZE
1700	5/16"

Heater Furnace Loglighter Keys

- Die Cast



PART NUMBER	SIZE	LENGTH
1705	5/16"	2-1/4"
1706	1/4"	10"
1707	5/16"	10"

Four Way Key

- Fits stopcocks, sillcocks and valves
- Sizes are 1/4" to 9/32" and 5/16" to 11/32"
- Die Cast
- Key chain loop



PART NUMBER
1701

Hex Screw and Nut Setter

- Use with 1/4" drill to drive hex sheet metal and anchor screws.
- Magnetic socket
- Heat treated
- 1/4" Drill shank



PART NUMBER	SIZE	BODY DIAMETER
1594	1/4"	7/16"
1595	5/16"	1/2"

Setting Tool

- Plated steel



PART NUMBER	SIZE
1552	3/8" or 1/2"



**Valve Stem Lube
Heat Proof Grease**

- Use on water or steam
- Apply to stems of faucets, packing, plungers, ball cocks, valves & washers
- Food grade



PART NUMBER
3155

Wire Stripper

- Adjusting stop on the gripping handles permits adjustment for wire size
- Vinyl grip handles



PART NUMBER
4107

Nut Driver



PART NUMBER	SIZE
4129	5/16"

**“Drop In” Half Barrel Type
Caulking Gun**

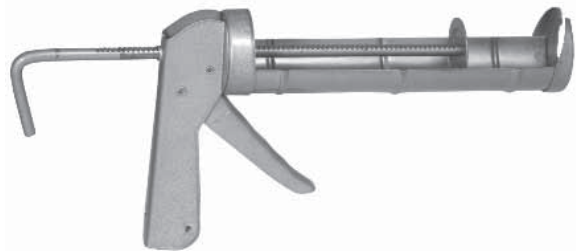

PART NUMBER
5100

Cellulose Sponges

- Excellent for drying and cleaning up
- For cleaning up tanks, lavatories, shower liners and leaking traps
- Yellow color



PART NUMBER	SIZES
5184	6" x 4-1/4" x 1-11/16"
5185	7-1/2" x 4-1/2" x 2-1/16"



Copper Fitting Brushes

- Economy
- Wire loop handle
- 2-Ply carbon steel bristles
- For bulk pricing add - BLK to part number



PART NUMBER	SIZE
5139	1/2"
5141	3/4"
5143	1"
5144	1-1/4"
5145	1-1/2"
5146	2"



- "A" Quality
- 2 Wire model
- High carbon crimped
- Steel bristles



PART NUMBER	SIZE
5113	3/8"
5114	1/2"
5116	3/4"
5118	1"
5119	1-1/4"
5120	1-1/2"
5121	2"

- "AA" Quality
- 4 Wire model
- Double construction from stainless steel wire



PART NUMBER	SIZE
5126	1/2"
5128	3/4"
5130	1"
5131	1-1/4"
5132	1-1/2"
5133	2"

Plumbers Open Mesh Sand Cloth

- Waterproof
- 180 Grit
- Aluminum oxide

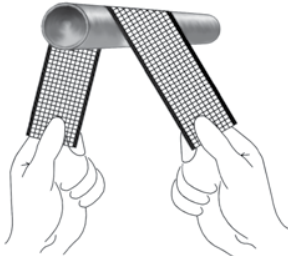

7.5 Yards
New More Convenient Size



PART NUMBER	SIZE
3108	7.5 Yards

4-in-1 Fitting Brush

- Tube cleaning and fitting brush
- High impact plastic & high carbon steel bristles
- Replaceable brushes
- 1/2" and 3/4" copper



PART NUMBER	DESCRIPTION
5150	Complete 4-in-1 Brush
5150-R	Replacement brush kit includes 2 ID & 2 OD brushes

Plumbers Sand Cloth

Specially formulated for use in preparing copper fittings and tubing for soldering 120 grit aluminum oxide.

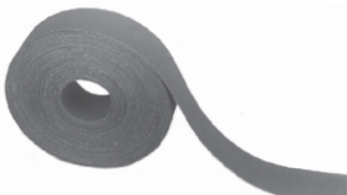

PART NUMBER	SIZE
3102	10 Yards

Copper Tube Brush

- The finest manufactured
- Cleans copper water tube end for soldering



Sizes indicated are nominal copper

PART NUMBER	SIZE
5153	1/2"
5155	3/4"
5157	1"





Nipple Boxes

- Holds CL thru 6" nipples
- Fold away handle
- Epoxy coated steel
- Light weight yet strong



PART NUMBER	SIZE	HOLDS
3080	1/2"	77
3081	3/4"	66
3082	1"	50
3083	1-1/4"	40
3084	1-1/2"	30
3085	2"	27



Fitting Tote Tray

- Excellent for copper fittings
- 18 Gauge
- 20" x 10" x 5"
- Fold away handle
- Epoxy coated steel



PART NUMBER	DESCRIPTION
3088	With 8 dividers
3088-LD	No dividers



1/2" and 3/4" Combo Nipple Box

- Holds both 1/2" and 3/4" nipples
- Holds (39) 1/2" CL thru 6"
- Holds (33) 3/4" CL thru 6"
- Fold away handle
- Epoxy coated steel



PART NUMBER
3091





Internal Nipple Wrench

- CAM Type
- Removes or inserts
- Heat treated
- Cadmium plated



PART NUMBER	NIPPLE SIZE
4531	1/2"
4532	3/4"
4533	1"

Internal Nipple Wrench

- Excellent for chrome work
- Precision machined and hardened
- Loosens and tightens
- Designed to grip internally
- Removes broken nipple threads from fittings



PART NUMBER	SIZES
4511	1/2" IPS Internal Wrench
4512	3/4" IPS Internal Wrench
4513	1" IPS Internal Wrench

Pipe Taps

- High carbon steel
- Tapered thread taps

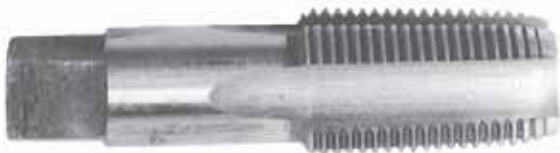

PART NUMBER	PIPE SIZE	NO. OF NPT	TAP DRILL SIZE
4812	1/8"	27	1/8"
4813	1/4"	18	7/16"
4814	3/8"	18	37/64"
4815	1/2"	14	45/64"
4816	3/4"	14	59/64"
4817	1"	11-1/2	1-5/32"
4818	1-1/4"	11-1/2	1-1/2"
4819	1-1/2"	11-1/2	1-47/64"
4820	2"	11-1/2	2-7/32"

Nipple and Screw Extractors

- Removes nipples, bolts and screws
- Left hand spiral tapered flute removes broken piece without thread damage



PART NUMBER	IND ID#	PIPE SIZE	DRILL SIZE	BOLT SCREW SIZE
4827	4	1/8"	1/4"	9/32" to 3/8"
4828	5	1/4"	19/64"	3/8" to 5/8"
4829	6	3/8"	13/32"	5/8" to 7/8"
4830	7	1/2"	17/32"	7/8" to 1-1/8"
4831	8	3/4"	13/16"	1-1/8" to 1-3/8"
4832	9	1"	1-1/16"	1-3/8" to 2"



Price Pfister® Special Shower Valve Socket Wrench

Fits both bonnet and packing nuts on Price-Pfister® Shower Valve Stems.

- Fits 31/32" stem bonnet nuts
- Fits 27/32" stem packing nuts
- 50% longer than regular shower valve wrenches
- Overall length allows socket to reach well into tile covered walls



PART NUMBER
5310

Pedestal Sink Wrench

- Offset design allows user to reach tailpiece and trap slip joint nuts
- Permits trap and drain line installation or removal with pedestal sink in place.



Patent Pending



PART NUMBER	SIZE
43914	1-1/4"
43915	1-1/2"

Shower Valve Socket Set - Professional Quality

- Heavy duty
- Each socket is 20% longer than the import
- High quality steel



PART NUMBER	DESCRIPTION
5300XH	Complete Set

Import Shower Valve Socket Set

- High quality steel



PART NUMBER	DESCRIPTION
5300	Complete Set



Commercial Sink Drain Tool

- Removes Lever & Twist Drains
- Fits 3" & 3-1/2" drains
- Constructed from 304 stainless steel
- Drain Sold Separately

New!

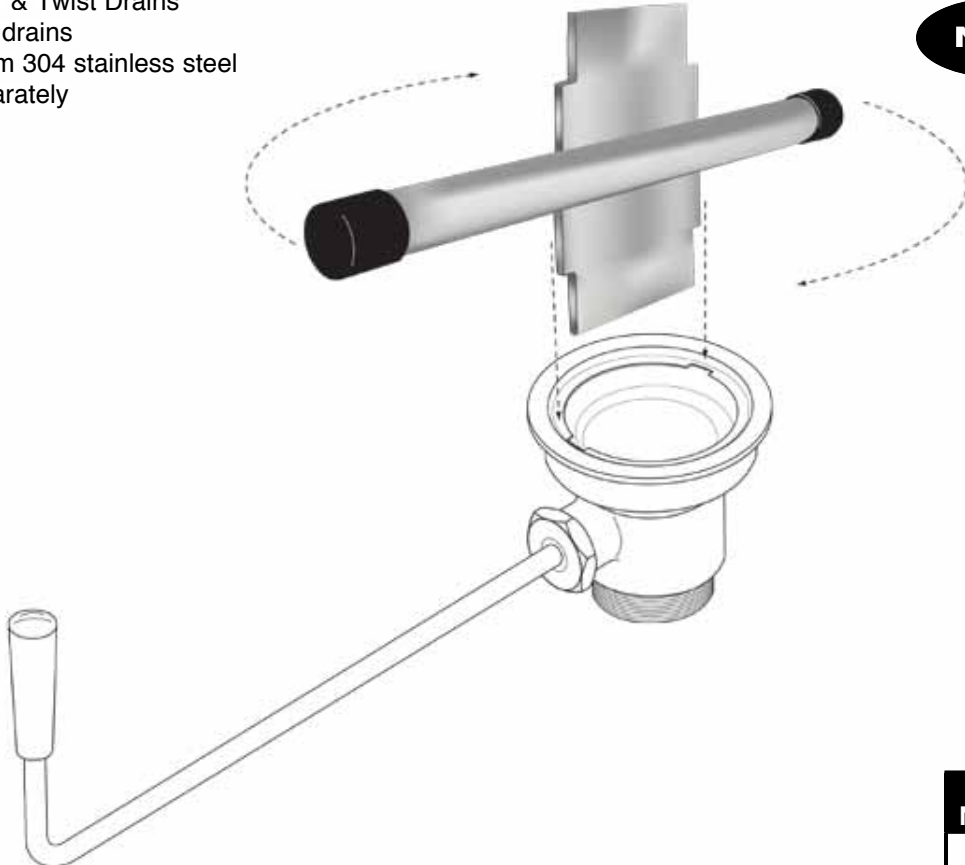

PART NUMBER
7093

Classic Drain Wrench

Tightens most fiberglass shower stall drain locknuts and die cast basket strainer locknuts.

- Fits 3-1/2" plastic locknuts
- Fits 3-3/8" die cast basket strainer locknuts
- Fits brass locknuts on brass shower stall drains
- Stamped steel
- 13" overall length
- Offset handle for close quarter work
- Cushion grip



PART NUMBER
7095



Basin Wrenches

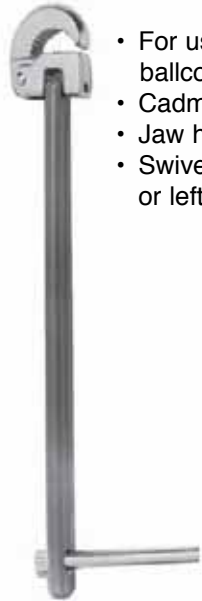

- For use on basin nuts, ballcocks & flush valves
- Cadmium plated
- Jaw has springs
- Swivel head operates right or left

Regular Basin Wrench

PART NUMBER	DESCRIPTION	SIZE	EXTENDS
4574	Regular Basin Wrench	11"	Does not Extend
*4573-L	Regular Basin Wrench	15"	Does not Extend
4573	Telescoping Basin Wrench	0"	9" to 16"
*4573-L	Telescoping Basin Wrench	0"	9" to 16"



- Extends from 9" to 16"
- Swivel jaw with spring
- Extra large jaw on
- 4573-L fits single lever faucet locknuts
- *Large jaw fits up to 2" locknuts

Telescoping Basin Wrench

Plumbers Combo Wrench

This all new wrench combines the features of 4 similar wrenches, including the Super Wrench. Designed for use on:

- Closet spuds
- Urinal spuds
- Kitchen basket strainers
- Urinal flush valves
- Compact 10" length



PART NUMBER
4556

Quick Set Drain Wrench

- Tightens or removes shower drains with internal locknut, (like our #7980)
- 10" overall length
- Plastic coated handle



PART NUMBER
7099



Closet Seat Nut Wrench

- Fits any length bolt
- Fits 99% of closet seat nuts
- Die cast



PART NUMBER
4557

PO Plug Wrench

- Removes PO plugs and tub drains



PART NUMBER
4555

4-in-1 Strainer Wrench

- Fits 3-3/8" strainer locknut
- 5-1/2" length
- Super tough Lexan plastic
- Slotted inserts that conveniently fit the standard slotted sink basket strainer locknuts

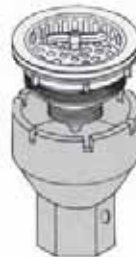

Tool ONLY
PART NUMBER
4948



Adjustable Spud Wrench

- 10" Length
- 1" to 3" Capacity
- For slip nuts, locknuts and strainer nuts



PART NUMBER
4571

Internal Spud Wrench

New Design!

- A must to install or remove urinal and closet spud, waste and overflows
- 4" capacity
- Cushioned grip
- High quality



PART NUMBER
4562

Garbage Disposal Wrench

- For releasing jammed garbage disposers
- 1/2" Steel
- 10" Length

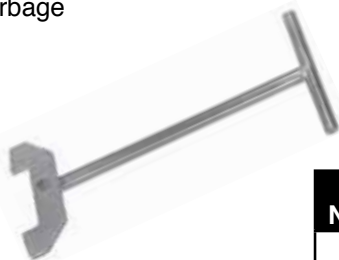

PART NUMBER
4943

Basket Strainer Wrench

- Zinc plated steel
- Handle slides



PART NUMBER
4949



New Design Heavy-Duty Water Heater Element Wrench

- Now use 1/2" ratchet
- Use pipe wrench on hex design



PART NUMBER
4946

Radiator Air Vent Wrench 3-Way



PART NUMBER
4947

Radiator Spud Wrench



PART NUMBER
4558

Sprinkler Nipple Extractor

- For plastic risers
- Not for Brass
- Irrigation



PART NUMBER
4498

Putty Knives

- High carbon cutlery steel
- Highly polished



PART NUMBER	BLADE
4116	Flexible
4117	Stiff



Professional Wear-A-Day Disposable Gloves

- Blue, powder-free latex
- Plumber grade
- Sold by the box
- 50 per box
- 15 mil latex



PART NUMBER
952
952XL

Disposable Gloves

- Powder-free latex
- Sold by the box
- 100 per box



PART NUMBER
950
950XL

Atlas® Fit 300 - Blue

The original palm coated glove!

- Natural rubber coating
- Breathable back
- Seamless knit liner
- Outstanding grip
- Ergonomic fit



New!

PART NUMBER
300M
300L
300XL

Atlas® Nitrile Tough 370 Gloves - Black/Grey

Long cuff & dark grey coating

- Grips
- Won't slip when wet
- Durable
- Resists solvent cement



New!

PART NUMBER
370M
370L
370XL

Atlas® Nitrile 380 - Blue/Black

Waffle Pattern Palm

- Lint free nylon liner
- Compressed air-infused foam nitrile coating
- Waffle pattern provides good grip in wet conditions
- Heavy duty



New!

PART NUMBER
380M
380L
380XL

Jersey Gloves

Cold weather favorite!

- Knit wrist in seal brown
- 9 oz. fabric
- 100% Cotton or Blend



New!

PART NUMBER	SIZE
403	Large
403M	Medium



Cotton Gloves

- 8 oz. cotton glove
- Knit wrist
- Large size only



PART NUMBER
641

Reversible Plastic Dot Gloves

- 8 oz. cotton glove
- Knit wrist
- Use twice
- Large size only

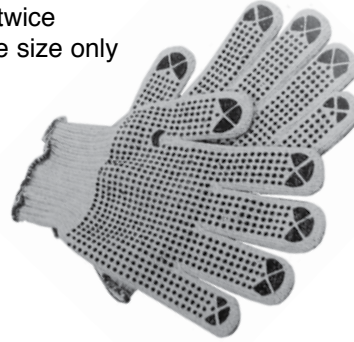

PART NUMBER
5500

Stallion Gloves

Best selling work glove in the industry

- Split leather palm glove
- Clute cut with 100% cotton fabric back
- Large size only



PART NUMBER
1290

Double Palm Gloves

- Wears especially well in uses such as handling a drain cleaning cable
- Large size only



PART NUMBER
5231-DP

Drain Snake Glove

Preferred by Plumbers

- PVC/NBR blend coating with PVC chips for non slip
- Chemical Resistant

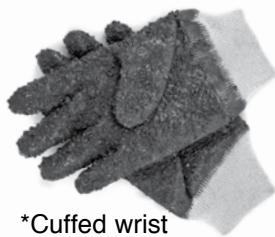

*Cuffed wrist



*Mid-forearm length

PART NUMBER	DESCRIPTION	PACK QTY
GL4100	Cuffed Wrist	1
GL4112	Mid-forearm length	1



Caulking Tools

- For lead & oakum



PART NUMBER	DESCRIPTION
4442	5/8" x 7" Inside caulker
4443	5/8" x 7" Outside caulker
4444	5/8" x 7" Straight caulker
4446	1-1/2" Curved board caulker
4447	5/8" x 12" Offset yarning iron

Plumbers Lead Pot



PART NUMBER	SIZE	VOLUME IN WEIGHT
4592	6"	30 lbs.

Lead Ladle



PART NUMBER	SIZE
4586	3-1/2"

Lead Melting Furnace

- Accommodates 6" to 8" lead pots
- Works off direct propane cylinder pressure
- Fits 3" cylinder spud
- Stand converts furnace to free standing unit
- 1/4" I.P.T. connections
- Hose not supplied



PART NUMBER	DESCRIPTION
4597	furnace without stand
4599	stand with valve

Lead Joint Runners

- Non-asbestos



PART NUMBER	RUNNER SIZE	FOR SOIL PIPE SIZE
4576	#1	2" to 4"



“Grab All” Retrieving Tool

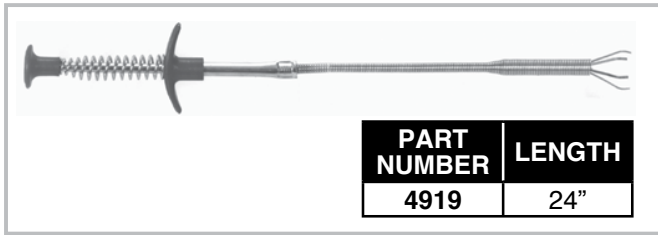

Magnetic Retrieving Tool



Inspection Mirror

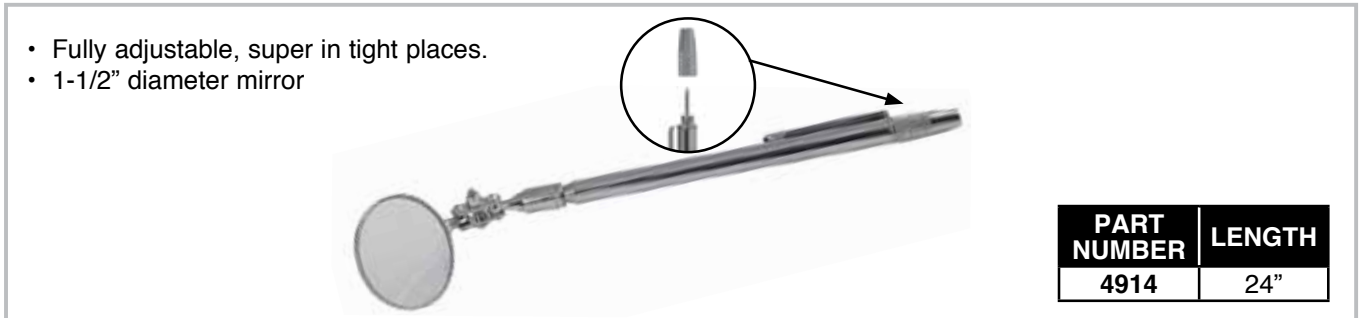

Protective Knee Pads

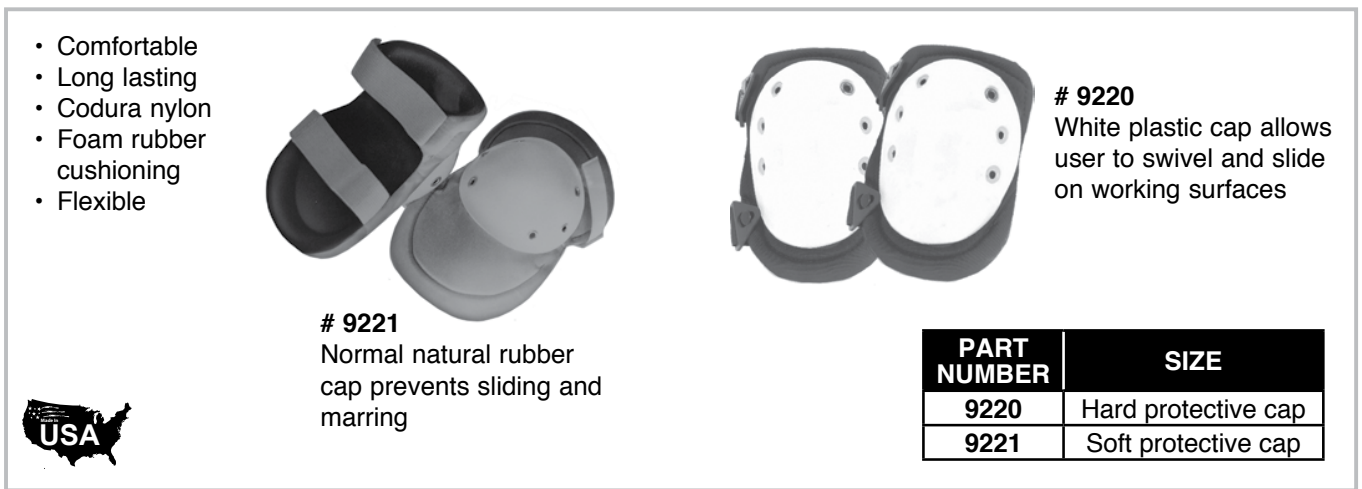

Disposable Shoe Covers



Torpedo Level





Toilet Boot - Protects Bathroom Floors

An absolute must for hassle free toilet moving or removal. Protect all bathroom floors from bowl wax or scratching.

Packaged for hang up display.

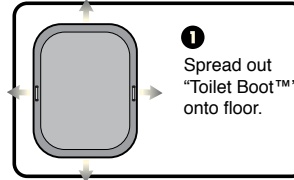

1 Spread out "Toilet Boot™" onto floor.

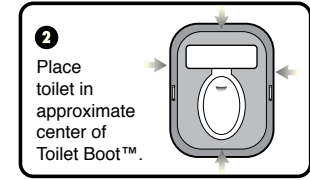

2 Place toilet in approximate center of Toilet Boot™.

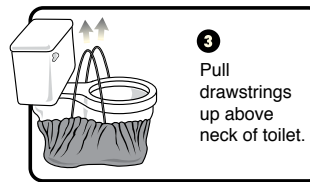

3 Pull drawstrings up above neck of toilet.

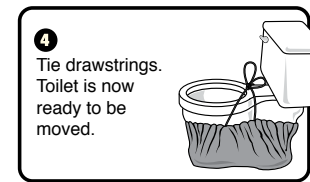

4 Tie drawstrings. Toilet is now ready to be moved.

PART NUMBER	CASE QTY
1080	12

Hand Pumps

- Use to drain or transfer water
- Large volume of water drawn with each pull of the handle



6 foot hose

Mini pump ideal for draining traps or curved pipe

PART NUMBER	HOSE LENGTH
136PF-6	6 ft.
12-A	3 ft.

Eureka Cleanout Plug Wrench

- This unique tool fits either slotted or square countersunk cleanout plugs
- Strong, malleable iron
- Fits slotted or square
- As Seen On TV - "This Old House"

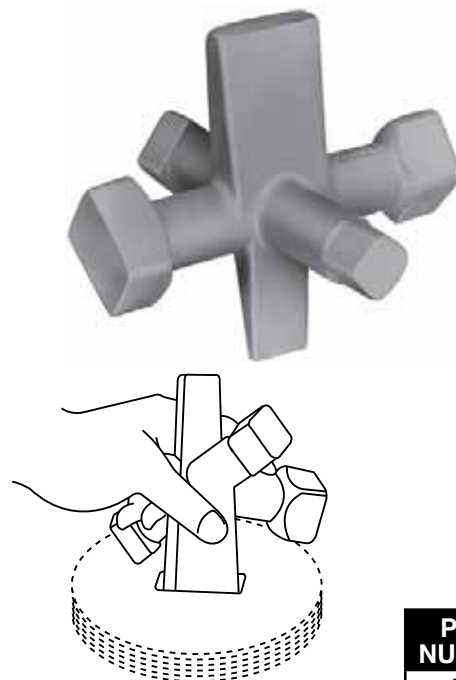

PART NUMBER
4567



Meter Key Socket Head

Make any length meter key using 1/2" IPS threaded pipe and this socket



PART NUMBER
4059

Water Meter Box Key

- Brass
- Fits most locks



PART NUMBER
4074

Water Meter Key

All new lightweight design!
This key is designed for valves that are hard to turn

- Minimum order of 5 keys required
- Heavy duty



PART NUMBER	SHAFT DIAMETER	LENGTH	HANDLE LENGTH
4061	5/8"	60"	14"
4089	3/4"	40"	14"

Simply The Best Plumber's Air Pump

- Made of virtually unbreakable polyethylene
- 1-1/4" one piece barrel permits a large volume of air
- 48" Non-kinking reinforced hose
- Quick connect thumb valve
- Large easy one-piece grip handle
- 2" 0-160PSI gauge
- Easy to read RED pressure range arrow
- Hose attached to swivel at base to prevent breaking
- Foot pad is an integral part of pump - won't pull off



PART NUMBER
1424



Pro-Strap®

U.S. Patent 5,603,591

The professional tie-down strap designed by a contractor for contractors! Allows you to fasten lightweight pipe, ladders, poles & other job materials quickly & securely to your construction vehicle.

- Strong, durable, reliable. Made of black woven polypropylene webbing and industrial strength Velcro.
- Secures material in seconds in all weather conditions. No more wire twists, rubber-hooked tie downs or hard-to-untie knots.
- UV Resistant, not affected by the sun, heat or cold.

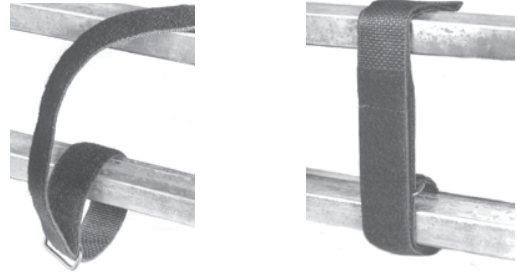

PART NUMBER	LENGTH
49431	43"
49721	72"



Tie Down Straps

- Elastic rubber



PART NUMBER	LENGTH	LENGTH STRETCHED
4903*	15"	20"
4905*	21"	25"
4907*	31"	36"
4909*	41"	46"

* INDICATE
-10 for 10 pack
-50 for 50 pack

Nylon Seine Twine

- For plumb line, seine line, chalk line, mason line



PART NUMBER	SIZE	TEST	LENGTH
4115	#18	179 lb.	275 ft.



Binder Twine

- 2,000 Ft.
- Sisal



PART NUMBER
4043

Truck Rope

- Polypropylene - Black-Orange



PART NUMBER	O.D. SIZE	LENGTH
4111	3/8"	50 ft.
4112	3/8"	600 ft.



Master Plumbers Force Cup

- Heavy duty
- Ribbed cup for strength
- Provides big "blast" for all stoppages
- High quality rubber
- 19" handle



PART NUMBER
4636

Heavy Duty Closet Bowl Force Cup

- Extra large for best pressure with positive seal
- Designed for all types of toilets
- High quality black rubber
- 19" handle



PART NUMBER
4637

Economy Force Cup

- High quality red rubber
- Available in 5" or 6" diameter
- 19" handle



PART NUMBER	SIZE
4640	5"
4641	6"



Water Heater Grounding Items

- Bare bronze clamp - steel screws
- Fits 1/2" - 1" pipe
- 2 strand ground wire max
- 10 per bag



*Grounding Adapter



*Screw-On Wire Connectors

- Industry standard
- Reinforced phenolic
- 600 V

- 6 gauge
- 250 foot spool

New!

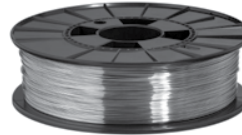

*Bare Copper Grounding Wire

PART NUMBER	DESCRIPTION
8330	Bare Copper Grounding Wire
5075	Grounding Adapter
5070	Screw-on's: Orange = Small Connects wire sizes #22 - #14
5074	Screw-on's: Yellow = Medium Connects wire sizes #18 - #10

Water Heater Grounding Kits

- Two Bare bronze clamp - steel screws
- Fits 1/2" - 1" pipe



*1050



*1052

New!

PART NUMBER	DESCRIPTION
1050	Water Heater Grounding Kit 12"
1052	Water Heater Grounding Kit 24"

"Romex" Connector

- For garbage disposal pigtails
- Zinc die cast
 - Dry location use



New!

10 per bag

PART NUMBER
5080

Thermostat Wire

- Solid copper conductors with PVC insulation, conductors twisted
- Color coded
- Bagged



PART NUMBER	LENGTH	WIRE TYPE
8320	25'	18/2
8321	50'	

**Adapters
U-Ground 3 Outlet**

- 15 A rating
- 14/3 cord
- All u-ground connection
- 24" length



PART NUMBER
8291

Twist & Lock to U-Ground

- Male twist and lock to female u-ground
- 15 A plug, 20 A connection
- 12/3 ST cord
- 12" length



PART NUMBER
8302



Heavy Duty Extension Cords

- Straight caps
- Round cord



PART NUMBER	LENGTH	RATING	CORD TYPE
8024	25'	13-A	16/3 SJT
8025	50'	13-A	
8028	50'	15-A	

Trouble Lights

- Metal bulb guard
- *Arctic cord- Blue



PART NUMBER	LENGTH	RATING	CORD TYPE
8072*	25'	13 A	16/3 SKEW-A BLUE
8073*	50'		
8165	25'	13 A	16/3 SJT
8166	50'		

Disposer, Timer & Furnace Cords

ANGLE CAPS

- Wire Nuts
- Romex Connector
- Ends stripped 5/8"
- Pigtail



PART NUMBER	LENGTH	RATING	CORD TYPE
8121	3'	13-A	16/3 SPT
8122	4'		
8123	5'		
8124	6'		
8125	8'		

STRAIGHT CAPS

- Wire Nuts
- Romex Connector
- Ends stripped 5/8"
- Pigtail



PART NUMBER	LENGTH	RATING	CORD TYPE
8130	3'	13-A	16/3 SPT
8131	4'		
8132	5'		
8133	6'		
8134	8'		