

## 62M Mop Service Basin – 24" x 24" x 8 1/4"





Engineered and built to provide years of service, Mustee's 62M Mop Service Basin includes all the features most wanted by maintenance and housekeeping professionals. Mustee mop basins are also being installed in homes for a wide variety of cleaning tasks. A complete range of accessories are also available to customize your Model 62M to best meet specific application needs.



### Features:

- High impact resistant, one piece molded DURASTONE® structural fiberglass
- Generous 8 1/4" high side walls to contain splashes
- Removable strainer
- Integral molded-in drain with seal for installing to 3" ABS, PVC. (Sch. 80) or cast iron
- Available drain seals for connecting 2" pipe or 3" no-hub soil pipe
- Convenient anchor brackets for securing to wall
- A complete range of mop basin accessories is available to customize your application, see reverse side for details

### Code Listed:

- IAPMO® Listed 
- Warnock Hersey Listed   
CSA Test Standards: Mop Basin – #B45.0 
- American National Standards Institute (ANSI) — Specification Z 124.6 
- American Society of Testing and Material (ASTM) — D 635, E 84 and E 162
- CAN/ULC S102-07 Burn and Smoke Test

### Specifications

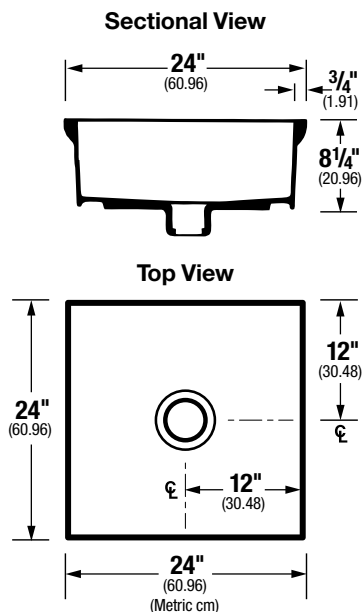

Model	Color	I.P.S.	Size
62M	White	3	24" wide x 24" deep

### Sub-Floor Rough-in — for slab leave 2 1/4" min. depth

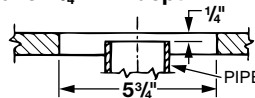

### Anchoring Brackets Provided — for securing mop basin to wall

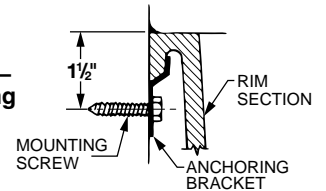

**General:** Furnish and install as shown on plans, Mop Service Basin model 62M, as manufactured by E.L. Mustee & Sons, Inc. Unit to be one-piece, molded fiberglass made with matched metal molds using extreme heat and pressure. Height shall be 8 1/4" with not less than 3/4" wide shoulder. Size 24" x 24". Drain shall be integrally molded, complete with drain seal for installation of 3" ABS, PVC (Sch. #80) and iron pipe. Removable stainless steel strainer. Performance tested to meet or exceed ANSI Specifications Z 124.6. Weight 45 lbs. Install in compliance with local codes.

## MUSTEE Mop Basins are ideal for...



Washing Muddy Toys



Pet Washing



Garden Tool Cleanup

To reorder, specify ADV-357

Notice: Our continuous commitment to product improvement may result in changes to product specifications without notice. Patented and patents pending. ADI/5-10/NM. Made and Printed in U.S.A.

## Mop Service Basin Accessories (Order Separately)

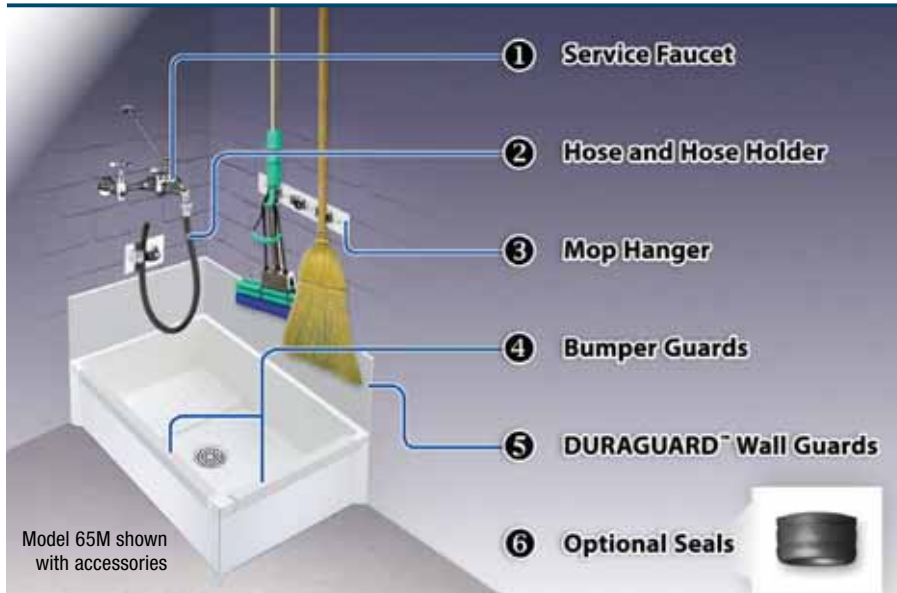

Model 65M shown with accessories

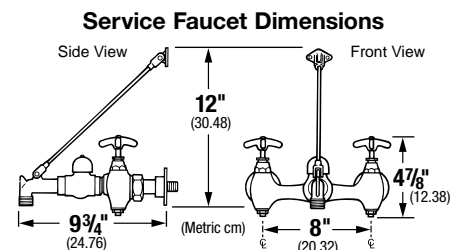

### 1 Service Faucet

#### Model 63.600A

Chrome plated brass service sink faucet, 1/2" pipe eccentric inlets on 8" centers. Vacuum breaker integral stops, chrome plated (H&C) handles, 3/4" hose end spout with pail hook, top reinforcing bar and mounting bracket. Shall meet ANSI Specifications A112.1.1, Section 2.9 (ANSI) and A112.18.1M, CSA Listed. (SF)



### 2 Hose and Hose Holder

#### Model 65.700

Heavy duty 5/8" dia. reinforced 31" rubber hose with brass couplings on one end. Spring loaded, molded rubber hose holder mounts on stainless steel wall plate.



### 3 Mop Hanger

#### Model 65.600

Three spring-loaded rubber holders mounted to a 3" x 24" stainless steel wall plate.



### 4 Bumper Guards Available in high impact resistant molded vinyl (3 versions) or stainless steel (2 versions).

#### Model

#### High Impact-Resistant Vinyl

**62.401** 21 1/2" Long, Fits Model 62M

**63.401** 20 3/4" Long, Fits Model 63M & 65M

**65.403** 32 3/4" Long, Fits Model 65M

#### Model

#### Stainless Steel

**63.403** 20 3/4" Long, Fits Model 63M & 65M

**65.404** 32 3/4" Long, Fits Model 65M

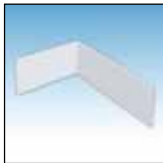

### 5 DURAGUARD™ Wall Guards

#### Model

**67.2424** Two panels & bracket for 24" x 24" corner

**67.24C** One panel & corner bracket

#### Model

**67.24C** One 24" panel & corner bracket

**67.36C** One 36" panel & corner bracket

Protects wall surfaces from splashing and damage from impacts, 12" height, 20 gauge #304 stainless steel.



### 6 Optional Seals For installations with the following pipe connections:

#### Model

**65.308** For 2" PVC, ABS and iron

**65.309** For 3" PVC, ABS and iron, (Included w/mop basin)

#### Model

**65.311** For 3" soil pipe (No-Hub)