

June 2010

No. OCH468
REVISED EDITION-A



TECHNICAL & SERVICE MANUAL

[Model name]
<Outdoor unit>

MXZ-8B48NA

<Branch box>

PAC-AKA51BC

PAC-AKA31BC

(Indispensable optional parts
for MXZ-8B48NA)

[Service Ref.]

MXZ-8B48NA

PAC-AKA51BC
PAC-AKA31BC

NOTE:

- The cooling capacity table (4-1.) has been modified.
- This service manual describes technical data of outdoor unit and branch box. As for indoor units, refer to its service manual.
- RoHS compliant products have <G> mark on the spec name plate.

- Please void OCH468.

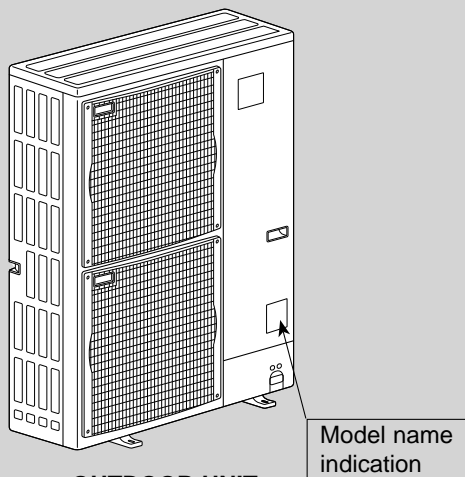

OUTDOOR UNIT

BRANCH BOX

CONTENTS

1. SAFETY PRECAUTION.....	2
2. OVERVIEW OF UNITS.....	5
3. SPECIFICATIONS.....	9
4. DATA.....	11
5. OUTLINES AND DIMENSIONS.....	34
6. WIRING DIAGRAM.....	36
7. NECESSARY CONDITIONS FOR SYSTEM CONSTRUCTION....	38
8. TROUBLESHOOTING.....	39
9. PRECAUTIONS AGAINST REFRIGERANT LEAKAGE.....	79
10. DISASSEMBLY PROCEDURE.....	81

PARTS CATALOG (OCB468)

1

SAFETY PRECAUTION

1-1. ALWAYS OBSERVE FOR SAFETY

Before obtaining access to terminal, all supply circuit must be disconnected.

1-2. CAUTIONS RELATED TO NEW REFRIGERANT

Caution for units utilizing refrigerant R410A

Use new refrigerant pipes.

Make sure that the inside and outside of refrigerant piping is clean and it has no contaminants such as sulfur, oxides, dirt, shaving particles, etc, which are hazard to refrigerant cycle. In addition, use pipes with specified thickness.

Contamination inside refrigerant piping can cause deterioration of refrigerant oil etc.

Store the piping to be used indoors during installation, and both ends of the piping sealed until just before brazing. (Leave elbow joints, etc. in their packaging.)

If dirt, dust or moisture enters into refrigerant cycle, that can cause deterioration of refrigerant oil or malfunction of compressor.

The refrigerant oil applied to flare and flange connections must be ester oil, ether oil or alkylbenzene oil in a small amount.

If large amount of mineral oil enters, that can cause deterioration of refrigerant oil etc.

Charge refrigerant from liquid phase of gas cylinder.

If the refrigerant is charged from gas phase, composition change may occur in refrigerant and the efficiency will be lowered.

Do not use refrigerant other than R410A.

If other refrigerant (R22 etc.) is used, chlorine in refrigerant can cause deterioration of refrigerant oil etc.

Use a vacuum pump with a reverse flow check valve.

Vacuum pump oil may flow back into refrigerant cycle and that can cause deterioration of refrigerant oil etc.

Use the following tools specifically designed for use with R410A refrigerant.

The following tools are necessary to use R410A refrigerant.

Tools for R410A	
Gauge manifold	Flare tool
Charge hose	Size adjustment gauge
Gas leak detector	Vacuum pump adaptor
Torque wrench	Electronic refrigerant charging scale

Handle tools with care.

If dirt, dust or moisture enters into refrigerant cycle, that can cause deterioration of refrigerant oil or malfunction of compressor.

Do not use a charging cylinder.

If a charging cylinder is used, the composition of refrigerant will change and the efficiency will be lowered.

Ventilate the room if refrigerant leaks during operation. If refrigerant comes into contact with a flame, poisonous gases will be released.

[1] Cautions for service

- (1) Perform service after recovering the refrigerant left in unit completely.
- (2) Do not release refrigerant in the air.
- (3) After completing service, charge the cycle with specified amount of refrigerant.
- (4) When performing service, install a filter drier simultaneously.
Be sure to use a filter drier for new refrigerant.

[2] Additional refrigerant charge

When charging directly from cylinder

- Check that cylinder for R410A on the market is syphon type.
- Charging should be performed with the cylinder of syphon stood vertically. (Refrigerant is charged from liquid phase.)

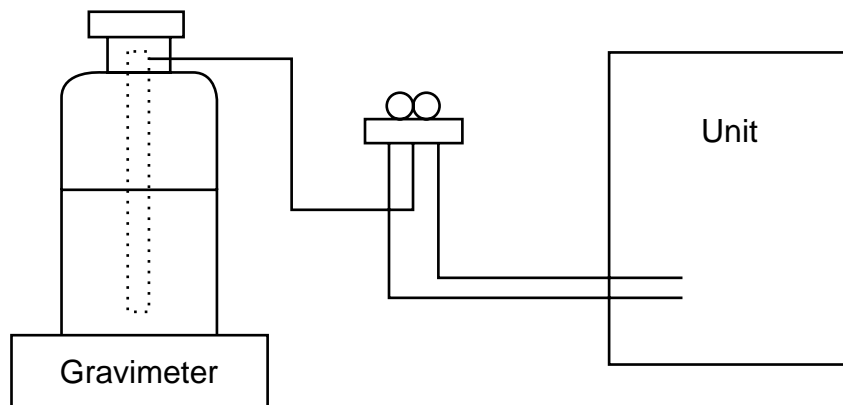

[3] Service tools

- (1) Use the below service tools as exclusive tools for R410A refrigerant.

No.	Tool name	Specifications
①	Gauge manifold	·Only for R410A
		·Use the existing fitting specifications. (UNF1/2)
		·Use high-tension side pressure of 5.3MPa-G or over.
②	Charge hose	·Only for R410A
		·Use pressure performance of 5.09MPa-G or over.
③	Electronic scale	—
④	Gas leak detector	·Use the detector for R134a, R407C or R410A.
⑤	Adaptor for reverse flow check	·Attach on vacuum pump.
⑥	Refrigerant charge base	—
⑦	Refrigerant cylinder	·Only for R410A ·Top of cylinder (Pink)
		·Cylinder with syphon
⑧	Refrigerant recovery equipment	—

1-3. Cautions for refrigerant piping work

New refrigerant R410A is adopted for replacement inverter series. Although the refrigerant piping work for R410A is same as for R22, exclusive tools are necessary so as not to mix with different kind of refrigerant. Furthermore as the working pressure of R410A is 1.6 times higher than that of R22, their sizes of flared sections and flare nuts are different.

① Thickness of pipes

Because the working pressure of R410A is higher compared to R22, be sure to use refrigerant piping with thickness shown below. (Never use pipes of 0.7 mm [7/256 inch] or below.)

Diagram below: Piping diameter and thickness

Nominal dimensions[inch]	Outside diameter (mm)	Thickness (mm) [inch]	
		R410A	R22
1/4	6.35	0.8 [1/32]	0.8 [1/32]
3/8	9.52	0.8 [1/32]	0.8 [1/32]
1/2	12.70	0.8 [1/32]	0.8 [1/32]
5/8	15.88	1.0 [5/128]	1.0 [5/128]
3/4	19.05	—	1.0 [5/128]

② Dimensions of flare cutting and flare nut

The component molecules in HFC refrigerant are smaller compared to conventional refrigerants. In addition to that, R410A is a refrigerant, which has higher risk of leakage because its working pressure is higher than that of other refrigerants. Therefore, to enhance airtightness and intensity, flare cutting dimension of copper pipe for R410A has been specified separately from the dimensions for other refrigerants as shown below. The dimension B of flare nut for R410A also has partly been changed to increase intensity as shown below. Set copper pipe correctly referring to copper pipe flaring dimensions for R410A below. For 1/2 and 5/8 inch, the dimension B changes. Use torque wrench corresponding to each dimension.

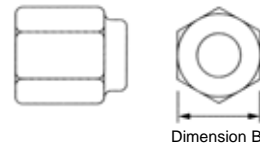
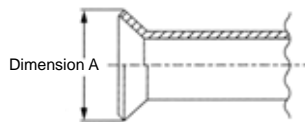

Nominal dimensions[inch]	Outside diameter	Dimension A (mm) [inch]	
		R410A	R22
1/4	6.35	9.1 [11/32-23/64]	9.0
3/8	9.52	13.2 [1/2-33/64]	13.0
1/2	12.70	16.6 [41/64-21/32]	16.2
5/8	15.88	19.7 [49/64-25/32]	19.4
3/4	19.05	—	23.3

Nominal dimensions[inch]	Outside diameter[inch]	Dimension B (mm) [inch]	
		R410A	R22
1/4	6.35	17.0 [43/64]	17.0
3/8	9.52	22.0 [7/8]	22.0
1/2	12.70	26.0 [1-3/64]	24.0
5/8	15.88	29.0 [1-9/64]	27.0
3/4	19.05	—	36.0

③ Tools for R410A (The following table shows whether conventional tools can be used or not.)

Tools and materials	Use	R410A tools	Can R22 tools be used?	Can R407C tools be used?
Gauge manifold	Air purge, refrigerant charge and operation check	Tool exclusive for R410A	×	×
Charge hose		Tool exclusive for R410A	×	×
Gas leak detector	Gas leak check	Tool for HFC refrigerant	×	○
Refrigerant recovery equipment	Refrigerant recovery	Tool exclusive for R410A	×	×
Refrigerant cylinder	Refrigerant charge	Tool exclusive for R410A	×	×
Applied oil	Apply to flared section	Ester oil, ether oil and alkylbenzene oil (minimum amount)	×	Ester oil, ether oil: ○ Alkylbenzene oil: minimum amount
Safety charger	Prevent compressor malfunction when charging refrigerant by spraying liquid refrigerant	Tool exclusive for R410A	×	×
Charge valve	Prevent gas from blowing out when detaching charge hose	Tool exclusive for R410A	×	×
Vacuum pump	Vacuum drying and air purge	Tools for other refrigerants can be used if equipped with adopter for reverse flow check	△ (Usable if equipped with adopter for reverse flow)	△ (Usable if equipped with adopter for reverse flow)
Flare tool	Flaring work of piping	Tools for other refrigerants can be used by adjusting flaring dimension	△ (Usable by adjusting flaring dimension)	△ (Usable by adjusting flaring dimension)
Bender	Bend the pipes	Tools for other refrigerants can be used	○	○
Pipe cutter	Cut the pipes	Tools for other refrigerants can be used	○	○
Welder and nitrogen gas cylinder	Weld the pipes	Tools for other refrigerants can be used	○	○
Refrigerant charging scale	Refrigerant charge	Tools for other refrigerants can be used	○	○
Vacuum gauge or thermistor vacuum gauge and vacuum valve	Check the degree of vacuum. (Vacuum valve prevents back flow of oil and refrigerant to thermistor vacuum gauge)	Tools for other refrigerants can be used	○	○
Charging cylinder	Refrigerant charge	Tool exclusive for R410A	×	—

× : Prepare a new tool. (Use the new tool as the tool exclusive for R410A.)

△ : Tools for other refrigerants can be used under certain conditions.

○ : Tools for other refrigerants can be used.

2

OVERVIEW OF UNITS

2-1. CONSTRUCTION OF SYSTEM

Outdoor unit		MXZ-8B48NA	
		Rated capacity (kBTU/h) (Cooling/Heating)	48/54
		MAX. capacity (kBTU/h) (Cooling/Heating)	54/60
		6HP	
		R410A	
Indoor unit that can be connected	Capacity	Type 06 ~ Type 24	
	Number of units	2 ~ 8 units	
	Total system wide capacity	22.2 ~ 130 % of outdoor unit MAX. Cooling capacity (12 kBTU/h ~ 70.2kBTU/h)	
Branch box that can be connected	Number of units	1 ~ 2 units	



Connectable indoor unit lineup (Heat pump inverter type)			Capacity class [kBTU/h]					
Model type	Model name	Capacity class [kBTU/h]						
		06	09	12	15	18(17)	24	
Wall mounted	Deluxe	MSZ-FE09/12, MSZ-FD09/12		●	●			
	Standard	MSZ-GE06/09/12/15/18/24	●	●	●	●	●	●
		MSZ-GA24						●
		MSZ-A09/12/15/17/24		●	●	●	●	●
Ceiling concealed	Low static pressure	SEZ-KD09/12/15/18		●	●	●	●	
	Middle static pressure	PEAD-A24AA						●
4-way ceiling cassette	Standard	PLA-A12/18/24BA			●		●	●
Floor standing		MFZ-KA09/12/18NA		●	●		●	

<NOTE> The lineup of a connectable indoor unit depends on a district/areas/country.



Branch box	PAC-AKA51BC	PAC-AKA31BC
Number of branches (Indoor unit that can be connected)	5 branches (MAX. 5 units)	3 branches (MAX. 3 units)

* Max. 2 branch boxes can be connected to 1 outdoor unit.



2-branch pipe (joint) : Optional parts							
In case of using 1- branch box	No need						
In case of using 2- branch boxes	<table border="1" style="width: 100%;"> <thead> <tr> <th>Model name</th> <th>Connection method</th> </tr> </thead> <tbody> <tr> <td>MSDD-50AR-E</td> <td style="text-align: center;">flare</td> </tr> <tr> <td>MSDD-50BR-E</td> <td style="text-align: center;">brazing</td> </tr> </tbody> </table>	Model name	Connection method	MSDD-50AR-E	flare	MSDD-50BR-E	brazing
	Model name	Connection method					
	MSDD-50AR-E	flare					
MSDD-50BR-E	brazing						
* According to the connection method, you can choose the favorite one.							



Option	Optional accessories of indoor units and outdoor units are available.
--------	---

2-2. SYSTEM OUTLINE

The additional connection of the Branch Box together with employment of the compact trunk-looking outdoor unit can successfully realize a long distance piping for big houses. Equipped with a microcomputer, the Branch Box can translate the transmission signal of indoor units to achieve the optimum control.

2-2-1. System example

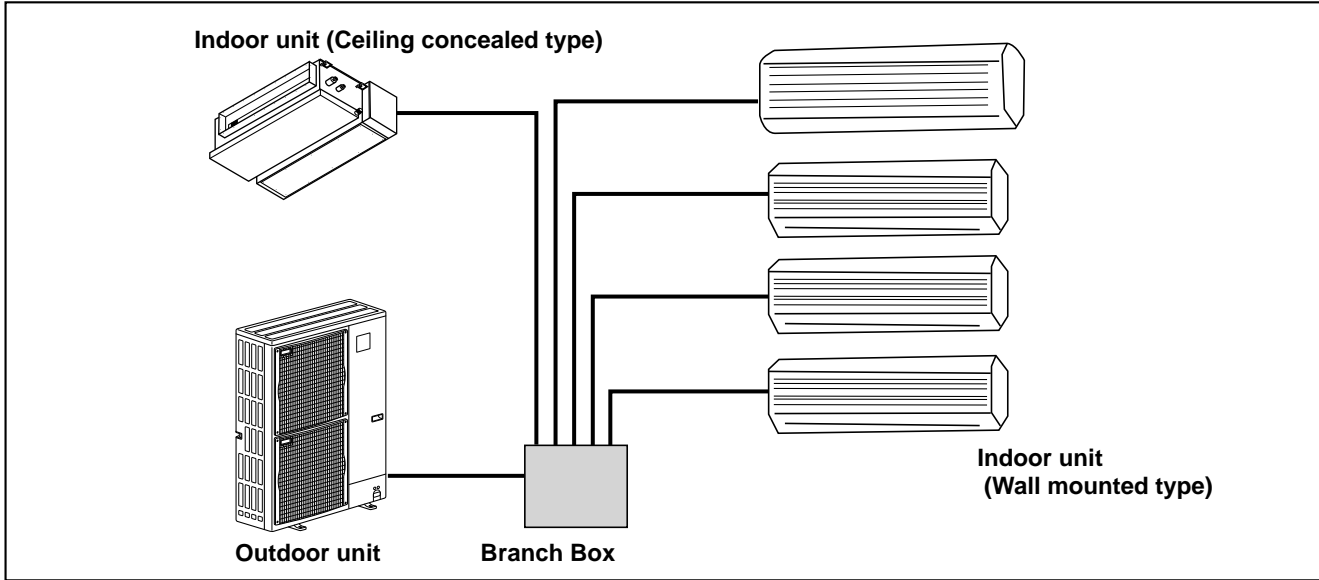

2-2-2. Method for identifying

■ Outdoor unit

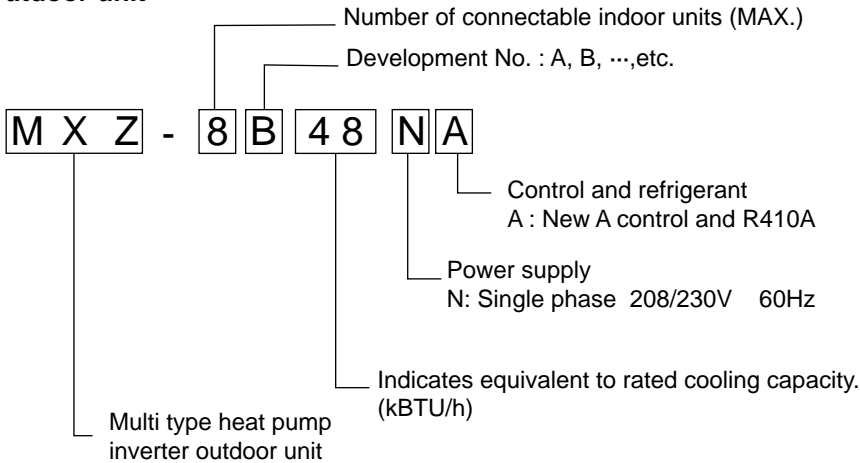

■ Branch box

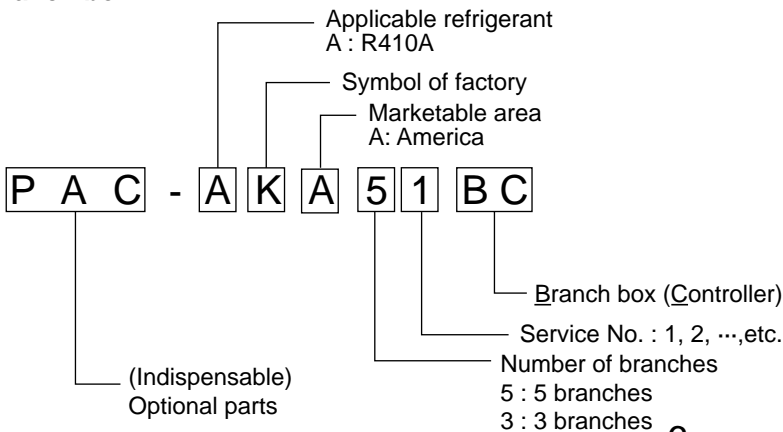

2-3. TYPICAL COMBINATION EXAMPLE

Branch box is located **INSIDE** of condominium

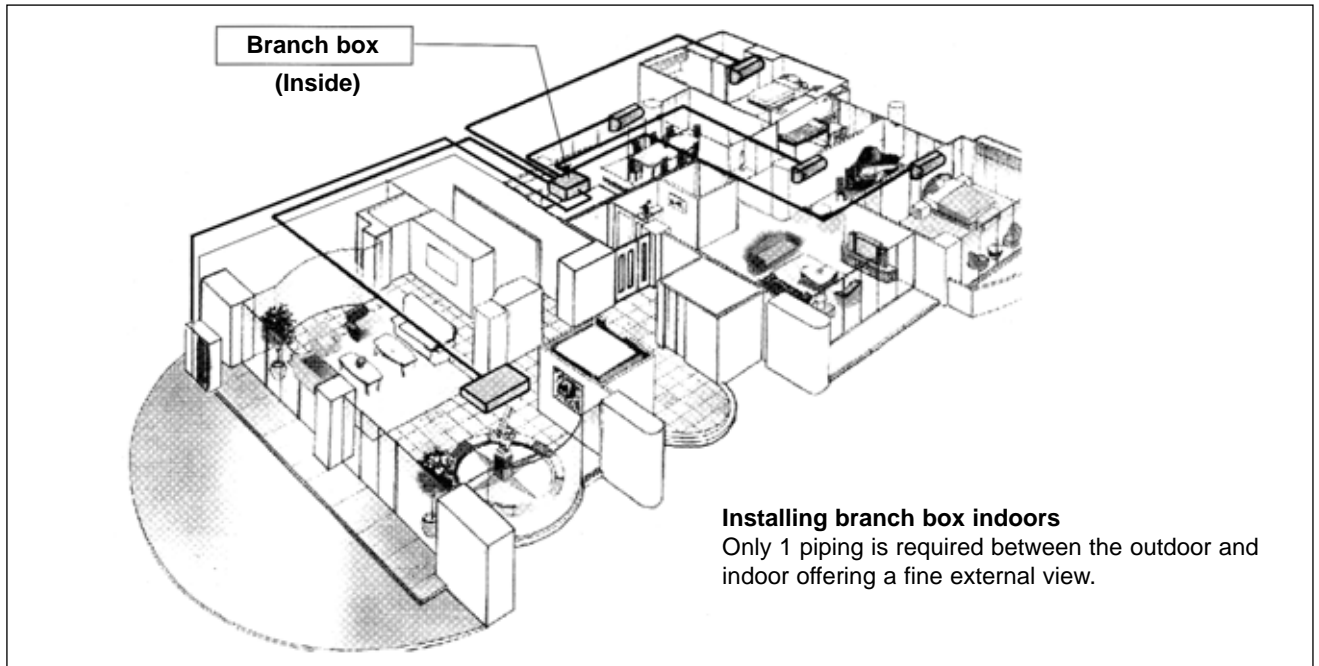

■ System example of 5 indoor units

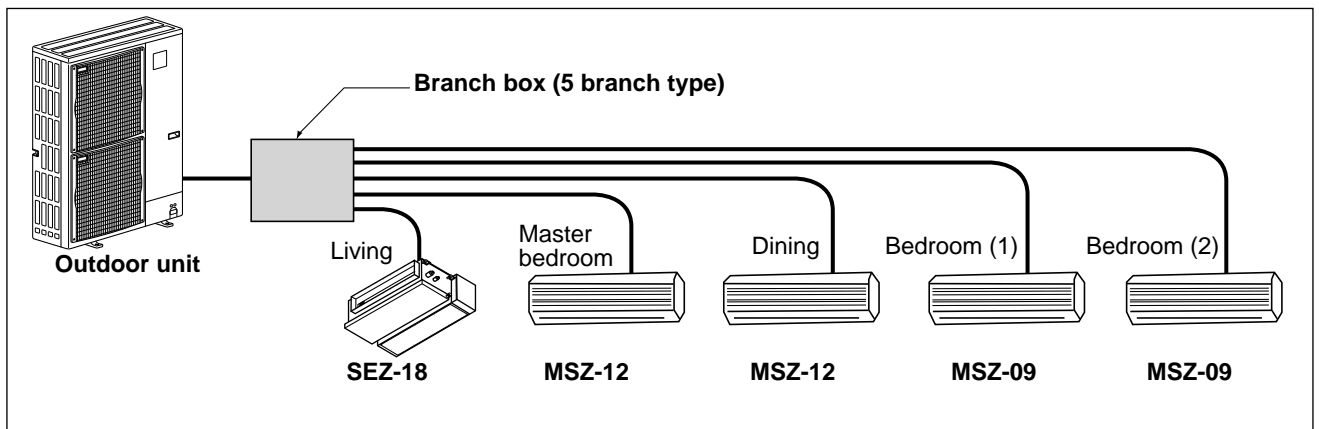

■ Verification

The rated capacity should be determined by observing the table below. The unit's quantities are limited in 2 to 8 units. For the next step, make sure that the selected total rated capacity is in a range of 12 ~ 70.2 kBTU/h.

The total indoor unit capacity should be within the outdoor units. (=54.0 kBTU/h is preferred).

Combination of excessive indoor units and an outdoor unit may reduce the capacity of each indoor unit.

The rated indoor capacity is as the table below.

Example:

SEZ-18	= 18	}	Total rated capacity
	+		
MSZ-12	= 12		
	+		
MSZ-12	= 12		
	+		
MSZ-09	= 9	$60 \leq 70.2 \text{ kBTU/h}$	
	+		
MSZ-09	= 9		
	+		

Indoor unit type (capacity class)	06	09	12	15	18	24
Rated capacity (cooling) (kBTU/h)	6	9	12	15	18	24

2-4. SIMPLIFIED PIPING SYSTEM

Piping connection size

	A	B
Liquid	φ9.52 mm (3/8 inch)	The piping connection size differs according to the type and capacity of indoor units. Match the piping connection size of branch box with indoor unit. If the piping connection size of branch box does not match the piping connection size of indoor unit, use optional different-diameter (deformed) joints to the branch box side. (Connect deformed joint directly to the branch box side.)
Gas	φ15.88 mm (5/8 inch)	

Flare connection employed. (No brazing!)

- In case of using 1-branch box
Flare connection employed (No. brazing)

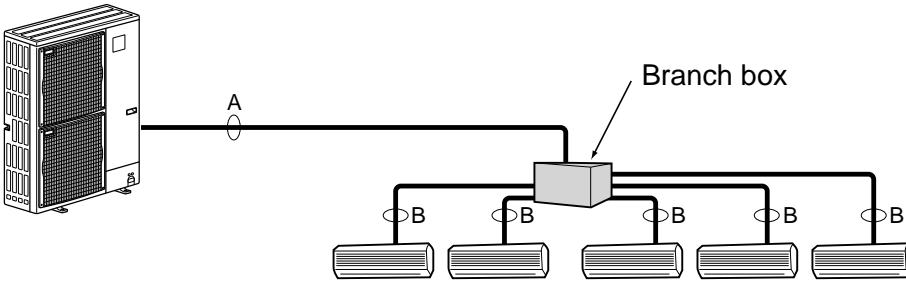

- In case of using 2-branch boxes

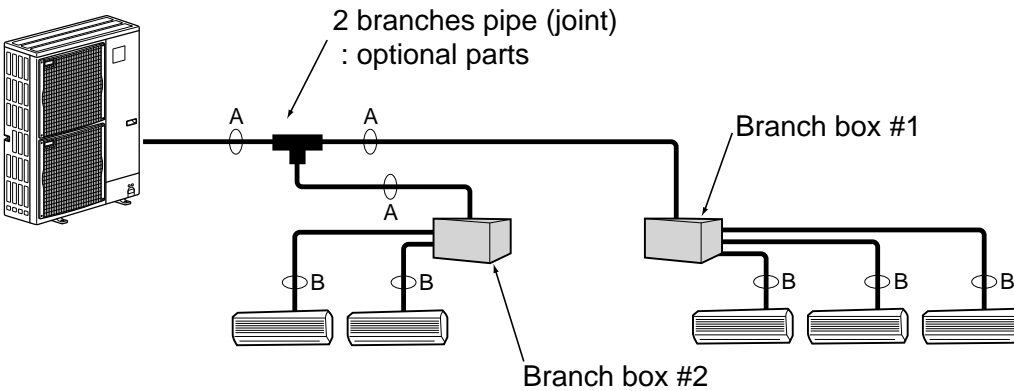

- Installation procedure (2 branch pipe (joint))
Refer to the installation manuals of MSDD-50AR-E and MSDD-50BR-E.

• **Branch box : PAC-AKA51BC PAC-AKA31BC**

Model name				PAC-AKA51BC		PAC-AKA31BC	
Connectable number of indoor units				MAX. 5		MAX. 3	
Power supply (from outdoor unit)				Single phase, 208/230V, 60Hz			
Input		kW		0.003			
Running current		A		0.05			
External finish				Galvanized sheets			
Drain hose size (on site)		mm (in.)		O.D.20 (O.D. 3/4)			
Dimensions	Width		mm (in.)	450 (17 - 3/4)			
	Depth		mm (in.)	280 (11)			
	Height		mm (in.)	198 (7 - 3/4)			
Weight		kg (lbs)		9.6 (21)		8.4 (19)	
Piping connection (Flare)	Branch (indoor side) *	Liquid	mm (in.)	$\phi 6.35 (1/4) \times 5 \{A,B,C,D,E\}$		$\phi 6.35 (1/4) \times 3 \{A,B,C\}$	
		Gas	mm (in.)	$\phi 9.52 (3/8) \times 4 \{A,B,C,D\}, \phi 12.7 (1/2) \times 1\{E\}$		$\phi 9.52 (3/8) \times 3 \{A,B,C\}$	
	Main (outdoor side)	Liquid	mm (in.)	$\phi 9.52 (3/8)$			
		Gas	mm (in.)	$\phi 15.88 (5/8)$			
Wiring	To indoor unit			Each 3-wire, plus earth wire			
	To outdoor unit			3-wire, plus earth wire			

* The piping connection size differs according to the type and capacity of indoor units. Match the piping connection size for indoor and branch box. If the piping connection size of branch box does not match the piping connection size of indoor units, use optional different-diameter (deformed) joints to the branch box side. (Connect deformed joint directly to the branch box side.)

4

DATA

4-1. CAPACITY AND CHARACTERISTICS

Note:

- Cooling capacity is based on D.B. 26.7 °C / W.B. 19.4 °C (D.B. 80 °F / W.B. 67 °F) (indoor temperature), D.B. 35 °C (D.B. 95 °F) (outdoor temperature).
- Heating capacity is based on D.B. 21.1 °C (D.B. 70 °F) (indoor temperature), D.B. 8.3 °C / W.B. 6.1 °C (D.B. 47 °F / W.B. 43 °F) (outdoor temperature).

The rated capacities below show the rise in the indoor unit connection capacity when operating frequency is constant. Values for changes in capacity are fixed after accounting for variations in operating frequency and should be used as reference values.

- **Please refer not to the table below but to "Installation manual" for the breaker selection.**

(1) Cooling mode

<Cooling>

Indoor unit combinations			Capacity of each unit (BTU/h)			Total rated capacity (BTU/h)	Outdoor unit input (W)	Outdoor unit current (A)	
Unit A	Unit B	Unit C	Unit A	Unit B	Unit C			208V	230V
06	-	-	6000	-	-	6000	900	4.4	4.0
09	-	-	9000	-	-	9000	1180	5.8	5.2
12	-	-	12000	-	-	12000	1410	6.9	6.2
15	-	-	15000	-	-	15000	1590	7.8	7.0
18	-	-	18000	-	-	18000	1780	8.7	7.8
24	-	-	24000	-	-	24000	2290	11.2	10.1
06	06	-	6000	6000	-	12000	1410	6.9	6.2
06	09	-	6000	9000	-	15000	1590	7.8	7.0
06	12	-	6000	12000	-	18000	1780	8.7	7.8
06	15	-	6000	15000	-	21000	2040	9.9	9.0
06	18	-	6000	18000	-	24000	2290	11.2	10.1
06	24	-	6000	24000	-	30000	2780	13.6	12.3
09	09	-	9000	9000	-	18000	1780	8.7	7.8
09	12	-	9000	12000	-	21000	2040	9.9	9.0
09	15	-	9000	15000	-	24000	2290	11.2	10.1
09	18	-	9000	18000	-	27000	2540	12.4	11.2
09	24	-	9000	24000	-	33000	3010	14.7	13.3
12	12	-	12000	12000	-	24000	2290	11.2	10.1
12	15	-	12000	15000	-	27000	2540	12.4	11.2
12	18	-	12000	18000	-	30000	2780	13.6	12.3
12	24	-	12000	24000	-	36000	3390	16.5	14.9
15	15	-	15000	15000	-	30000	2780	13.6	12.3
15	18	-	15000	18000	-	33000	3010	14.7	13.3
15	24	-	15000	24000	-	39000	3910	19.1	17.2
18	18	-	18000	18000	-	36000	3390	16.5	14.9
18	24	-	18000	24000	-	42000	4510	22.0	19.9
24	24	-	24000	24000	-	48000	5900	28.8	26.0
06	06	06	6000	6000	6000	18000	1780	8.7	7.8
06	06	09	6000	6000	9000	21000	2040	9.9	9.0
06	06	12	6000	6000	12000	24000	2290	11.2	10.1
06	06	15	6000	6000	15000	27000	2540	12.4	11.2
06	06	18	6000	6000	18000	30000	2780	13.6	12.3
06	06	24	6000	6000	24000	36000	3390	16.5	14.9
06	09	09	6000	9000	9000	24000	2290	11.2	10.1
06	09	12	6000	9000	12000	27000	2540	12.4	11.2
06	09	15	6000	9000	15000	30000	2780	13.6	12.3
06	09	18	6000	9000	18000	33000	3010	14.7	13.3
06	09	24	6000	9000	24000	39000	3910	19.1	17.2
06	12	12	6000	12000	12000	30000	2780	13.6	12.3
06	12	15	6000	12000	15000	33000	3010	14.7	13.3
06	12	18	6000	12000	18000	36000	3390	16.5	14.9
06	12	24	6000	12000	24000	42000	4510	22.0	19.9
06	15	15	6000	15000	15000	36000	3390	16.5	14.9
06	15	18	6000	15000	18000	39000	3910	19.1	17.2
06	15	24	6000	15000	24000	45000	5190	25.3	22.9
06	18	18	6000	18000	18000	42000	4510	22.0	19.9
06	18	24	6000	18000	24000	48000	5900	28.8	26.0
06	24	24	6000	24000	24000	54000	5400	26.3	23.8

<Cooling>

Indoor unit combinations				Capacity of each unit (BTU/h)				Total rated capacity (BTU/h)	Outdoor unit input (W)	Outdoor unit current (A)	
Unit A	Unit B	Unit C	Unit D	Unit A	Unit B	Unit C	Unit D			208V	230V
09	09	09	-	9000	9000	9000	-	27000	2540	12.4	11.2
09	09	12	-	9000	9000	12000	-	30000	2780	13.6	12.3
09	09	15	-	9000	9000	15000	-	33000	3010	14.7	13.3
09	09	18	-	9000	9000	18000	-	36000	3390	16.5	14.9
09	09	24	-	9000	9000	24000	-	42000	4510	22.0	19.9
09	12	12	-	9000	12000	12000	-	33000	3010	14.7	13.3
09	12	15	-	9000	12000	15000	-	36000	3390	16.5	14.9
09	12	18	-	9000	12000	18000	-	39000	3910	19.1	17.2
09	12	24	-	9000	12000	24000	-	45000	5190	25.3	22.9
09	15	15	-	9000	15000	15000	-	39000	3910	19.1	17.2
09	15	18	-	9000	15000	18000	-	42000	4510	22.0	19.9
09	15	24	-	9000	15000	24000	-	48000	5900	28.8	26.0
09	18	18	-	9000	18000	18000	-	45000	5190	25.3	22.9
09	18	24	-	9000	18000	24000	-	51000	5620	27.4	24.8
09	24	24	-	8530	22740	22740	-	54010	4940	24.1	21.8
12	12	12	-	12000	12000	12000	-	36000	3390	16.5	14.9
12	12	15	-	12000	12000	15000	-	39000	3910	19.1	17.2
12	12	18	-	12000	12000	18000	-	42000	4510	22.0	19.9
12	12	24	-	12000	12000	24000	-	48000	5900	28.8	26.0
12	15	15	-	12000	15000	15000	-	42000	4510	22.0	19.9
12	15	18	-	12000	15000	18000	-	45000	5190	25.3	22.9
12	15	24	-	12000	15000	24000	-	51000	5620	27.4	24.8
12	18	18	-	12000	18000	18000	-	48000	5900	28.8	26.0
12	18	24	-	12000	18000	24000	-	54000	5400	26.3	23.8
12	24	24	-	10800	21600	21600	-	54000	4550	22.2	20.1
15	15	15	-	15000	15000	15000	-	45000	5190	25.3	22.9
15	15	18	-	15000	15000	18000	-	48000	5900	28.8	26.0
15	15	24	-	15000	15000	24000	-	54000	5400	26.3	23.8
15	18	18	-	15000	18000	18000	-	51000	5620	27.4	24.8
15	18	24	-	14210	17050	22740	-	54000	4940	24.1	21.8
15	24	24	-	12860	20570	20570	-	54000	4220	20.6	18.6
18	18	18	-	18000	18000	18000	-	54000	5400	26.3	23.8
18	18	24	-	16200	16200	21600	-	54000	4550	22.2	20.1
18	24	24	-	14730	19640	19640	-	54010	3930	19.2	17.3
06	06	06	06	6000	6000	6000	6000	24000	2290	11.2	10.1
06	06	06	09	6000	6000	6000	9000	27000	2540	12.4	11.2
06	06	06	12	6000	6000	6000	12000	30000	2780	13.6	12.3
06	06	06	15	6000	6000	6000	15000	33000	3010	14.7	13.3
06	06	06	18	6000	6000	6000	18000	36000	3390	16.5	14.9
06	06	06	24	6000	6000	6000	24000	42000	4510	22.0	19.9
06	06	09	09	6000	6000	9000	9000	30000	2780	13.6	12.3
06	06	09	12	6000	6000	9000	12000	33000	3010	14.7	13.3
06	06	09	15	6000	6000	9000	15000	36000	3390	16.5	14.9
06	06	09	18	6000	6000	9000	18000	39000	3910	19.1	17.2
06	06	09	24	6000	6000	9000	24000	45000	5190	25.3	22.9
06	06	12	12	6000	6000	12000	12000	36000	3390	16.5	14.9
06	06	12	15	6000	6000	12000	15000	39000	3910	19.1	17.2
06	06	12	18	6000	6000	12000	18000	42000	4510	22.0	19.9
06	06	12	24	6000	6000	12000	24000	48000	5900	28.8	26.0
06	06	15	15	6000	6000	15000	15000	42000	4510	22.0	19.9
06	06	15	18	6000	6000	15000	18000	45000	5190	25.3	22.9
06	06	15	24	6000	6000	15000	24000	51000	5620	27.4	24.8
06	06	18	18	6000	6000	18000	18000	48000	5900	28.8	26.0
06	06	18	24	6000	6000	18000	24000	54000	5400	26.3	23.8
06	06	24	24	5400	5400	21600	21600	54000	4550	22.2	20.1

<Cooling>

Indoor unit combinations				Capacity of each unit (BTU/h)				Total rated capacity (BTU/h)	Outdoor unit input (W)	Outdoor unit current (A)	
Unit A	Unit B	Unit C	Unit D	Unit A	Unit B	Unit C	Unit D			208V	230V
06	09	09	09	6000	9000	9000	9000	33000	3010	14.7	13.3
06	09	09	12	6000	9000	9000	12000	36000	3390	16.5	14.9
06	09	09	15	6000	9000	9000	15000	39000	3910	19.1	17.2
06	09	09	18	6000	9000	9000	18000	42000	4510	22.0	19.9
06	09	09	24	6000	9000	9000	24000	48000	5900	28.8	26.0
06	09	12	12	6000	9000	12000	12000	39000	3910	19.1	17.2
06	09	12	15	6000	9000	12000	15000	42000	4510	22.0	19.9
06	09	12	18	6000	9000	12000	18000	45000	5190	25.3	22.9
06	09	12	24	6000	9000	12000	24000	51000	5620	27.4	24.8
06	09	15	15	6000	9000	15000	15000	45000	5190	25.3	22.9
06	09	15	18	6000	9000	15000	18000	48000	5900	28.8	26.0
06	09	15	24	6000	9000	15000	24000	54000	5400	26.3	23.8
06	09	18	18	6000	9000	18000	18000	51000	5620	27.4	24.8
06	09	18	24	5680	8530	17050	22740	54000	4940	24.1	21.8
06	09	24	24	5140	7710	20570	20570	53990	4220	20.6	18.6
06	12	12	12	6000	12000	12000	12000	42000	4510	22.0	19.9
06	12	12	15	6000	12000	12000	15000	45000	5190	25.3	22.9
06	12	12	18	6000	12000	12000	18000	48000	5900	28.8	26.0
06	12	12	24	6000	12000	12000	24000	54000	5400	26.3	23.8
06	12	15	15	6000	12000	15000	15000	48000	5900	28.8	26.0
06	12	15	18	6000	12000	15000	18000	51000	5620	27.4	24.8
06	12	15	24	5680	11370	14210	22740	54000	4940	24.1	21.8
06	12	18	18	6000	12000	18000	18000	54000	5400	26.3	23.8
06	12	18	24	5400	10800	16200	21600	54000	4550	22.2	20.1
06	12	24	24	4910	9820	19640	19640	54010	3930	19.2	17.3
06	15	15	15	6000	15000	15000	15000	51000	5620	27.4	24.8
06	15	15	18	6000	15000	15000	18000	54000	5400	26.3	23.8
06	15	15	24	5400	13500	13500	21600	54000	4550	22.2	20.1
06	15	18	18	5680	14210	17050	17050	53990	4940	24.1	21.8
06	15	18	24	5140	12860	15430	20570	54000	4220	20.6	18.6
06	15	24	24	4700	11740	18780	18780	54000	3680	17.9	16.2
06	18	18	18	5400	16200	16200	16200	54000	4550	22.2	20.1
06	18	18	24	4910	14730	14730	19640	54010	3930	19.2	17.3
09	09	09	09	9000	9000	9000	9000	36000	3390	16.5	14.9
09	09	09	12	9000	9000	9000	12000	39000	3910	19.1	17.2
09	09	09	15	9000	9000	9000	15000	42000	4510	22.0	19.9
09	09	09	18	9000	9000	9000	18000	45000	5190	25.3	22.9
09	09	09	24	9000	9000	9000	24000	51000	5620	27.4	24.8
09	09	12	12	9000	9000	12000	12000	42000	4510	22.0	19.9
09	09	12	15	9000	9000	12000	15000	45000	5190	25.3	22.9
09	09	12	18	9000	9000	12000	18000	48000	5900	28.8	26.0
09	09	12	24	9000	9000	12000	24000	54000	5400	26.3	23.8
09	09	15	15	9000	9000	15000	15000	48000	5900	28.8	26.0
09	09	15	18	9000	9000	15000	18000	51000	5620	27.4	24.8
09	09	15	24	8530	8530	14210	22740	54010	4940	24.1	21.8
09	09	18	18	9000	9000	18000	18000	54000	5400	26.3	23.8
09	09	18	24	8100	8100	16200	21600	54000	4550	22.2	20.1
09	09	24	24	7360	7360	19640	19640	54000	3930	19.2	17.3
09	12	12	12	9000	12000	12000	12000	45000	5190	25.3	22.9
09	12	12	15	9000	12000	12000	15000	48000	5900	28.8	26.0
09	12	12	18	9000	12000	12000	18000	51000	5620	27.4	24.8
09	12	12	24	8530	11370	11370	22740	54010	4940	24.1	21.8
09	12	15	15	9000	12000	15000	15000	51000	5620	27.4	24.8
09	12	15	18	9000	12000	15000	18000	54000	5400	26.3	23.8
09	12	15	24	8100	10800	13500	21600	54000	4550	22.2	20.1
09	12	18	18	8530	11370	17050	17050	54000	4940	24.1	21.8
09	12	18	24	7710	10290	15430	20570	54000	4220	20.6	18.6

<Cooling>

Indoor unit combinations					Capacity of each unit (BTU/h)					Total rated capacity (BTU/h)	Outdoor unit input (W)	Outdoor unit current (A)	
Unit A	Unit B	Unit C	Unit D	Unit E	Unit A	Unit B	Unit C	Unit D	Unit E			208V	230V
09	12	24	24	-	7040	9390	18780	18780	-	53990	3680	17.9	16.2
09	15	15	15	-	9000	15000	15000	15000	-	54000	5400	26.3	23.8
09	15	15	18	-	8530	14210	14210	17050	-	54000	4940	24.1	21.8
09	15	15	24	-	7710	12860	12860	20570	-	54000	4220	20.6	18.6
09	15	18	18	-	8100	13500	16200	16200	-	54000	4550	22.2	20.1
09	15	18	24	-	7360	12270	14730	19640	-	54000	3930	19.2	17.3
09	18	18	18	-	7710	15430	15430	15430	-	54000	4220	20.6	18.6
09	18	18	24	-	7040	14090	14090	18780	-	54000	3680	17.9	16.2
12	12	12	12	-	12000	12000	12000	12000	-	48000	5900	28.8	26.0
12	12	12	15	-	12000	12000	12000	15000	-	51000	5620	27.4	24.8
12	12	12	18	-	12000	12000	12000	18000	-	54000	5400	26.3	23.8
12	12	12	24	-	10800	10800	10800	21600	-	54000	4550	22.2	20.1
12	12	15	15	-	12000	12000	15000	15000	-	54000	5400	26.3	23.8
12	12	15	18	-	11370	11370	14210	17050	-	54000	4940	24.1	21.8
12	12	15	24	-	10290	10290	12860	20570	-	54010	4220	20.6	18.6
12	12	18	18	-	10800	10800	16200	16200	-	54000	4550	22.2	20.1
12	12	18	24	-	9820	9820	14730	19640	-	54010	3930	19.2	17.3
12	15	15	15	-	11370	14210	14210	14210	-	54000	4940	24.1	21.8
12	15	15	18	-	10800	13500	13500	16200	-	54000	4550	22.2	20.1
12	15	15	24	-	9820	12270	12270	19640	-	54000	3930	19.2	17.3
12	15	18	18	-	10290	12860	15430	15430	-	54010	4220	20.6	18.6
12	15	18	24	-	9390	11740	14090	18780	-	54000	3680	17.9	16.2
12	18	18	18	-	9820	14730	14730	14730	-	54010	3930	19.2	17.3
15	15	15	15	-	13500	13500	13500	13500	-	54000	4550	22.2	20.1
15	15	15	18	-	12860	12860	12860	15430	-	54010	4220	20.6	18.6
15	15	15	24	-	11740	11740	11740	18780	-	54000	3680	17.9	16.2
15	15	18	18	-	12270	12270	14730	14730	-	54000	3930	19.2	17.3
15	18	18	18	-	11740	14090	14090	14090	-	54010	3680	17.9	16.2
06	06	06	06	06	6000	6000	6000	6000	6000	30000	2780	13.6	12.3
06	06	06	06	09	6000	6000	6000	6000	9000	33000	3010	14.7	13.3
06	06	06	06	12	6000	6000	6000	6000	12000	36000	3390	16.5	14.9
06	06	06	06	15	6000	6000	6000	6000	15000	39000	3910	19.1	17.2
06	06	06	06	18	6000	6000	6000	6000	18000	42000	4510	22.0	19.9
06	06	06	06	24	6000	6000	6000	6000	24000	48000	5900	28.8	26.0
06	06	06	09	09	6000	6000	6000	9000	9000	36000	3390	16.5	14.9
06	06	06	09	12	6000	6000	6000	9000	12000	39000	3910	19.1	17.2
06	06	06	09	15	6000	6000	6000	9000	15000	42000	4510	22.0	19.9
06	06	06	09	18	6000	6000	6000	9000	18000	45000	5190	25.3	22.9
06	06	06	09	24	6000	6000	6000	9000	24000	51000	5620	27.4	24.8
06	06	06	12	12	6000	6000	6000	12000	12000	42000	4510	22.0	19.9
06	06	06	12	15	6000	6000	6000	12000	15000	45000	5190	25.3	22.9
06	06	06	12	18	6000	6000	6000	12000	18000	48000	5900	28.8	26.0
06	06	06	12	24	6000	6000	6000	12000	24000	54000	5400	26.3	23.8
06	06	06	15	15	6000	6000	6000	15000	15000	48000	5900	28.8	26.0
06	06	06	15	18	6000	6000	6000	15000	18000	51000	5620	27.4	24.8
06	06	06	15	24	5680	5680	5680	14210	22740	53990	4940	24.1	21.8
06	06	06	18	18	6000	6000	6000	18000	18000	54000	5400	26.3	23.8
06	06	06	18	24	5400	5400	5400	16200	21600	54000	4550	22.2	20.1
06	06	06	24	24	4910	4910	4910	19640	19640	54010	3930	19.2	17.3
06	06	09	09	09	6000	6000	9000	9000	9000	39000	3910	19.1	17.2
06	06	09	09	12	6000	6000	9000	9000	12000	42000	4510	22.0	19.9
06	06	09	09	15	6000	6000	9000	9000	15000	45000	5190	25.3	22.9
06	06	09	09	18	6000	6000	9000	9000	18000	48000	5900	28.8	26.0
06	06	09	09	24	6000	6000	9000	9000	24000	54000	5400	26.3	23.8
06	06	09	12	12	6000	6000	9000	12000	12000	45000	5190	25.3	22.9
06	06	09	12	15	6000	6000	9000	12000	15000	48000	5900	28.8	26.0
06	06	09	12	18	6000	6000	9000	12000	18000	51000	5620	27.4	24.8

<Cooling>

Indoor unit combinations					Capacity of each unit (BTU/h)					Total rated capacity (BTU/h)	Outdoor unit input (W)	Outdoor unit current (A)	
Unit A	Unit B	Unit C	Unit D	Unit E	Unit A	Unit B	Unit C	Unit D	Unit E			208V	230V
06	06	09	12	24	5680	5680	8530	11370	22740	54000	4940	24.1	21.8
06	06	09	15	15	6000	6000	9000	15000	15000	51000	5620	27.4	24.8
06	06	09	15	18	6000	6000	9000	15000	18000	54000	5400	26.3	23.8
06	06	09	15	24	5400	5400	8100	13500	21600	54000	4550	22.2	20.1
06	06	09	18	18	5680	5680	8530	17050	17050	53990	4940	24.1	21.8
06	06	09	18	24	5140	5140	7710	15430	20570	53990	4220	20.6	18.6
06	06	09	24	24	4700	4700	7040	18780	18780	54000	3680	17.9	16.2
06	06	12	12	12	6000	6000	12000	12000	12000	48000	5900	28.8	26.0
06	06	12	12	15	6000	6000	12000	12000	15000	51000	5620	27.4	24.8
06	06	12	12	18	6000	6000	12000	12000	18000	54000	5400	26.3	23.8
06	06	12	12	24	5400	5400	10800	10800	21600	54000	4550	22.2	20.1
06	06	12	15	15	6000	6000	12000	15000	15000	54000	5400	26.3	23.8
06	06	12	15	18	5680	5680	11370	14210	17050	53990	4940	24.1	21.8
06	06	12	15	24	5140	5140	10290	12860	20570	54000	4220	20.6	18.6
06	06	12	18	18	5400	5400	10800	16200	16200	54000	4550	22.2	20.1
06	06	12	18	24	4910	4910	9820	14730	19640	54010	3930	19.2	17.3
06	06	15	15	15	5680	5680	14210	14210	14210	53990	4940	24.1	21.8
06	06	15	15	18	5400	5400	13500	13500	16200	54000	4550	22.2	20.1
06	06	15	15	24	4910	4910	12270	12270	19640	54000	3930	19.2	17.3
06	06	15	18	18	5140	5140	12860	15430	15430	54000	4220	20.6	18.6
06	06	15	18	24	4700	4700	11740	14090	18780	54010	3680	17.9	16.2
06	06	18	18	18	4910	4910	14730	14730	14730	54010	3930	19.2	17.3
06	09	09	09	09	6000	9000	9000	9000	9000	42000	4510	22.0	19.9
06	09	09	09	12	6000	9000	9000	9000	12000	45000	5190	25.3	22.9
06	09	09	09	15	6000	9000	9000	9000	15000	48000	5900	28.8	26.0
06	09	09	09	18	6000	9000	9000	9000	18000	51000	5620	27.4	24.8
06	09	09	09	24	5680	8530	8530	8530	22740	54010	4940	24.1	21.8
06	09	09	12	12	6000	9000	9000	12000	12000	48000	5900	28.8	26.0
06	09	09	12	15	6000	9000	9000	12000	15000	51000	5620	27.4	24.8
06	09	09	12	18	6000	9000	9000	12000	18000	54000	5400	26.3	23.8
06	09	09	12	24	5400	8100	8100	10800	21600	54000	4550	22.2	20.1
06	09	09	15	15	6000	9000	9000	15000	15000	54000	5400	26.3	23.8
06	09	09	15	18	5680	8530	8530	14210	17050	54000	4940	24.1	21.8
06	09	09	15	24	5140	7710	7710	12860	20570	53990	4220	20.6	18.6
06	09	09	18	18	5400	8100	8100	16200	16200	54000	4550	22.2	20.1
06	09	09	18	24	4910	7360	7360	14730	19640	54000	3930	19.2	17.3
06	09	12	12	12	6000	9000	12000	12000	12000	51000	5620	27.4	24.8
06	09	12	12	15	6000	9000	12000	12000	15000	54000	5400	26.3	23.8
06	09	12	12	18	5680	8530	11370	11370	17050	54000	4940	24.1	21.8
06	09	12	12	24	5140	7710	10290	10290	20570	54000	4220	20.6	18.6
06	09	12	15	15	5680	8530	11370	14210	14210	54000	4940	24.1	21.8
06	09	12	15	18	5400	8100	10800	13500	16200	54000	4550	22.2	20.1
06	09	12	15	24	4910	7360	9820	12270	19640	54000	3930	19.2	17.3
06	09	12	18	18	5140	7710	10290	15430	15430	54000	4220	20.6	18.6
06	09	12	18	24	4700	7040	9390	14090	18780	54000	3680	17.9	16.2
06	09	15	15	15	5400	8100	13500	13500	13500	54000	4550	22.2	20.1
06	09	15	15	18	5140	7710	12860	12860	15430	54000	4220	20.6	18.6
06	09	15	15	24	4700	7040	11740	11740	18780	54000	3680	17.9	16.2
06	09	15	18	18	4910	7360	12270	14730	14730	54000	3930	19.2	17.3
06	09	18	18	18	4700	7040	14090	14090	14090	54010	3680	17.9	16.2
06	12	12	12	12	6000	12000	12000	12000	12000	54000	5400	26.3	23.8
06	12	12	12	15	5680	11370	11370	11370	14210	54000	4940	24.1	21.8
06	12	12	12	18	5400	10800	10800	10800	16200	54000	4550	22.2	20.1
06	12	12	12	24	4910	9820	9820	9820	19640	54010	3930	19.2	17.3
06	12	12	15	15	5400	10800	10800	13500	13500	54000	4550	22.2	20.1
06	12	12	15	18	5140	10290	10290	12860	15430	54010	4220	20.6	18.6
06	12	12	15	24	4700	9390	9390	11740	18780	54000	3680	17.9	16.2

<Cooling>

Indoor unit combinations						Capacity of each unit (BTU/h)						Total rated capacity (BTU/h)	Outdoor unit input (W)	Outdoor unit current (A)	
Unit						Unit A	Unit B	Unit C	Unit D	Unit E	Unit F			208V	230V
A	B	C	D	E	F										
06	12	12	18	18	-	4910	9820	9820	14730	14730	-	54010	3930	19.2	17.3
06	12	15	15	15	-	5140	10290	12860	12860	12860	-	54010	4220	20.6	18.6
06	12	15	15	18	-	4910	9820	12270	12270	14730	-	54000	3930	19.2	17.3
06	12	15	18	18	-	4700	9390	11740	14090	14090	-	54010	3680	17.9	16.2
06	15	15	15	15	-	4910	12270	12270	12270	12270	-	53990	3930	19.2	17.3
06	15	15	15	18	-	4700	11740	11740	11740	14090	-	54010	3680	17.9	16.2
09	09	09	09	09	-	9000	9000	9000	9000	9000	-	45000	5190	25.3	22.9
09	09	09	09	12	-	9000	9000	9000	9000	12000	-	48000	5900	28.8	26.0
09	09	09	09	15	-	9000	9000	9000	9000	15000	-	51000	5620	27.4	24.8
09	09	09	09	18	-	9000	9000	9000	9000	18000	-	54000	5400	26.3	23.8
09	09	09	09	24	-	8100	8100	8100	8100	21600	-	54000	4550	22.2	20.1
09	09	09	12	12	-	9000	9000	9000	12000	12000	-	51000	5620	27.4	24.8
09	09	09	12	15	-	9000	9000	9000	12000	15000	-	54000	5400	26.3	23.8
09	09	09	12	18	-	8530	8530	8530	11370	17050	-	54010	4940	24.1	21.8
09	09	09	12	24	-	7710	7710	7710	10290	20570	-	53990	4220	20.6	18.6
09	09	09	15	15	-	8530	8530	8530	14210	14210	-	54010	4940	24.1	21.8
09	09	09	15	18	-	8100	8100	8100	13500	16200	-	54000	4550	22.2	20.1
09	09	09	15	24	-	7360	7360	7360	12270	19640	-	53990	3930	19.2	17.3
09	09	09	18	18	-	7710	7710	7710	15430	15430	-	53990	4220	20.6	18.6
09	09	09	18	24	-	7040	7040	7040	14090	18780	-	53990	3680	17.9	16.2
09	09	12	12	12	-	9000	9000	12000	12000	12000	-	54000	5400	26.3	23.8
09	09	12	12	15	-	8530	8530	11370	11370	14210	-	54010	4940	24.1	21.8
09	09	12	12	18	-	8100	8100	10800	10800	16200	-	54000	4550	22.2	20.1
09	09	12	12	24	-	7360	7360	9820	9820	19640	-	54000	3930	19.2	17.3
09	09	12	15	15	-	8100	8100	10800	13500	13500	-	54000	4550	22.2	20.1
09	09	12	15	18	-	7710	7710	10290	12860	15430	-	54000	4220	20.6	18.6
09	09	12	15	24	-	7040	7040	9390	11740	18780	-	53990	3680	17.9	16.2
09	09	12	18	18	-	7360	7360	9820	14730	14730	-	54000	3930	19.2	17.3
09	09	15	15	15	-	7710	7710	12860	12860	12860	-	54000	4220	20.6	18.6
09	09	15	15	18	-	7360	7360	12270	12270	14730	-	53990	3930	19.2	17.3
09	09	15	18	18	-	7040	7040	11740	14090	14090	-	54000	3680	17.9	16.2
09	12	12	12	12	-	8530	11370	11370	11370	11370	-	54010	4940	24.1	21.8
09	12	12	12	15	-	8100	10800	10800	10800	13500	-	54000	4550	22.2	20.1
09	12	12	12	18	-	7710	10290	10290	10290	15430	-	54010	4220	20.6	18.6
09	12	12	12	24	-	7040	9390	9390	9390	18780	-	53990	3680	17.9	16.2
09	12	12	15	15	-	7710	10290	10290	12860	12860	-	54010	4220	20.6	18.6
09	12	12	15	18	-	7360	9820	9820	12270	14730	-	54000	3930	19.2	17.3
09	12	12	18	18	-	7040	9390	9390	14090	14090	-	54000	3680	17.9	16.2
09	12	15	15	15	-	7360	9820	12270	12270	12270	-	53990	3930	19.2	17.3
09	12	15	15	18	-	7040	9390	11740	11740	14090	-	54000	3680	17.9	16.2
09	15	15	15	15	-	7040	11740	11740	11740	11740	-	54000	3680	17.9	16.2
12	12	12	12	12	-	10800	10800	10800	10800	10800	-	54000	4550	22.2	20.1
12	12	12	12	15	-	10290	10290	10290	10290	12860	-	54020	4220	20.6	18.6
12	12	12	12	18	-	9820	9820	9820	9820	14730	-	54010	3930	19.2	17.3
12	12	12	15	15	-	9820	9820	9820	12270	12270	-	54000	3930	19.2	17.3
12	12	12	15	18	-	9390	9390	9390	11740	14090	-	54000	3680	17.9	16.2
12	12	15	15	15	-	9390	9390	11740	11740	11740	-	54000	3680	17.9	16.2
06	06	06	06	06	06	6000	6000	6000	6000	6000	6000	36000	3390	16.5	14.9
06	06	06	06	06	09	6000	6000	6000	6000	6000	9000	39000	3910	19.1	17.2
06	06	06	06	06	12	6000	6000	6000	6000	6000	12000	42000	4510	22.0	19.9
06	06	06	06	06	15	6000	6000	6000	6000	6000	15000	45000	5190	25.3	22.9
06	06	06	06	06	18	6000	6000	6000	6000	6000	18000	48000	5900	28.8	26.0
06	06	06	06	06	24	6000	6000	6000	6000	6000	24000	54000	5400	26.3	23.8
06	06	06	06	09	09	6000	6000	6000	6000	9000	9000	42000	4510	22.0	19.9
06	06	06	06	09	12	6000	6000	6000	6000	9000	12000	45000	5190	25.3	22.9
06	06	06	06	09	15	6000	6000	6000	6000	9000	15000	48000	5900	28.8	26.0
06	06	06	06	09	18	6000	6000	6000	6000	9000	18000	51000	5620	27.4	24.8

<Cooling>

Indoor unit combinations						Capacity of each unit (BTU/h)						Total rated capacity (BTU/h)	Outdoor unit input (W)	Outdoor unit current (A)	
Unit						Unit A	Unit B	Unit C	Unit D	Unit E	Unit F			208V	230V
A	B	C	D	E	F										
06	06	06	06	09	24	5680	5680	5680	5680	8530	22740	53990	4940	24.1	21.8
06	06	06	06	12	12	6000	6000	6000	6000	12000	12000	48000	5900	28.8	26.0
06	06	06	06	12	15	6000	6000	6000	6000	12000	15000	51000	5620	27.4	24.8
06	06	06	06	12	18	6000	6000	6000	6000	12000	18000	54000	5400	26.3	23.8
06	06	06	06	12	24	5400	5400	5400	5400	10800	21600	54000	4550	22.2	20.1
06	06	06	06	15	15	6000	6000	6000	6000	15000	15000	54000	5400	26.3	23.8
06	06	06	06	15	18	5680	5680	5680	5680	14210	17050	53980	4940	24.1	21.8
06	06	06	06	15	24	5140	5140	5140	5140	12860	20570	53990	4220	20.6	18.6
06	06	06	06	18	18	5400	5400	5400	5400	16200	16200	54000	4550	22.2	20.1
06	06	06	06	18	24	4910	4910	4910	4910	14730	19640	54010	3930	19.2	17.3
06	06	06	09	09	09	6000	6000	6000	9000	9000	9000	45000	5190	25.3	22.9
06	06	06	09	09	12	6000	6000	6000	9000	9000	12000	48000	5900	28.8	26.0
06	06	06	09	09	15	6000	6000	6000	9000	9000	15000	51000	5620	27.4	24.8
06	06	06	09	09	18	6000	6000	6000	9000	9000	18000	54000	5400	26.3	23.8
06	06	06	09	09	24	5400	5400	5400	8100	8100	21600	54000	4550	22.2	20.1
06	06	06	09	12	12	6000	6000	6000	9000	12000	12000	51000	5620	27.4	24.8
06	06	06	09	12	15	6000	6000	6000	9000	12000	15000	54000	5400	26.3	23.8
06	06	06	09	12	18	5680	5680	5680	8530	11370	17050	53990	4940	24.1	21.8
06	06	06	09	12	24	5140	5140	5140	7710	10290	20570	53990	4220	20.6	18.6
06	06	06	09	15	15	5680	5680	5680	8530	14210	14210	53990	4940	24.1	21.8
06	06	06	09	15	18	5400	5400	5400	8100	13500	16200	54000	4550	22.2	20.1
06	06	06	09	15	24	4910	4910	4910	7360	12270	19640	54000	3930	19.2	17.3
06	06	06	09	18	18	5140	5140	5140	7710	15430	15430	53990	4220	20.6	18.6
06	06	06	09	18	24	4700	4700	4700	7040	14090	18780	54010	3680	17.9	16.2
06	06	06	12	12	12	6000	6000	6000	12000	12000	12000	54000	5400	26.3	23.8
06	06	06	12	12	15	5680	5680	5680	11370	11370	14210	53990	4940	24.1	21.8
06	06	06	12	12	18	5400	5400	5400	10800	10800	16200	54000	4550	22.2	20.1
06	06	06	12	12	24	4910	4910	4910	9820	9820	19640	54010	3930	19.2	17.3
06	06	06	12	15	15	5400	5400	5400	10800	13500	13500	54000	4550	22.2	20.1
06	06	06	12	15	18	5140	5140	5140	10290	12860	15430	54000	4220	20.6	18.6
06	06	06	12	15	24	4700	4700	4700	9390	11740	18780	54010	3680	17.9	16.2
06	06	06	12	18	18	4910	4910	4910	9820	14730	14730	54010	3930	19.2	17.3
06	06	06	15	15	15	5140	5140	5140	12860	12860	12860	54000	4220	20.6	18.6
06	06	06	15	15	18	4910	4910	4910	12270	12270	14730	54000	3930	19.2	17.3
06	06	06	15	18	18	4700	4700	4700	11740	14090	14090	54020	3680	17.9	16.2
06	06	09	09	09	09	6000	6000	9000	9000	9000	9000	48000	5900	28.8	26.0
06	06	09	09	09	12	6000	6000	9000	9000	9000	12000	51000	5620	27.4	24.8
06	06	09	09	09	15	6000	6000	9000	9000	9000	15000	54000	5400	26.3	23.8
06	06	09	09	09	18	5680	5680	8530	8530	8530	17050	54000	4940	24.1	21.8
06	06	09	09	09	24	5140	5140	7710	7710	7710	20570	53980	4220	20.6	18.6
06	06	09	09	12	12	6000	6000	9000	9000	12000	12000	54000	5400	26.3	23.8
06	06	09	09	12	15	5680	5680	8530	8530	11370	14210	54000	4940	24.1	21.8
06	06	09	09	12	18	5400	5400	8100	8100	10800	16200	54000	4550	22.2	20.1
06	06	09	09	12	24	4910	4910	7360	7360	9820	19640	54000	3930	19.2	17.3
06	06	09	09	15	15	5400	5400	8100	8100	13500	13500	54000	4550	22.2	20.1
06	06	09	09	15	18	5140	5140	7710	7710	12860	15430	53990	4220	20.6	18.6
06	06	09	09	15	24	4700	4700	7040	7040	11740	18780	54000	3680	17.9	16.2
06	06	09	09	18	18	4910	4910	7360	7360	14730	14730	54000	3930	19.2	17.3
06	06	09	12	12	12	5680	5680	8530	11370	11370	11370	54000	4940	24.1	21.8
06	06	09	12	12	15	5400	5400	8100	10800	10800	13500	54000	4550	22.2	20.1
06	06	09	12	12	18	5140	5140	7710	10290	10290	15430	54000	4220	20.6	18.6
06	06	09	12	12	24	4700	4700	7040	9390	9390	18780	54000	3680	17.9	16.2
06	06	09	12	15	15	5140	5140	7710	10290	12860	12860	54000	4220	20.6	18.6
06	06	09	12	15	18	4910	4910	7360	9820	12270	14730	54000	3930	19.2	17.3
06	06	09	12	18	18	4700	4700	7040	9390	14090	14090	54010	3680	17.9	16.2
06	06	09	15	15	15	4910	4910	7360	12270	12270	12270	53990	3930	19.2	17.3
06	06	09	15	15	18	4700	4700	7040	11740	11740	14090	54010	3680	17.9	16.2

<Cooling>

Indoor unit combinations								Capacity of each unit (BTU/h)							Total rated capacity (BTU/h)	Outdoor unit input (W)	Outdoor unit current (A)	
Unit								Unit A	Unit B	Unit C	Unit D	Unit E	Unit F	Unit G			208V	230V
06	06	12	12	12	12	-	-	5400	5400	10800	10800	10800	10800	-	54000	4550	22.2	20.1
06	06	12	12	12	15	-	-	5140	5140	10290	10290	10290	12860	-	54010	4220	20.6	18.6
06	06	12	12	12	18	-	-	4910	4910	9820	9820	9820	14730	-	54010	3930	19.2	17.3
06	06	12	12	15	15	-	-	4910	4910	9820	9820	12270	12270	-	54000	3930	19.2	17.3
06	06	12	12	15	18	-	-	4700	4700	9390	9390	11740	14090	-	54010	3680	17.9	16.2
06	06	12	15	15	15	-	-	4700	4700	9390	11740	11740	11740	-	54010	3680	17.9	16.2
06	09	09	09	09	09	-	-	6000	9000	9000	9000	9000	9000	-	51000	5620	27.4	24.8
06	09	09	09	09	12	-	-	6000	9000	9000	9000	9000	12000	-	54000	5400	26.3	23.8
06	09	09	09	09	15	-	-	5680	8530	8530	8530	8530	14210	-	54010	4940	24.1	21.8
06	09	09	09	09	18	-	-	5400	8100	8100	8100	8100	16200	-	54000	4550	22.2	20.1
06	09	09	09	09	24	-	-	4910	7360	7360	7360	7360	19640	-	53990	3930	19.2	17.3
06	09	09	09	12	12	-	-	5680	8530	8530	8530	11370	11370	-	54010	4940	24.1	21.8
06	09	09	09	12	15	-	-	5400	8100	8100	8100	10800	13500	-	54000	4550	22.2	20.1
06	09	09	09	12	18	-	-	5140	7710	7710	7710	10290	15430	-	53990	4220	20.6	18.6
06	09	09	09	12	24	-	-	4700	7040	7040	7040	9390	18780	-	53990	3680	17.9	16.2
06	09	09	09	15	15	-	-	5140	7710	7710	7710	12860	12860	-	53990	4220	20.6	18.6
06	09	09	09	15	18	-	-	4910	7360	7360	7360	12270	14730	-	53990	3930	19.2	17.3
06	09	09	09	18	18	-	-	4700	7040	7040	7040	14090	14090	-	54000	3680	17.9	16.2
06	09	09	12	12	12	-	-	5400	8100	8100	10800	10800	10800	-	54000	4550	22.2	20.1
06	09	09	12	12	15	-	-	5140	7710	7710	10290	10290	12860	-	54000	4220	20.6	18.6
06	09	09	12	12	18	-	-	4910	7360	7360	9820	9820	14730	-	54000	3930	19.2	17.3
06	09	09	12	15	15	-	-	4910	7360	7360	9820	12270	12270	-	53990	3930	19.2	17.3
06	09	09	12	15	18	-	-	4700	7040	7040	9390	11740	14090	-	54000	3680	17.9	16.2
06	09	09	15	15	15	-	-	4700	7040	7040	11740	11740	11740	-	54000	3680	17.9	16.2
06	09	12	12	12	12	-	-	5140	7710	10290	10290	10290	10290	-	54010	4220	20.6	18.6
06	09	12	12	12	15	-	-	4910	7360	9820	9820	9820	12270	-	54000	3930	19.2	17.3
06	09	12	12	12	18	-	-	4700	7040	9390	9390	9390	14090	-	54000	3680	17.9	16.2
06	09	12	12	15	15	-	-	4700	7040	9390	9390	11740	11740	-	54000	3680	17.9	16.2
06	12	12	12	12	12	-	-	4910	9820	9820	9820	9820	9820	-	54010	3930	19.2	17.3
06	12	12	12	12	15	-	-	4700	9390	9390	9390	9390	11740	-	54000	3680	17.9	16.2
09	09	09	09	09	09	-	-	9000	9000	9000	9000	9000	9000	-	54000	5400	26.3	23.8
09	09	09	09	09	12	-	-	8530	8530	8530	8530	8530	11370	-	54020	4940	24.1	21.8
09	09	09	09	09	15	-	-	8100	8100	8100	8100	8100	13500	-	54000	4550	22.2	20.1
09	09	09	09	09	18	-	-	7710	7710	7710	7710	7710	15430	-	53980	4220	20.6	18.6
09	09	09	09	09	24	-	-	7040	7040	7040	7040	7040	18780	-	53980	3680	17.9	16.2
09	09	09	09	12	12	-	-	8100	8100	8100	8100	10800	10800	-	54000	4550	22.2	20.1
09	09	09	09	12	15	-	-	7710	7710	7710	7710	10290	12860	-	53990	4220	20.6	18.6
09	09	09	09	12	18	-	-	7360	7360	7360	7360	9820	14730	-	53990	3930	19.2	17.3
09	09	09	09	15	15	-	-	7360	7360	7360	7360	12270	12270	-	53980	3930	19.2	17.3
09	09	09	09	15	18	-	-	7040	7040	7040	7040	11740	14090	-	53990	3680	17.9	16.2
09	09	09	12	12	12	-	-	7710	7710	7710	10290	10290	10290	-	54000	4220	20.6	18.6
09	09	09	12	12	15	-	-	7360	7360	7360	9820	9820	12270	-	53990	3930	19.2	17.3
09	09	09	12	12	18	-	-	7040	7040	7040	9390	9390	14090	-	53990	3680	17.9	16.2
09	09	09	12	15	15	-	-	7040	7040	7040	9390	11740	11740	-	53990	3680	17.9	16.2
09	09	12	12	12	12	-	-	7360	7360	9820	9820	9820	9820	-	54000	3930	19.2	17.3
09	09	12	12	12	15	-	-	7040	7040	9390	9390	9390	11740	-	53990	3680	17.9	16.2
09	12	12	12	12	12	-	-	7040	9390	9390	9390	9390	9390	-	53990	3680	17.9	16.2
06	06	06	06	06	06	06	06	6000	6000	6000	6000	6000	6000	6000	42000	4510	22.0	19.9
06	06	06	06	06	06	09	09	6000	6000	6000	6000	6000	6000	9000	45000	5190	25.3	22.9
06	06	06	06	06	06	12	12	6000	6000	6000	6000	6000	6000	12000	48000	5900	28.8	26.0
06	06	06	06	06	06	15	15	6000	6000	6000	6000	6000	6000	15000	51000	5620	27.4	24.8
06	06	06	06	06	06	18	18	6000	6000	6000	6000	6000	6000	18000	54000	5400	26.3	23.8
06	06	06	06	06	06	24	24	5400	5400	5400	5400	5400	5400	21600	54000	4550	22.2	20.1
06	06	06	06	06	09	09	09	6000	6000	6000	6000	6000	9000	9000	48000	5900	28.8	26.0
06	06	06	06	06	09	12	12	6000	6000	6000	6000	6000	9000	12000	51000	5620	27.4	24.8
06	06	06	06	06	09	15	15	6000	6000	6000	6000	6000	9000	15000	54000	5400	26.3	23.8
06	06	06	06	06	09	18	18	5680	5680	5680	5680	5680	8530	17050	53980	4940	24.1	21.8

<Cooling>

Indoor unit combinations							Capacity of each unit (BTU/h)							Total rated capacity (BTU/h)	Outdoor unit Input (W)	Outdoor unit current (A)	
Unit							Unit A	Unit B	Unit C	Unit D	Unit E	Unit F	Unit G			208V	230V
06	06	06	06	06	09	24	5140	5140	5140	5140	5140	7710	20570	53980	4220	20.6	18.6
06	06	06	06	06	12	12	6000	6000	6000	6000	6000	12000	12000	54000	5400	26.3	23.8
06	06	06	06	06	12	15	5680	5680	5680	5680	5680	11370	14210	53980	4940	24.1	21.8
06	06	06	06	06	12	18	5400	5400	5400	5400	5400	10800	16200	54000	4550	22.2	20.1
06	06	06	06	06	12	24	4910	4910	4910	4910	4910	9820	19640	54010	3930	19.2	17.3
06	06	06	06	06	15	15	5400	5400	5400	5400	5400	13500	13500	54000	4550	22.2	20.1
06	06	06	06	06	15	18	5140	5140	5140	5140	5140	12860	15430	53990	4220	20.6	18.6
06	06	06	06	06	15	24	4700	4700	4700	4700	4700	11740	18780	54020	3680	17.9	16.2
06	06	06	06	06	18	18	4910	4910	4910	4910	4910	14730	14730	54010	3930	19.2	17.3
06	06	06	06	09	09	09	6000	6000	6000	6000	9000	9000	9000	51000	5620	27.4	24.8
06	06	06	06	09	09	12	6000	6000	6000	6000	9000	9000	12000	54000	5400	26.3	23.8
06	06	06	06	09	09	15	5680	5680	5680	5680	8530	8530	14210	53990	4940	24.1	21.8
06	06	06	06	09	09	18	5400	5400	5400	5400	8100	8100	16200	54000	4550	22.2	20.1
06	06	06	06	09	09	24	4910	4910	4910	4910	7360	7360	19640	54000	3930	19.2	17.3
06	06	06	06	09	12	12	5680	5680	5680	5680	8530	11370	11370	53990	4940	24.1	21.8
06	06	06	06	09	12	15	5400	5400	5400	5400	8100	10800	13500	54000	4550	22.2	20.1
06	06	06	06	09	12	18	5140	5140	5140	5140	7710	10290	15430	53990	4220	20.6	18.6
06	06	06	06	09	12	24	4700	4700	4700	4700	7040	9390	18780	54010	3680	17.9	16.2
06	06	06	06	09	15	15	5140	5140	5140	5140	7710	12860	12860	53990	4220	20.6	18.6
06	06	06	06	09	15	18	4910	4910	4910	4910	7360	12270	14730	54000	3930	19.2	17.3
06	06	06	06	09	18	18	4700	4700	4700	4700	7040	14090	14090	54020	3680	17.9	16.2
06	06	06	06	12	12	12	5400	5400	5400	5400	10800	10800	10800	54000	4550	22.2	20.1
06	06	06	06	12	12	15	5140	5140	5140	5140	10290	10290	12860	54000	4220	20.6	18.6
06	06	06	06	12	12	18	4910	4910	4910	4910	9820	9820	14730	54010	3930	19.2	17.3
06	06	06	06	12	15	15	4910	4910	4910	4910	9820	12270	12270	54000	3930	19.2	17.3
06	06	06	06	12	15	18	4700	4700	4700	4700	9390	11740	14090	54020	3680	17.9	16.2
06	06	06	06	15	15	15	4700	4700	4700	4700	11740	11740	11740	54020	3680	17.9	16.2
06	06	06	09	09	09	09	6000	6000	6000	9000	9000	9000	9000	54000	5400	26.3	23.8
06	06	06	09	09	09	12	5680	5680	5680	8530	8530	8530	11370	54000	4940	24.1	21.8
06	06	06	09	09	09	15	5400	5400	5400	8100	8100	8100	13500	54000	4550	22.2	20.1
06	06	06	09	09	09	18	5140	5140	5140	7710	7710	7710	15430	53980	4220	20.6	18.6
06	06	06	09	09	09	24	4700	4700	4700	7040	7040	7040	18780	54000	3680	17.9	16.2
06	06	06	09	09	12	12	5400	5400	5400	8100	8100	10800	10800	54000	4550	22.2	20.1
06	06	06	09	09	12	15	5140	5140	5140	7710	7710	10290	12860	53990	4220	20.6	18.6
06	06	06	09	09	12	18	4910	4910	4910	7360	7360	9820	14730	54000	3930	19.2	17.3
06	06	06	09	09	15	15	4910	4910	4910	7360	7360	12270	12270	53990	3930	19.2	17.3
06	06	06	09	09	15	18	4700	4700	4700	7040	7040	11740	14090	54010	3680	17.9	16.2
06	06	06	09	12	12	12	5140	5140	5140	7710	10290	10290	10290	54000	4220	20.6	18.6
06	06	06	09	12	12	15	4910	4910	4910	7360	9820	9820	12270	54000	3930	19.2	17.3
06	06	06	09	12	12	18	4700	4700	4700	7040	9390	9390	14090	54010	3680	17.9	16.2
06	06	06	09	12	12	12	4910	4910	4910	9820	9820	9820	9820	54010	3930	19.2	17.3
06	06	06	12	12	12	15	4700	4700	4700	9390	9390	9390	11740	54010	3680	17.9	16.2
06	06	09	09	09	09	09	5680	5680	8530	8530	8530	8530	8530	54010	4940	24.1	21.8
06	06	09	09	09	09	12	5400	5400	8100	8100	8100	8100	10800	54000	4550	22.2	20.1
06	06	09	09	09	09	15	5140	5140	7710	7710	7710	7710	12860	53980	4220	20.6	18.6
06	06	09	09	09	09	18	4910	4910	7360	7360	7360	7360	14730	53990	3930	19.2	17.3
06	06	09	09	09	12	12	5140	5140	7710	7710	7710	10290	10290	53990	4220	20.6	18.6
06	06	09	09	09	12	15	4910	4910	7360	7360	7360	9820	12270	53990	3930	19.2	17.3
06	06	09	09	09	12	18	4700	4700	7040	7040	7040	9390	14090	54000	3680	17.9	16.2
06	06	09	09	09	15	15	4700	4700	7040	7040	7040	11740	11740	54000	3680	17.9	16.2
06	06	09	09	12	12	12	4910	4910	7360	7360	9820	9820	9820	54000	3930	19.2	17.3
06	06	09	09	12	12	15	4700	4700	7040	7040	9390	9390	11740	54000	3680	17.9	16.2
06	06	09	12	12	12	12	4700	4700	7040	9390	9390	9390	9390	54000	3680	17.9	16.2
06	09	09	09	09	09	09	5400	8100	8100	8100	8100	8100	8100	54000	4550	22.2	20.1
06	09	09	09	09	09	12	5140	7710	7710	7710	7710	7710	10290	53980	4220	20.6	18.6
06	09	09	09	09	09	15	4910	7360	7360	7360	7360	7360	12270	53980	3930	19.2	17.3

<Cooling>

Indoor unit combinations								Capacity of each unit (BTU/h)								Total rated capacity (BTU/h)	Outdoor unit Input (W)	Outdoor unit current (A)		
Unit								Unit A	Unit B	Unit C	Unit D	Unit E	Unit F	Unit G	Unit H			208V	230V	
A	B	C	D	E	F	G	H													
06	09	09	09	09	09	18	-	4700	7040	7040	7040	7040	7040	7040	14090	-	53990	3680	17.9	16.2
06	09	09	09	09	12	12	-	4910	7360	7360	7360	7360	7360	9820	9820	-	53990	3930	19.2	17.3
06	09	09	09	09	12	15	-	4700	7040	7040	7040	7040	7040	9390	11740	-	53990	3680	17.9	16.2
06	09	09	09	12	12	12	-	4700	7040	7040	7040	9390	9390	9390	-	53990	3680	17.9	16.2	
09	09	09	09	09	09	09	-	7710	7710	7710	7710	7710	7710	7710	-	53970	4220	20.6	18.6	
09	09	09	09	09	09	12	-	7360	7360	7360	7360	7360	7360	9820	-	53980	3930	19.2	17.3	
09	09	09	09	09	09	15	-	7040	7040	7040	7040	7040	7040	11740	-	53980	3680	17.9	16.2	
09	09	09	09	09	12	12	-	7040	7040	7040	7040	7040	9390	9390	-	53980	3680	17.9	16.2	
06	06	06	06	06	06	06	06	6000	6000	6000	6000	6000	6000	6000	6000	6000	48000	5900	28.8	26.0
06	06	06	06	06	06	06	09	6000	6000	6000	6000	6000	6000	6000	6000	9000	51000	5620	27.4	24.8
06	06	06	06	06	06	06	12	6000	6000	6000	6000	6000	6000	6000	6000	12000	54000	5400	26.3	23.8
06	06	06	06	06	06	06	15	5680	5680	5680	5680	5680	5680	5680	5680	14210	53970	4930	24.0	21.7
06	06	06	06	06	06	06	18	5400	5400	5400	5400	5400	5400	5400	5400	16200	54000	4550	22.2	20.1
06	06	06	06	06	06	06	24	4910	4910	4910	4910	4910	4910	4910	4910	19640	54010	3930	19.2	17.3
06	06	06	06	06	06	09	09	6000	6000	6000	6000	6000	6000	6000	9000	9000	54000	5400	26.3	23.8
06	06	06	06	06	06	09	12	5680	5680	5680	5680	5680	5680	5680	8530	11370	53980	4940	24.1	21.8
06	06	06	06	06	06	09	15	5400	5400	5400	5400	5400	5400	5400	8100	13500	54000	4550	22.2	20.1
06	06	06	06	06	06	09	18	5140	5140	5140	5140	5140	5140	5140	7710	15430	53980	4220	20.6	18.6
06	06	06	06	06	06	09	24	4700	4700	4700	4700	4700	4700	4700	7040	18780	54020	3680	17.9	16.2
06	06	06	06	06	06	12	12	5400	5400	5400	5400	5400	5400	5400	10800	10800	54000	4550	22.2	20.1
06	06	06	06	06	06	12	15	5140	5140	5140	5140	5140	5140	5140	10290	12860	53990	4220	20.6	18.6
06	06	06	06	06	06	12	18	4910	4910	4910	4910	4910	4910	4910	9820	14730	54010	3930	19.2	17.3
06	06	06	06	06	06	15	15	4910	4910	4910	4910	4910	4910	4910	12270	12270	54000	3930	19.2	17.3
06	06	06	06	06	06	15	18	4700	4700	4700	4700	4700	4700	4700	11740	14090	54030	3680	17.9	16.2
06	06	06	06	06	09	09	09	5680	5680	5680	5680	5680	5680	8530	8530	8530	53990	4940	24.1	21.8
06	06	06	06	06	09	09	12	5400	5400	5400	5400	5400	5400	8100	8100	10800	54000	4550	22.2	20.1
06	06	06	06	06	09	09	15	5140	5140	5140	5140	5140	5140	7710	7710	12860	53980	4220	20.6	18.6
06	06	06	06	06	09	09	18	4910	4910	4910	4910	4910	4910	7360	7360	14730	54000	3930	19.2	17.3
06	06	06	06	06	09	12	12	5140	5140	5140	5140	5140	5140	7710	10290	10290	53990	4220	20.6	18.6
06	06	06	06	06	09	12	15	4910	4910	4910	4910	4910	4910	7360	9820	12270	54000	3930	19.2	17.3
06	06	06	06	06	09	12	18	4700	4700	4700	4700	4700	4700	7040	9390	14090	54020	3680	17.9	16.2
06	06	06	06	06	09	15	15	4700	4700	4700	4700	4700	4700	7040	11740	11740	54020	3680	17.9	16.2
06	06	06	06	06	12	12	12	4910	4910	4910	4910	4910	4910	9820	9820	9820	54010	3930	19.2	17.3
06	06	06	06	06	12	12	15	4700	4700	4700	4700	4700	4700	9390	9390	11740	54020	3680	17.9	16.2
06	06	06	06	09	09	09	09	5400	5400	5400	5400	5400	8100	8100	8100	8100	54000	4550	22.2	20.1
06	06	06	06	09	09	09	12	5140	5140	5140	5140	5140	7710	7710	7710	10290	53980	4220	20.6	18.6
06	06	06	06	09	09	09	15	4910	4910	4910	4910	4910	7360	7360	7360	12270	53990	3930	19.2	17.3
06	06	06	06	09	09	09	18	4700	4700	4700	4700	4700	7040	7040	7040	14090	54010	3680	17.9	16.2
06	06	06	06	09	09	12	12	4910	4910	4910	4910	4910	7360	7360	9820	9820	54000	3930	19.2	17.3
06	06	06	06	09	09	12	15	4700	4700	4700	4700	4700	7040	7040	9390	11740	54010	3680	17.9	16.2
06	06	06	06	09	09	12	12	4700	4700	4700	4700	7040	9390	9390	9390	54010	3680	17.9	16.2	
06	06	06	09	09	09	09	09	5140	5140	5140	7710	7710	7710	7710	7710	53970	4220	20.6	18.6	
06	06	06	09	09	09	09	12	4910	4910	4910	7360	7360	7360	7360	9820	53990	3930	19.2	17.3	
06	06	06	09	09	09	09	15	4700	4700	4700	7040	7040	7040	7040	11740	54000	3680	17.9	16.2	
06	06	06	09	09	09	12	12	4700	4700	4700	7040	7040	7040	9390	9390	54000	3680	17.9	16.2	
06	06	09	09	09	09	09	09	4910	4910	7360	7360	7360	7360	7360	7360	53980	3930	19.2	17.3	
06	06	09	09	09	09	12	12	4700	4700	7040	7040	7040	7040	7040	9390	53990	3680	17.9	16.2	
06	09	09	09	09	09	09	09	4700	7040	7040	7040	7040	7040	7040	7040	53980	3680	17.9	16.2	

(2) Heating mode**<Heating>**

Indoor unit combinations			Capacity of each unit (BTU/h)			Total rated capacity (BTU/h)	Outdoor unit input (W)	Outdoor unit current (A)	
Unit A	Unit B	Unit C	Unit A	Unit B	Unit C			208V	230V
06	-	-	7200	-	-	7200	720	3.5	3.2
09	-	-	10900	-	-	10900	1100	5.4	4.9
12	-	-	14400	-	-	14400	1450	7.1	6.4
15	-	-	18000	-	-	18000	1810	8.8	8.0
18	-	-	21600	-	-	21600	2180	10.7	9.6
24	-	-	28800	-	-	28800	2960	14.5	13.1
06	06	-	7200	7200	-	14400	1450	7.1	6.4
06	09	-	7200	10900	-	18100	1820	8.9	8.0
06	12	-	7200	14400	-	21600	2180	10.7	9.6
06	15	-	7200	18000	-	25200	2570	12.6	11.4
06	18	-	7200	21600	-	28800	2960	14.5	13.1
06	24	-	7200	28800	-	36000	3770	18.4	16.7
09	09	-	10900	10900	-	21800	2200	10.7	9.7
09	12	-	10900	14400	-	25300	2580	12.6	11.4
09	15	-	10900	18000	-	28900	2970	14.5	13.1
09	18	-	10900	21600	-	32500	3370	16.5	14.9
09	24	-	10900	28800	-	39700	4190	20.5	18.5
12	12	-	14400	14400	-	28800	2960	14.5	13.1
12	15	-	14400	18000	-	32400	3360	16.4	14.8
12	18	-	14400	21600	-	36000	3770	18.4	16.7
12	24	-	14400	28800	-	43200	4480	21.9	19.8
15	15	-	18000	18000	-	36000	3770	18.4	16.7
15	18	-	18000	21600	-	39600	4180	20.4	18.5
15	24	-	18000	28800	-	46800	4680	22.9	20.7
18	18	-	21600	21600	-	43200	4480	21.9	19.8
18	24	-	21600	28800	-	50400	4870	23.8	21.5
24	24	-	28800	28800	-	57600	5210	25.5	23.0
06	06	06	7200	7200	7200	21600	2180	10.7	9.6
06	06	09	7200	7200	10900	25300	2580	12.6	11.4
06	06	12	7200	7200	14400	28800	2960	14.5	13.1
06	06	15	7200	7200	18000	32400	3360	16.4	14.8
06	06	18	7200	7200	21600	36000	3770	18.4	16.7
06	06	24	7200	7200	28800	43200	4480	21.9	19.8
06	09	09	7200	10900	10900	29000	2980	14.6	13.2
06	09	12	7200	10900	14400	32500	3370	16.5	14.9
06	09	15	7200	10900	18000	36100	3780	18.5	16.7
06	09	18	7200	10900	21600	39700	4190	20.5	18.5
06	09	24	7200	10900	28800	46900	4690	22.9	20.7
06	12	12	7200	14400	14400	36000	3770	18.4	16.7
06	12	15	7200	14400	18000	39600	4180	20.4	18.5
06	12	18	7200	14400	21600	43200	4480	21.9	19.8
06	12	24	7200	14400	28800	50400	4870	23.8	21.5
06	15	15	7200	18000	18000	43200	4480	21.9	19.8
06	15	18	7200	18000	21600	46800	4680	22.9	20.7
06	15	24	7200	18000	28800	54000	5050	24.7	22.3
06	18	18	7200	21600	21600	50400	4870	23.8	21.5
06	18	24	7200	21600	28800	57600	5210	25.5	23.0
06	24	24	6670	26670	26670	60010	4850	23.7	21.4

<Heating>

Indoor unit combinations				Capacity of each unit (BTU/h)				Total rated capacity (BTU/h)	Outdoor unit input (W)	Outdoor unit current (A)	
Unit A	Unit B	Unit C	Unit D	Unit A	Unit B	Unit C	Unit D			208V	230V
09	09	09	-	10900	10900	10900	-	32700	3390	16.6	15.0
09	09	12	-	10900	10900	14400	-	36200	3790	18.5	16.7
09	09	15	-	10900	10900	18000	-	39800	4200	20.5	18.6
09	09	18	-	10900	10900	21600	-	43400	4500	22.0	19.9
09	09	24	-	10900	10900	28800	-	50600	4890	23.9	21.6
09	12	12	-	10900	14400	14400	-	39700	4190	20.5	18.5
09	12	15	-	10900	14400	18000	-	43300	4490	21.9	19.8
09	12	18	-	10900	14400	21600	-	46900	4690	22.9	20.7
09	12	24	-	10900	14400	28800	-	54100	5060	24.7	22.4
09	15	15	-	10900	18000	18000	-	46900	4690	22.9	20.7
09	15	18	-	10900	18000	21600	-	50500	4880	23.8	21.6
09	15	24	-	10900	18000	28800	-	57700	5220	25.5	23.1
09	18	18	-	10900	21600	21600	-	54100	5060	24.7	22.4
09	18	24	-	10670	21140	28190	-	60000	5120	25.0	22.6
09	24	24	-	9550	25230	25230	-	60010	4610	22.5	20.4
12	12	12	-	14400	14400	14400	-	43200	4480	21.9	19.8
12	12	15	-	14400	14400	18000	-	46800	4680	22.9	20.7
12	12	18	-	14400	14400	21600	-	50400	4870	23.8	21.5
12	12	24	-	14400	14400	28800	-	57600	5210	25.5	23.0
12	15	15	-	14400	18000	18000	-	50400	4870	23.8	21.5
12	15	18	-	14400	18000	21600	-	54000	5050	24.7	22.3
12	15	24	-	14120	17650	28240	-	60010	5120	25.0	22.6
12	18	18	-	14400	21600	21600	-	57600	5210	25.5	23.0
12	18	24	-	13330	20000	26670	-	60000	4850	23.7	21.4
12	24	24	-	12000	24000	24000	-	60000	4390	21.4	19.4
15	15	15	-	18000	18000	18000	-	54000	5050	24.7	22.3
15	15	18	-	18000	18000	21600	-	57600	5210	25.5	23.0
15	15	24	-	16670	16670	26670	-	60010	4850	23.7	21.4
15	18	18	-	17650	21180	21180	-	60010	5120	25.0	22.6
15	18	24	-	15790	18950	25260	-	60000	4610	22.5	20.4
15	24	24	-	14290	22860	22860	-	60010	4190	20.5	18.5
18	18	18	-	20000	20000	20000	-	60000	4850	23.7	21.4
18	18	24	-	18000	18000	24000	-	60000	4390	21.4	19.4
18	24	24	-	16360	21820	21820	-	60000	4010	19.6	17.7
06	06	06	06	7200	7200	7200	7200	28800	2960	14.5	13.1
06	06	06	09	7200	7200	7200	10900	32500	3370	16.5	14.9
06	06	06	12	7200	7200	7200	14400	36000	3770	18.4	16.7
06	06	06	15	7200	7200	7200	18000	39600	4180	20.4	18.5
06	06	06	18	7200	7200	7200	21600	43200	4480	21.9	19.8
06	06	06	24	7200	7200	7200	28800	50400	4870	23.8	21.5
06	06	09	09	7200	7200	10900	10900	36200	3790	18.5	16.7
06	06	09	12	7200	7200	10900	14400	39700	4190	20.5	18.5
06	06	09	15	7200	7200	10900	18000	43300	4490	21.9	19.8
06	06	09	18	7200	7200	10900	21600	46900	4690	22.9	20.7
06	06	09	24	7200	7200	10900	28800	54100	5060	24.7	22.4
06	06	12	12	7200	7200	14400	14400	43200	4480	21.9	19.8
06	06	12	15	7200	7200	14400	18000	46800	4680	22.9	20.7
06	06	12	18	7200	7200	14400	21600	50400	4870	23.8	21.5
06	06	12	24	7200	7200	14400	28800	57600	5210	25.5	23.0
06	06	15	15	7200	7200	18000	18000	50400	4870	23.8	21.5
06	06	15	18	7200	7200	18000	21600	54000	5050	24.7	22.3
06	06	15	24	7060	7060	17650	28240	60010	5120	25.0	22.6
06	06	18	18	7200	7200	21600	21600	57600	5210	25.5	23.0
06	06	18	24	6670	6670	20000	26670	60010	4850	23.7	21.4
06	06	24	24	6000	6000	24000	24000	60000	4390	21.4	19.4

<Heating>

Indoor unit combinations				Capacity of each unit (BTU/h)				Total rated capacity (BTU/h)	Outdoor unit input (W)	Outdoor unit current (A)	
Unit A	Unit B	Unit C	Unit D	Unit A	Unit B	Unit C	Unit D			208V	230V
06	09	09	09	7200	10900	10900	10900	39900	4210	20.6	18.6
06	09	09	12	7200	10900	10900	14400	43400	4500	22.0	19.9
06	09	09	15	7200	10900	10900	18000	47000	4700	23.0	20.8
06	09	09	18	7200	10900	10900	21600	50600	4890	23.9	21.6
06	09	09	24	7200	10900	10900	28800	57800	5230	25.6	23.1
06	09	12	12	7200	10900	14400	14400	46900	4690	22.9	20.7
06	09	12	15	7200	10900	14400	18000	50500	4880	23.8	21.6
06	09	12	18	7200	10900	14400	21600	54100	5060	24.7	22.4
06	09	12	24	7050	10670	14090	28190	60000	5120	25.0	22.6
06	09	15	15	7200	10900	18000	18000	54100	5060	24.7	22.4
06	09	15	18	7200	10900	18000	21600	57700	5220	25.5	23.1
06	09	15	24	6660	10080	16640	26630	60010	4850	23.7	21.4
06	09	18	18	7050	10670	21140	21140	60000	5120	25.0	22.6
06	09	18	24	6310	9550	18920	25230	60010	4610	22.5	20.4
06	09	24	24	5710	8640	22830	22830	60010	4190	20.5	18.5
06	12	12	12	7200	14400	14400	14400	50400	4870	23.8	21.5
06	12	12	15	7200	14400	14400	18000	54000	5050	24.7	22.3
06	12	12	18	7200	14400	14400	21600	57600	5210	25.5	23.0
06	12	12	24	6670	13330	13330	26670	60000	4850	23.7	21.4
06	12	15	15	7200	14400	18000	18000	57600	5210	25.5	23.0
06	12	15	18	7060	14120	17650	21180	60010	5120	25.0	22.6
06	12	15	24	6320	12630	15790	25260	60000	4610	22.5	20.4
06	12	18	18	6670	13330	20000	20000	60000	4850	23.7	21.4
06	12	18	24	6000	12000	18000	24000	60000	4390	21.4	19.4
06	12	24	24	5450	10910	21820	21820	60000	4010	19.6	17.7
06	15	15	15	7060	17650	17650	17650	60010	5120	25.0	22.6
06	15	15	18	6670	16670	16670	20000	60010	4850	23.7	21.4
06	15	15	24	6000	15000	15000	24000	60000	4390	21.4	19.4
06	15	18	18	6320	15790	18950	18950	60010	4610	22.5	20.4
06	15	18	24	5710	14290	17140	22860	60000	4190	20.5	18.5
06	15	24	24	5220	13040	20870	20870	60000	3840	18.8	17.0
06	18	18	18	6000	18000	18000	18000	60000	4390	21.4	19.4
06	18	18	24	5450	16360	16360	21820	59990	4010	19.6	17.7
09	09	09	09	10900	10900	10900	10900	43600	4520	22.1	20.0
09	09	09	12	10900	10900	10900	14400	47100	4710	23.0	20.8
09	09	09	15	10900	10900	10900	18000	50700	4900	23.9	21.7
09	09	09	18	10900	10900	10900	21600	54300	5080	24.8	22.4
09	09	09	24	10630	10630	10630	28100	59990	5120	25.0	22.6
09	09	12	12	10900	10900	14400	14400	50600	4890	23.9	21.6
09	09	12	15	10900	10900	14400	18000	54200	5070	24.8	22.4
09	09	12	18	10900	10900	14400	21600	57800	5230	25.6	23.1
09	09	12	24	10060	10060	13290	26580	59990	4850	23.7	21.4
09	09	15	15	10900	10900	18000	18000	57800	5230	25.6	23.1
09	09	15	18	10650	10650	17590	21110	60000	5120	25.0	22.6
09	09	15	24	9530	9530	15740	25190	59990	4610	22.5	20.4
09	09	18	18	10060	10060	19940	19940	60000	4850	23.7	21.4
09	09	18	24	9060	9060	17950	23930	60000	4390	21.4	19.4
09	09	24	24	8240	8240	21760	21760	60000	4010	19.6	17.7
09	12	12	12	10900	14400	14400	14400	54100	5060	24.7	22.4
09	12	12	15	10900	14400	14400	18000	57700	5220	25.5	23.1
09	12	12	18	10670	14090	14090	21140	59990	5120	25.0	22.6
09	12	12	24	9550	12610	12610	25230	60000	4610	22.5	20.4
09	12	15	15	10670	14090	17620	17620	60000	5120	25.0	22.6
09	12	15	18	10080	13310	16640	19970	60000	4850	23.7	21.4
09	12	15	24	9070	11980	14980	23970	60000	4390	21.4	19.4
09	12	18	18	9550	12610	18920	18920	60000	4610	22.5	20.4
09	12	18	24	8640	11410	17120	22830	60000	4190	20.5	18.5

<Heating>

Indoor unit combinations					Capacity of each unit (BTU/h)					Total rated capacity (BTU/h)	Outdoor unit input (W)	Outdoor unit current (A)	
Unit A	Unit B	Unit C	Unit D	Unit E	Unit A	Unit B	Unit C	Unit D	Unit E			208V	230V
09	12	24	24	-	7890	10420	20840	20840	-	59990	3840	18.8	17.0
09	15	15	15	-	10080	16640	16640	16640	-	60000	4850	23.7	21.4
09	15	15	18	-	9550	15770	15770	18920	-	60010	4610	22.5	20.4
09	15	15	24	-	8640	14270	14270	22830	-	60010	4190	20.5	18.5
09	15	18	18	-	9070	14980	17980	17980	-	60010	4390	21.4	19.4
09	15	18	24	-	8250	13620	16340	21790	-	60000	4010	19.6	17.7
09	18	18	18	-	8640	17120	17120	17120	-	60000	4190	20.5	18.5
09	18	18	24	-	7890	15630	15630	20840	-	59990	3840	18.8	17.0
12	12	12	12	-	14400	14400	14400	14400	-	57600	5210	25.5	23.0
12	12	12	15	-	14120	14120	14120	17650	-	60010	5120	25.0	22.6
12	12	12	18	-	13330	13330	13330	20000	-	59990	4850	23.7	21.4
12	12	12	24	-	12000	12000	12000	24000	-	60000	4390	21.4	19.4
12	12	15	15	-	13330	13330	16670	16670	-	60000	4850	23.7	21.4
12	12	15	18	-	12630	12630	15790	18950	-	60000	4610	22.5	20.4
12	12	15	24	-	11430	11430	14290	22860	-	60010	4190	20.5	18.5
12	12	18	18	-	12000	12000	18000	18000	-	60000	4390	21.4	19.4
12	12	18	24	-	10910	10910	16360	21820	-	60000	4010	19.6	17.7
12	15	15	15	-	12630	15790	15790	15790	-	60000	4610	22.5	20.4
12	15	15	18	-	12000	15000	15000	18000	-	60000	4390	21.4	19.4
12	15	15	24	-	10910	13640	13640	21820	-	60010	4010	19.6	17.7
12	15	18	18	-	11430	14290	17140	17140	-	60000	4190	20.5	18.5
12	15	18	24	-	10430	13040	15650	20870	-	59990	3840	18.8	17.0
12	18	18	18	-	10910	16360	16360	16360	-	59990	4010	19.6	17.7
15	15	15	15	-	15000	15000	15000	15000	-	60000	4390	21.4	19.4
15	15	15	18	-	14290	14290	14290	17140	-	60010	4190	20.5	18.5
15	15	15	24	-	13040	13040	13040	20870	-	59990	3840	18.8	17.0
15	15	18	18	-	13640	13640	16360	16360	-	60000	4010	19.6	17.7
15	18	18	18	-	13040	15650	15650	15650	-	59990	3840	18.8	17.0
06	06	06	06	06	7200	7200	7200	7200	7200	36000	3770	18.4	16.7
06	06	06	06	09	7200	7200	7200	7200	10900	39700	4190	20.5	18.5
06	06	06	06	12	7200	7200	7200	7200	14400	43200	4480	21.9	19.8
06	06	06	06	15	7200	7200	7200	7200	18000	46800	4680	22.9	20.7
06	06	06	06	18	7200	7200	7200	7200	21600	50400	4870	23.8	21.5
06	06	06	06	24	7200	7200	7200	7200	28800	57600	5210	25.5	23.0
06	06	06	09	09	7200	7200	7200	10900	10900	43400	4500	22.0	19.9
06	06	06	09	12	7200	7200	7200	10900	14400	46900	4690	22.9	20.7
06	06	06	09	15	7200	7200	7200	10900	18000	50500	4880	23.8	21.6
06	06	06	09	18	7200	7200	7200	10900	21600	54100	5060	24.7	22.4
06	06	06	09	24	7050	7050	7050	10670	28190	60010	5120	25.0	22.6
06	06	06	12	12	7200	7200	7200	14400	14400	50400	4870	23.8	21.5
06	06	06	12	15	7200	7200	7200	14400	18000	54000	5050	24.7	22.3
06	06	06	12	18	7200	7200	7200	14400	21600	57600	5210	25.5	23.0
06	06	06	12	24	6670	6670	6670	13330	26670	60010	4850	23.7	21.4
06	06	06	15	15	7200	7200	7200	18000	18000	57600	5210	25.5	23.0
06	06	06	15	18	7060	7060	7060	17650	21180	60010	5120	25.0	22.6
06	06	06	15	24	6320	6320	6320	15790	25260	60010	4610	22.5	20.4
06	06	06	18	18	6670	6670	6670	20000	20000	60010	4850	23.7	21.4
06	06	06	18	24	6000	6000	6000	18000	24000	60000	4390	21.4	19.4
06	06	06	24	24	5450	5450	5450	21820	21820	59990	4010	19.6	17.7
06	06	09	09	09	7200	7200	10900	10900	10900	47100	4710	23.0	20.8
06	06	09	09	12	7200	7200	10900	10900	14400	50600	4890	23.9	21.6
06	06	09	09	15	7200	7200	10900	10900	18000	54200	5070	24.8	22.4
06	06	09	09	18	7200	7200	10900	10900	21600	57800	5230	25.6	23.1
06	06	09	09	24	6650	6650	10060	10060	26580	60000	4850	23.7	21.4
06	06	09	12	12	7200	7200	10900	14400	14400	54100	5060	24.7	22.4
06	06	09	12	15	7200	7200	10900	14400	18000	57700	5220	25.5	23.1
06	06	09	12	18	7050	7050	10670	14090	21140	60000	5120	25.0	22.6

<Heating>

Indoor unit combinations					Capacity of each unit (BTU/h)					Total rated capacity (BTU/h)	Outdoor unit input (W)	Outdoor unit current (A)	
Unit					Unit A	Unit B	Unit C	Unit D	Unit E			208V	230V
A	B	C	D	E									
06	06	09	12	24	6310	6310	9550	12610	25230	60010	4610	22.5	20.4
06	06	09	15	15	7050	7050	10670	17620	17620	60010	5120	25.0	22.6
06	06	09	15	18	6660	6660	10080	16640	19970	60010	4850	23.7	21.4
06	06	09	15	24	5990	5990	9070	14980	23970	60000	4390	21.4	19.4
06	06	09	18	18	6310	6310	9550	18920	18920	60010	4610	22.5	20.4
06	06	09	18	24	5710	5710	8640	17120	22830	60010	4190	20.5	18.5
06	06	09	24	24	5210	5210	7890	20840	20840	59990	3840	18.8	17.0
06	06	12	12	12	7200	7200	14400	14400	14400	57600	5210	25.5	23.0
06	06	12	12	15	7060	7060	14120	14120	17650	60010	5120	25.0	22.6
06	06	12	12	18	6670	6670	13330	13330	20000	60000	4850	23.7	21.4
06	06	12	12	24	6000	6000	12000	12000	24000	60000	4390	21.4	19.4
06	06	12	15	15	6670	6670	13330	16670	16670	60010	4850	23.7	21.4
06	06	12	15	18	6320	6320	12630	15790	18950	60010	4610	22.5	20.4
06	06	12	15	24	5710	5710	11430	14290	22860	60000	4190	20.5	18.5
06	06	12	18	18	6000	6000	12000	18000	18000	60000	4390	21.4	19.4
06	06	12	18	24	5450	5450	10910	16360	21820	59990	4010	19.6	17.7
06	06	15	15	15	6320	6320	15790	15790	15790	60010	4610	22.5	20.4
06	06	15	15	18	6000	6000	15000	15000	18000	60000	4390	21.4	19.4
06	06	15	15	24	5450	5450	13640	13640	21820	60000	4010	19.6	17.7
06	06	15	18	18	5710	5710	14290	17140	17140	59990	4190	20.5	18.5
06	06	15	18	24	5220	5220	13040	15650	20870	60000	3840	18.8	17.0
06	06	18	18	18	5450	5450	16360	16360	16360	59980	4010	19.6	17.7
06	09	09	09	09	7200	10900	10900	10900	10900	50800	4910	24.0	21.7
06	09	09	09	12	7200	10900	10900	10900	14400	54300	5080	24.8	22.4
06	09	09	09	15	7200	10900	10900	10900	18000	57900	5230	25.6	23.1
06	09	09	09	18	7020	10630	10630	10630	21070	59980	5120	25.0	22.6
06	09	09	09	24	6290	9520	9520	9520	25150	60000	4610	22.5	20.4
06	09	09	12	12	7200	10900	10900	14400	14400	57800	5230	25.6	23.1
06	09	09	12	15	7040	10650	10650	14070	17590	60000	5120	25.0	22.6
06	09	09	12	18	6650	10060	10060	13290	19940	60000	4850	23.7	21.4
06	09	09	12	24	5980	9060	9060	11970	23930	60000	4390	21.4	19.4
06	09	09	15	15	6650	10060	10060	16620	16620	60010	4850	23.7	21.4
06	09	09	15	18	6300	9530	9530	15740	18890	59990	4610	22.5	20.4
06	09	09	15	24	5700	8630	8630	14250	22800	60010	4190	20.5	18.5
06	09	09	18	18	5980	9060	9060	17950	17950	60000	4390	21.4	19.4
06	09	09	18	24	5440	8240	8240	16320	21760	60000	4010	19.6	17.7
06	09	12	12	12	7050	10670	14090	14090	14090	59990	5120	25.0	22.6
06	09	12	12	15	6660	10080	13310	13310	16640	60000	4850	23.7	21.4
06	09	12	12	18	6310	9550	12610	12610	18920	60000	4610	22.5	20.4
06	09	12	12	24	5710	8640	11410	11410	22830	60000	4190	20.5	18.5
06	09	12	15	15	6310	9550	12610	15770	15770	60010	4610	22.5	20.4
06	09	12	15	18	5990	9070	11980	14980	17980	60000	4390	21.4	19.4
06	09	12	15	24	5450	8250	10900	13620	21790	60010	4010	19.6	17.7
06	09	12	18	18	5710	8640	11410	17120	17120	60000	4190	20.5	18.5
06	09	12	18	24	5210	7890	10420	15630	20840	59990	3840	18.8	17.0
06	09	15	15	15	5990	9070	14980	14980	14980	60000	4390	21.4	19.4
06	09	15	15	18	5710	8640	14270	14270	17120	60010	4190	20.5	18.5
06	09	15	15	24	5210	7890	13030	13030	20840	60000	3840	18.8	17.0
06	09	15	18	18	5450	8250	13620	16340	16340	60000	4010	19.6	17.7
06	09	18	18	18	5210	7890	15630	15630	15630	59990	3840	18.8	17.0
06	12	12	12	12	6670	13330	13330	13330	13330	59990	4850	23.7	21.4
06	12	12	12	15	6320	12630	12630	12630	15790	60000	4610	22.5	20.4
06	12	12	12	18	6000	12000	12000	12000	18000	60000	4390	21.4	19.4
06	12	12	12	24	5450	10910	10910	10910	21820	60000	4010	19.6	17.7
06	12	12	15	15	6000	12000	12000	15000	15000	60000	4390	21.4	19.4
06	12	12	15	18	5710	11430	11430	14290	17140	60000	4190	20.5	18.5
06	12	12	15	24	5220	10430	10430	13040	20870	59990	3840	18.8	17.0

<Heating>

Indoor unit combinations						Capacity of each unit (BTU/h)						Total rated capacity (BTU/h)	Outdoor unit input (W)	Outdoor unit current (A)	
Unit						Unit A	Unit B	Unit C	Unit D	Unit E	Unit F			208V	230V
A	B	C	D	E	F										
06	12	12	18	18	-	5450	10910	10910	16360	16360	-	59990	4010	19.6	17.7
06	12	15	15	15	-	5710	11430	14290	14290	14290	-	60010	4190	20.5	18.5
06	12	15	15	18	-	5450	10910	13640	13640	16360	-	60000	4010	19.6	17.7
06	12	15	18	18	-	5220	10430	13040	15650	15650	-	59990	3840	18.8	17.0
06	15	15	15	15	-	5450	13640	13640	13640	13640	-	60010	4010	19.6	17.7
06	15	15	15	18	-	5220	13040	13040	13040	15650	-	59990	3840	18.8	17.0
09	09	09	09	09	-	10900	10900	10900	10900	10900	-	54500	5100	24.9	22.5
09	09	09	09	12	-	10900	10900	10900	10900	14400	-	58000	5240	25.6	23.2
09	09	09	09	15	-	10620	10620	10620	10620	17530	-	60010	5120	25.0	22.6
09	09	09	09	18	-	10030	10030	10030	10030	19880	-	60000	4850	23.7	21.4
09	09	09	09	24	-	9030	9030	9030	9030	23870	-	59990	4390	21.4	19.4
09	09	09	12	12	-	10630	10630	10630	14050	14050	-	59990	5120	25.0	22.6
09	09	09	12	15	-	10050	10050	10050	13270	16590	-	60010	4850	23.7	21.4
09	09	09	12	18	-	9520	9520	9520	12580	18860	-	60000	4610	22.5	20.4
09	09	09	12	24	-	8620	8620	8620	11380	22770	-	60010	4190	20.5	18.5
09	09	09	15	15	-	9520	9520	9520	15720	15720	-	60000	4610	22.5	20.4
09	09	09	15	18	-	9050	9050	9050	14940	17930	-	60020	4390	21.4	19.4
09	09	09	15	24	-	8230	8230	8230	13580	21740	-	60010	4010	19.6	17.7
09	09	09	18	18	-	8620	8620	8620	17080	17080	-	60020	4190	20.5	18.5
09	09	09	18	24	-	7870	7870	7870	15600	20790	-	60000	3840	18.8	17.0
09	09	12	12	12	-	10060	10060	13290	13290	13290	-	59990	4850	23.7	21.4
09	09	12	12	15	-	9530	9530	12590	12590	15740	-	59980	4610	22.5	20.4
09	09	12	12	18	-	9060	9060	11970	11970	17950	-	60010	4390	21.4	19.4
09	09	12	12	24	-	8240	8240	10880	10880	21760	-	60000	4010	19.6	17.7
09	09	12	15	15	-	9060	9060	11970	14960	14960	-	60010	4390	21.4	19.4
09	09	12	15	18	-	8630	8630	11400	14250	17100	-	60010	4190	20.5	18.5
09	09	12	15	24	-	7880	7880	10410	13010	20820	-	60000	3840	18.8	17.0
09	09	12	18	18	-	8240	8240	10880	16320	16320	-	60000	4010	19.6	17.7
09	09	15	15	15	-	8630	8630	14250	14250	14250	-	60010	4190	20.5	18.5
09	09	15	15	18	-	8240	8240	13600	13600	16320	-	60000	4010	19.6	17.7
09	09	15	18	18	-	7880	7880	13010	15610	15610	-	59990	3840	18.8	17.0
09	12	12	12	12	-	9550	12610	12610	12610	12610	-	59990	4610	22.5	20.4
09	12	12	12	15	-	9070	11980	11980	11980	14980	-	59990	4390	21.4	19.4
09	12	12	12	18	-	8640	11410	11410	11410	17120	-	59990	4190	20.5	18.5
09	12	12	12	24	-	7890	10420	10420	10420	20840	-	59990	3840	18.8	17.0
09	12	12	15	15	-	8640	11410	11410	14270	14270	-	60000	4190	20.5	18.5
09	12	12	15	18	-	8250	10900	10900	13620	16340	-	60010	4010	19.6	17.7
09	12	12	18	18	-	7890	10420	10420	15630	15630	-	59990	3840	18.8	17.0
09	12	15	15	15	-	8250	10900	13620	13620	13620	-	60010	4010	19.6	17.7
09	12	15	15	18	-	7890	10420	13030	13030	15630	-	60000	3840	18.8	17.0
09	15	15	15	15	-	7890	13030	13030	13030	13030	-	60010	3840	18.8	17.0
12	12	12	12	12	-	12000	12000	12000	12000	12000	-	60000	4390	21.4	19.4
12	12	12	12	15	-	11430	11430	11430	11430	14290	-	60010	4190	20.5	18.5
12	12	12	12	18	-	10910	10910	10910	10910	16360	-	60000	4010	19.6	17.7
12	12	12	15	15	-	10910	10910	10910	13640	13640	-	60010	4010	19.6	17.7
12	12	12	15	18	-	10430	10430	10430	13040	15650	-	59980	3840	18.8	17.0
12	12	15	15	15	-	10430	10430	13040	13040	13040	-	59980	3840	18.8	17.0
06	06	06	06	06	06	7200	7200	7200	7200	7200	7200	43200	4480	21.9	19.8
06	06	06	06	06	09	7200	7200	7200	7200	7200	10900	46900	4690	22.9	20.7
06	06	06	06	06	12	7200	7200	7200	7200	7200	14400	50400	4870	23.8	21.5
06	06	06	06	06	15	7200	7200	7200	7200	7200	18000	54000	5050	24.7	22.3
06	06	06	06	06	18	7200	7200	7200	7200	7200	21600	57600	5210	25.5	23.0
06	06	06	06	06	24	6670	6670	6670	6670	6670	26670	60020	4850	23.7	21.4
06	06	06	06	09	09	7200	7200	7200	7200	10900	10900	50600	4890	23.9	21.6
06	06	06	06	09	12	7200	7200	7200	7200	10900	14400	54100	5060	24.7	22.4
06	06	06	06	09	15	7200	7200	7200	7200	10900	18000	57700	5220	25.5	23.1
06	06	06	06	09	18	7050	7050	7050	7050	10670	21140	60010	5120	25.0	22.6

<Heating>

Indoor unit combinations						Capacity of each unit (BTU/h)						Total rated capacity (BTU/h)	Outdoor unit input (W)	Outdoor unit current (A)	
Unit						Unit A	Unit B	Unit C	Unit D	Unit E	Unit F			208V	230V
06	06	06	06	09	24	6310	6310	6310	6310	9550	25230	60020	4610	22.5	20.4
06	06	06	06	12	12	7200	7200	7200	7200	14400	14400	57600	5210	25.5	23.0
06	06	06	06	12	15	7060	7060	7060	7060	14120	17650	60010	5120	25.0	22.6
06	06	06	06	12	18	6670	6670	6670	6670	13330	20000	60010	4850	23.7	21.4
06	06	06	06	12	24	6000	6000	6000	6000	12000	24000	60000	4390	21.4	19.4
06	06	06	06	15	15	6670	6670	6670	6670	16670	16670	60020	4850	23.7	21.4
06	06	06	06	15	18	6320	6320	6320	6320	15790	18950	60020	4610	22.5	20.4
06	06	06	06	15	24	5710	5710	5710	5710	14290	22860	59990	4190	20.5	18.5
06	06	06	06	18	18	6000	6000	6000	6000	18000	18000	60000	4390	21.4	19.4
06	06	06	06	18	24	5450	5450	5450	5450	16360	21820	59980	4010	19.6	17.7
06	06	06	09	09	09	7200	7200	7200	10900	10900	10900	54300	5080	24.8	22.4
06	06	06	09	09	12	7200	7200	7200	10900	10900	14400	57800	5230	25.6	23.1
06	06	06	09	09	15	7040	7040	7040	10650	10650	17590	60010	5120	25.0	22.6
06	06	06	09	09	18	6650	6650	6650	10060	10060	19940	60010	4850	23.7	21.4
06	06	06	09	09	24	5980	5980	5980	9060	9060	23930	59990	4390	21.4	19.4
06	06	06	09	12	12	7050	7050	7050	10670	14090	14090	60000	5120	25.0	22.6
06	06	06	09	12	15	6660	6660	6660	10080	13310	16640	60010	4850	23.7	21.4
06	06	06	09	12	18	6310	6310	6310	9550	12610	18920	60010	4610	22.5	20.4
06	06	06	09	12	24	5710	5710	5710	8640	11410	22830	60010	4190	20.5	18.5
06	06	06	09	15	15	6310	6310	6310	9550	15770	15770	60020	4610	22.5	20.4
06	06	06	09	15	18	5990	5990	5990	9070	14980	17980	60000	4390	21.4	19.4
06	06	06	09	15	24	5450	5450	5450	8250	13620	21790	60010	4010	19.6	17.7
06	06	06	09	18	18	5710	5710	5710	8640	17120	17120	60010	4190	20.5	18.5
06	06	06	09	18	24	5210	5210	5210	7890	15630	20840	59990	3840	18.8	17.0
06	06	06	12	12	12	6670	6670	6670	13330	13330	13330	60000	4850	23.7	21.4
06	06	06	12	12	15	6320	6320	6320	12630	12630	15790	60010	4610	22.5	20.4
06	06	06	12	12	18	6000	6000	6000	12000	12000	18000	60000	4390	21.4	19.4
06	06	06	12	12	24	5450	5450	5450	10910	10910	21820	59990	4010	19.6	17.7
06	06	06	12	15	15	6000	6000	6000	12000	15000	15000	60000	4390	21.4	19.4
06	06	06	12	15	18	5710	5710	5710	11430	14290	17140	59990	4190	20.5	18.5
06	06	06	12	15	24	5220	5220	5220	10430	13040	20870	60000	3840	18.8	17.0
06	06	06	12	18	18	5450	5450	5450	10910	16360	16360	59980	4010	19.6	17.7
06	06	06	15	15	15	5710	5710	5710	14290	14290	14290	60000	4190	20.5	18.5
06	06	06	15	15	18	5450	5450	5450	13640	13640	16360	59990	4010	19.6	17.7
06	06	06	15	18	18	5220	5220	5220	13040	15650	15650	60000	3840	18.8	17.0
06	06	09	09	09	09	7200	7200	10900	10900	10900	10900	58000	5240	25.6	23.2
06	06	09	09	09	12	7020	7020	10630	10630	10630	14050	59980	5120	25.0	22.6
06	06	09	09	09	15	6640	6640	10050	10050	10050	16590	60020	4850	23.7	21.4
06	06	09	09	09	18	6290	6290	9520	9520	9520	18860	60000	4610	22.5	20.4
06	06	09	09	09	24	5690	5690	8620	8620	8620	22770	60010	4190	20.5	18.5
06	06	09	09	12	12	6650	6650	10060	10060	13290	13290	60000	4850	23.7	21.4
06	06	09	09	12	15	6300	6300	9530	9530	12590	15740	59990	4610	22.5	20.4
06	06	09	09	12	18	5980	5980	9060	9060	11970	17950	60000	4390	21.4	19.4
06	06	09	09	12	24	5440	5440	8240	8240	10880	21760	60000	4010	19.6	17.7
06	06	09	09	15	15	5980	5980	9060	9060	14960	14960	60000	4390	21.4	19.4
06	06	09	09	15	18	5700	5700	8630	8630	14250	17100	60010	4190	20.5	18.5
06	06	09	09	15	24	5200	5200	7880	7880	13010	20820	59990	3840	18.8	17.0
06	06	09	09	18	18	5440	5440	8240	8240	16320	16320	60000	4010	19.6	17.7
06	06	09	12	12	12	6310	6310	9550	12610	12610	12610	60000	4610	22.5	20.4
06	06	09	12	12	15	5990	5990	9070	11980	11980	14980	59990	4390	21.4	19.4
06	06	09	12	12	18	5710	5710	8640	11410	11410	17120	60000	4190	20.5	18.5
06	06	09	12	12	24	5210	5210	7890	10420	10420	20840	59990	3840	18.8	17.0
06	06	09	12	15	15	5710	5710	8640	11410	14270	14270	60010	4190	20.5	18.5
06	06	09	12	15	18	5450	5450	8250	10900	13620	16340	60010	4010	19.6	17.7
06	06	09	12	18	18	5210	5210	7890	10420	15630	15630	59990	3840	18.8	17.0
06	06	09	15	15	15	5450	5450	8250	13620	13620	13620	60010	4010	19.6	17.7
06	06	09	15	15	18	5210	5210	7890	13030	13030	15630	60000	3840	18.8	17.0

<Heating>

Indoor unit combinations							Capacity of each unit (BTU/h)							Total rated capacity (BTU/h)	Outdoor unit input (W)	Outdoor unit current (A)	
Unit							Unit A	Unit B	Unit C	Unit D	Unit E	Unit F	Unit G			208V	230V
A	B	C	D	E	F	G											
06	06	12	12	12	12	-	6000	6000	12000	12000	12000	12000	-	60000	4390	21.4	19.4
06	06	12	12	12	15	-	5710	5710	11430	11430	11430	14290	-	60000	4190	20.5	18.5
06	06	12	12	12	18	-	5450	5450	10910	10910	10910	16360	-	59990	4010	19.6	17.7
06	06	12	12	15	15	-	5450	5450	10910	10910	13640	13640	-	60000	4010	19.6	17.7
06	06	12	12	15	18	-	5220	5220	10430	10430	13040	15650	-	59990	3840	18.8	17.0
06	06	12	15	15	15	-	5220	5220	10430	13040	13040	13040	-	59990	3840	18.8	17.0
06	09	09	09	09	09	-	7000	10600	10600	10600	10600	10600	-	60000	5120	25.0	22.6
06	09	09	09	09	12	-	6630	10030	10030	10030	10030	13250	-	60000	4850	23.7	21.4
06	09	09	09	09	15	-	6280	9510	9510	9510	9510	15700	-	60020	4610	22.5	20.4
06	09	09	09	09	18	-	5970	9030	9030	9030	9030	17900	-	59990	4390	21.4	19.4
06	09	09	09	09	24	-	5430	8220	8220	8220	8220	21710	-	60020	4010	19.6	17.7
06	09	09	09	12	12	-	6290	9520	9520	9520	12580	12580	-	60010	4610	22.5	20.4
06	09	09	09	12	15	-	5980	9050	9050	9050	11950	14940	-	60020	4390	21.4	19.4
06	09	09	09	12	18	-	5690	8620	8620	8620	11380	17080	-	60010	4190	20.5	18.5
06	09	09	09	12	24	-	5200	7870	7870	7870	10400	20790	-	60000	3840	18.8	17.0
06	09	09	09	15	15	-	5690	8620	8620	8620	14230	14230	-	60010	4190	20.5	18.5
06	09	09	09	15	18	-	5430	8230	8230	8230	13580	16300	-	60000	4010	19.6	17.7
06	09	09	09	18	18	-	5200	7870	7870	7870	15600	15600	-	60010	3840	18.8	17.0
06	09	09	12	12	12	-	5980	9060	9060	11970	11970	11970	-	60010	4390	21.4	19.4
06	09	09	12	12	15	-	5700	8630	8630	11400	11400	14250	-	60010	4190	20.5	18.5
06	09	09	12	12	18	-	5440	8240	8240	10880	10880	16320	-	60000	4010	19.6	17.7
06	09	09	12	15	15	-	5440	8240	8240	10880	13600	13600	-	60000	4010	19.6	17.7
06	09	09	12	15	18	-	5200	7880	7880	10410	13010	15610	-	59990	3840	18.8	17.0
06	09	09	15	15	15	-	5200	7880	7880	13010	13010	13010	-	59990	3840	18.8	17.0
06	09	12	12	12	12	-	5710	8640	11410	11410	11410	11410	-	59990	4190	20.5	18.5
06	09	12	12	12	15	-	5450	8250	10900	10900	10900	13620	-	60020	4010	19.6	17.7
06	09	12	12	12	18	-	5210	7890	10420	10420	10420	15630	-	59990	3840	18.8	17.0
06	09	12	12	15	15	-	5210	7890	10420	10420	13030	13030	-	60000	3840	18.8	17.0
06	12	12	12	12	12	-	5450	10910	10910	10910	10910	10910	-	60000	4010	19.6	17.7
06	12	12	12	12	15	-	5220	10430	10430	10430	10430	13040	-	59980	3840	18.8	17.0
09	09	09	09	09	09	-	10000	10000	10000	10000	10000	10000	-	60000	4850	23.7	21.4
09	09	09	09	09	12	-	9490	9490	9490	9490	9490	12540	-	59990	4610	22.5	20.4
09	09	09	09	09	15	-	9020	9020	9020	9020	9020	14900	-	60000	4390	21.4	19.4
09	09	09	09	09	18	-	8590	8590	8590	8590	8590	17030	-	59980	4190	20.5	18.5
09	09	09	09	09	24	-	7850	7850	7850	7850	7850	20740	-	59990	3840	18.8	17.0
09	09	09	09	12	12	-	9030	9030	9030	9030	11930	11930	-	59980	4390	21.4	19.4
09	09	09	09	12	15	-	8610	8610	8610	8610	11370	14210	-	60020	4190	20.5	18.5
09	09	09	09	12	18	-	8220	8220	8220	8220	10850	16280	-	60010	4010	19.6	17.7
09	09	09	09	15	15	-	8220	8220	8220	8220	13570	13570	-	60020	4010	19.6	17.7
09	09	09	09	15	18	-	7860	7860	7860	7860	12980	15580	-	60000	3840	18.8	17.0
09	09	09	12	12	12	-	8620	8620	8620	11380	11380	11380	-	60000	4190	20.5	18.5
09	09	09	12	12	15	-	8230	8230	8230	10870	10870	13580	-	60010	4010	19.6	17.7
09	09	09	12	12	18	-	7870	7870	7870	10400	10400	15600	-	60010	3840	18.8	17.0
09	09	09	12	15	15	-	7870	7870	7870	10400	13000	13000	-	60010	3840	18.8	17.0
09	09	12	12	12	12	-	8240	8240	10880	10880	10880	10880	-	60000	4010	19.6	17.7
09	09	12	12	12	15	-	7880	7880	10410	10410	10410	13010	-	60000	3840	18.8	17.0
09	12	12	12	12	12	-	7890	10420	10420	10420	10420	10420	-	59990	3840	18.8	17.0
06	06	06	06	06	06	06	7200	7200	7200	7200	7200	7200	7200	50400	4870	23.8	21.5
06	06	06	06	06	06	09	7200	7200	7200	7200	7200	7200	10900	54100	5060	24.7	22.4
06	06	06	06	06	06	12	7200	7200	7200	7200	7200	7200	14400	57600	5210	25.5	23.0
06	06	06	06	06	06	15	7060	7060	7060	7060	7060	7060	17650	60010	5120	25.0	22.6
06	06	06	06	06	06	18	6670	6670	6670	6670	6670	6670	20000	60020	4850	23.7	21.4
06	06	06	06	06	06	24	6000	6000	6000	6000	6000	6000	24000	60000	4390	21.4	19.4
06	06	06	06	06	09	09	7200	7200	7200	7200	7200	10900	10900	57800	5230	25.6	23.1
06	06	06	06	06	09	12	7050	7050	7050	7050	7050	10670	14090	60010	5120	25.0	22.6
06	06	06	06	06	09	15	6660	6660	6660	6660	6660	10080	16640	60020	4850	23.7	21.4
06	06	06	06	06	09	18	6310	6310	6310	6310	6310	9550	18920	60020	4610	22.5	20.4

<Heating>

Indoor unit combinations							Capacity of each unit (BTU/h)							Total rated capacity (BTU/h)	Outdoor unit input (W)	Outdoor unit current (A)	
Unit							Unit A	Unit B	Unit C	Unit D	Unit E	Unit F	Unit G			208V	230V
06	06	06	06	06	09	24	5710	5710	5710	5710	5710	8640	22830	60020	4190	20.5	18.5
06	06	06	06	06	12	12	6670	6670	6670	6670	6670	13330	13330	60010	4850	23.7	21.4
06	06	06	06	06	12	15	6320	6320	6320	6320	6320	12630	15790	60020	4610	22.5	20.4
06	06	06	06	06	12	18	6000	6000	6000	6000	6000	12000	18000	60000	4390	21.4	19.4
06	06	06	06	06	12	24	5450	5450	5450	5450	5450	10910	21820	59980	4010	19.6	17.7
06	06	06	06	06	15	15	6000	6000	6000	6000	6000	15000	15000	60000	4390	21.4	19.4
06	06	06	06	06	15	18	5710	5710	5710	5710	5710	14290	17140	59980	4190	20.5	18.5
06	06	06	06	06	15	24	5220	5220	5220	5220	5220	13040	20870	60010	3840	18.8	17.0
06	06	06	06	06	18	18	5450	5450	5450	5450	5450	16360	16360	59970	4010	19.6	17.7
06	06	06	06	09	09	09	7020	7020	7020	7020	10630	10630	10630	59970	5120	25.0	22.6
06	06	06	06	09	09	12	6650	6650	6650	6650	10060	10060	13290	60010	4850	23.7	21.4
06	06	06	06	09	09	15	6300	6300	6300	6300	9530	9530	15740	60000	4610	22.5	20.4
06	06	06	06	09	09	18	5980	5980	5980	5980	9060	9060	17950	59990	4390	21.4	19.4
06	06	06	06	09	09	24	5440	5440	5440	5440	8240	8240	21760	60000	4010	19.6	17.7
06	06	06	06	09	12	12	6310	6310	6310	6310	9550	12610	12610	60010	4610	22.5	20.4
06	06	06	06	09	12	15	5990	5990	5990	5990	9070	11980	14980	59990	4390	21.4	19.4
06	06	06	06	09	12	18	5710	5710	5710	5710	8640	11410	17120	60010	4190	20.5	18.5
06	06	06	06	09	12	24	5210	5210	5210	5210	7890	10420	20840	59990	3840	18.8	17.0
06	06	06	06	09	15	15	5710	5710	5710	5710	8640	14270	14270	60020	4190	20.5	18.5
06	06	06	06	09	15	18	5450	5450	5450	5450	8250	13620	16340	60010	4010	19.6	17.7
06	06	06	06	09	18	18	5210	5210	5210	5210	7890	15630	15630	59990	3840	18.8	17.0
06	06	06	06	12	12	12	6000	6000	6000	6000	12000	12000	12000	60000	4390	21.4	19.4
06	06	06	06	12	12	15	5710	5710	5710	5710	11430	11430	14290	59990	4190	20.5	18.5
06	06	06	06	12	12	18	5450	5450	5450	5450	10910	10910	16360	59980	4010	19.6	17.7
06	06	06	06	12	15	15	5450	5450	5450	5450	10910	13640	13640	59990	4010	19.6	17.7
06	06	06	06	12	15	18	5220	5220	5220	5220	10430	13040	15650	60000	3840	18.8	17.0
06	06	06	06	15	15	15	5220	5220	5220	5220	13040	13040	13040	60000	3840	18.8	17.0
06	06	06	09	09	09	09	6630	6630	6630	10030	10030	10030	10030	60010	4850	23.7	21.4
06	06	06	09	09	09	12	6290	6290	6290	9520	9520	9520	12580	60010	4610	22.5	20.4
06	06	06	09	09	09	15	5980	5980	5980	9050	9050	9050	14940	60030	4390	21.4	19.4
06	06	06	09	09	09	18	5690	5690	5690	8620	8620	8620	17080	60010	4190	20.5	18.5
06	06	06	09	09	09	24	5200	5200	5200	7870	7870	7870	20790	60000	3840	18.8	17.0
06	06	06	09	09	12	12	5980	5980	5980	9060	9060	11970	11970	60000	4390	21.4	19.4
06	06	06	09	09	12	15	5700	5700	5700	8630	8630	11400	14250	60010	4190	20.5	18.5
06	06	06	09	09	12	18	5440	5440	5440	8240	8240	10880	16320	60000	4010	19.6	17.7
06	06	06	09	09	15	15	5440	5440	5440	8240	8240	13600	13600	60000	4010	19.6	17.7
06	06	06	09	09	15	18	5200	5200	5200	7880	7880	13010	15610	59980	3840	18.8	17.0
06	06	06	09	12	12	12	5710	5710	5710	8640	11410	11410	11410	60000	4190	20.5	18.5
06	06	06	09	12	12	15	5450	5450	5450	8250	10900	10900	13620	60020	4010	19.6	17.7
06	06	06	09	12	12	18	5210	5210	5210	7890	10420	10420	15630	59990	3840	18.8	17.0
06	06	06	09	12	15	15	5210	5210	5210	7890	10420	13030	13030	60000	3840	18.8	17.0
06	06	06	12	12	12	12	5450	5450	5450	10910	10910	10910	10910	59990	4010	19.6	17.7
06	06	06	12	12	12	15	5220	5220	5220	10430	10430	10430	13040	59990	3840	18.8	17.0
06	06	09	09	09	09	09	6270	6270	9490	9490	9490	9490	9490	59990	4610	22.5	20.4
06	06	09	09	09	09	12	5970	5970	9030	9030	9030	9030	9030	59990	4390	21.4	19.4
06	06	09	09	09	09	15	5680	5680	8610	8610	8610	8610	14210	60010	4190	20.5	18.5
06	06	09	09	09	09	18	5430	5430	8220	8220	8220	8220	16280	60020	4010	19.6	17.7
06	06	09	09	09	12	12	5690	5690	8620	8620	8620	11380	11380	60000	4190	20.5	18.5
06	06	09	09	09	12	15	5430	5430	8230	8230	8230	10870	13580	60000	4010	19.6	17.7
06	06	09	09	09	12	18	5200	5200	7870	7870	7870	10400	15600	60010	3840	18.8	17.0
06	06	09	09	09	15	15	5200	5200	7870	7870	7870	13000	13000	60010	3840	18.8	17.0
06	06	09	09	12	12	12	5440	5440	8240	8240	10880	10880	10880	60000	4010	19.6	17.7
06	06	09	09	12	12	15	5200	5200	7880	7880	10410	10410	13010	59990	3840	18.8	17.0
06	06	09	12	12	12	12	5210	5210	7890	10420	10420	10420	10420	59990	3840	18.8	17.0
06	09	09	09	09	09	09	5950	9010	9010	9010	9010	9010	9010	60010	4390	21.4	19.4
06	09	09	09	09	09	12	5680	8590	8590	8590	8590	8590	11350	59980	4190	20.5	18.5
06	09	09	09	09	09	15	5420	8210	8210	8210	8210	8210	13550	60020	4010	19.6	17.7

<Heating>

Indoor unit combinations								Capacity of each unit (BTU/h)								Total rated capacity (BTU/h)	Outdoor unit Input (W)	Outdoor unit current (A)	
Unit								Unit A	Unit B	Unit C	Unit D	Unit E	Unit F	Unit G	Unit H			208V	230V
A	B	C	D	E	F	G	H												
06	09	09	09	09	09	18	-	5190	7850	7850	7850	7850	7850	15560	-	60000	3840	18.8	17.0
06	09	09	09	09	12	12	-	5430	8220	8220	8220	8220	10850	10850	-	60010	4010	19.6	17.7
06	09	09	09	09	12	15	-	5190	7860	7860	7860	7860	10380	12980	-	59990	3840	18.8	17.0
06	09	09	09	12	12	12	-	5200	7870	7870	7870	10400	10400	10400	-	60010	3840	18.8	17.0
09	09	09	09	09	09	09	-	8570	8570	8570	8570	8570	8570	8570	-	59990	4190	20.5	18.5
09	09	09	09	09	09	12	-	8200	8200	8200	8200	8200	8200	10830	-	60030	4010	19.6	17.7
09	09	09	09	09	09	15	-	7840	7840	7840	7840	7840	7840	12950	-	59990	3840	18.8	17.0
09	09	09	09	09	12	12	-	7850	7850	7850	7850	7850	10370	10370	-	59990	3840	18.8	17.0
06	06	06	06	06	06	06	06	7200	7200	7200	7200	7200	7200	7200	7200	57600	5210	25.5	23.0
06	06	06	06	06	06	06	09	7050	7050	7050	7050	7050	7050	7050	10670	60020	5120	25.0	22.6
06	06	06	06	06	06	06	12	6670	6670	6670	6670	6670	6670	6670	13330	60020	4850	23.7	21.4
06	06	06	06	06	06	06	15	6320	6320	6320	6320	6320	6320	6320	15790	60030	4610	22.5	20.4
06	06	06	06	06	06	06	18	6000	6000	6000	6000	6000	6000	6000	18000	60000	4390	21.4	19.4
06	06	06	06	06	06	06	24	5450	5450	5450	5450	5450	5450	5450	21820	59970	4010	19.6	17.7
06	06	06	06	06	06	09	09	6650	6650	6650	6650	6650	6650	10060	10060	60020	4850	23.7	21.4
06	06	06	06	06	06	09	12	6310	6310	6310	6310	6310	6310	9550	12610	60020	4610	22.5	20.4
06	06	06	06	06	06	09	15	5990	5990	5990	5990	5990	5990	9070	14980	59990	4390	21.4	19.4
06	06	06	06	06	06	09	18	5710	5710	5710	5710	5710	5710	8640	17120	60020	4190	20.5	18.5
06	06	06	06	06	06	09	24	5210	5210	5210	5210	5210	5210	7890	20840	59990	3840	18.8	17.0
06	06	06	06	06	06	12	12	6000	6000	6000	6000	6000	6000	12000	12000	60000	4390	21.4	19.4
06	06	06	06	06	06	12	15	5710	5710	5710	5710	5710	5710	11430	14290	59980	4190	20.5	18.5
06	06	06	06	06	06	12	18	5450	5450	5450	5450	5450	5450	10910	16360	59970	4010	19.6	17.7
06	06	06	06	06	06	15	15	5450	5450	5450	5450	5450	5450	13640	13640	59980	4010	19.6	17.7
06	06	06	06	06	06	15	18	5220	5220	5220	5220	5220	5220	13040	15650	60010	3840	18.8	17.0
06	06	06	06	06	09	09	09	6290	6290	6290	6290	6290	9520	9520	9520	60010	4610	22.5	20.4
06	06	06	06	06	09	09	12	5980	5980	5980	5980	5980	9060	9060	11970	59990	4390	21.4	19.4
06	06	06	06	06	09	09	15	5700	5700	5700	5700	5700	8630	8630	14250	60010	4190	20.5	18.5
06	06	06	06	06	09	09	18	5440	5440	5440	5440	5440	8240	8240	16320	60000	4010	19.6	17.7
06	06	06	06	06	09	12	12	5710	5710	5710	5710	5710	8640	11410	11410	60010	4190	20.5	18.5
06	06	06	06	06	09	12	15	5450	5450	5450	5450	5450	8250	10900	13620	60020	4010	19.6	17.7
06	06	06	06	06	09	12	18	5210	5210	5210	5210	5210	7890	10420	15630	59990	3840	18.8	17.0
06	06	06	06	06	09	15	15	5210	5210	5210	5210	5210	7890	13030	13030	60000	3840	18.8	17.0
06	06	06	06	06	12	12	12	5450	5450	5450	5450	5450	10910	10910	10910	59980	4010	19.6	17.7
06	06	06	06	06	12	12	15	5220	5220	5220	5220	5220	10430	10430	13040	60000	3840	18.8	17.0
06	06	06	06	09	09	09	09	5970	5970	5970	5970	9030	9030	9030	9030	60000	4390	21.4	19.4
06	06	06	06	09	09	09	12	5690	5690	5690	5690	8620	8620	8620	11380	60000	4190	20.5	18.5
06	06	06	06	09	09	09	15	5430	5430	5430	5430	8230	8230	8230	13580	59990	4010	19.6	17.7
06	06	06	06	09	09	09	18	5200	5200	5200	5200	7870	7870	7870	15600	60010	3840	18.8	17.0
06	06	06	06	09	09	12	12	5440	5440	5440	5440	8240	8240	10880	10880	60000	4010	19.6	17.7
06	06	06	06	09	09	12	15	5200	5200	5200	5200	7880	7880	10410	13010	59980	3840	18.8	17.0
06	06	06	06	09	12	12	12	5210	5210	5210	5210	7890	10420	10420	10420	59990	3840	18.8	17.0
06	06	06	09	09	09	09	09	5680	5680	5680	8590	8590	8590	8590	8590	59990	4190	20.5	18.5
06	06	06	09	09	09	09	12	5430	5430	5430	8220	8220	8220	8220	10850	60020	4010	19.6	17.7
06	06	06	09	09	09	09	15	5190	5190	5190	7860	7860	7860	7860	12980	59990	3840	18.8	17.0
06	06	06	09	09	09	12	12	5200	5200	5200	7870	7870	7870	10400	10400	60010	3840	18.8	17.0
06	06	09	09	09	09	09	09	5410	5410	8200	8200	8200	8200	8200	8200	60020	4010	19.6	17.7
06	06	09	09	09	09	12	15	5190	5190	7850	7850	7850	7850	7850	10370	60000	3840	18.8	17.0
06	09	09	09	09	09	09	09	5170	7830	7830	7830	7830	7830	7830	7830	59980	3840	18.8	17.0

4-2. CORRECTING COOLING AND HEATING CAPACITY

4-2-1. Correcting Changes in Air Conditions

(1) The performance curve charts (Figure 1-1, 1-2, 2-1, 2-2) show the change ratio of capacity and input (power consumption) according to the indoor and outdoor temperature condition when define the rated capacity (total capacity) and rated input under the standard condition in standard piping length (5m) as "1.0".

• Standard conditions:

Rated cooling capacity	Indoor D.B. 80°F / W.B. 67°F Outdoor D.B. 95°F
Rated heating capacity	Indoor D.B. 70°F Outdoor D.B. 47°F / W.B. 43°F

- Use the rated capacity and rated power values given in the characteristics table for each indoor unit.
- The capacity is the single value on the side of the outdoor unit;
The capacity on the sides of each indoor unit must be added to obtain the total capacity.

(2) The capacity of each indoor unit may be obtained by multiplying the total capacity obtained in (1) by the ratio between the individual capacity at the rated time and the total capacity at the rated time.

$$\text{Individual capacity under stated conditions} = \text{Total capacity under the stated conditions} \times \frac{\text{Individual capacity at the rated time}}{\text{Total capacity at the rated time}}$$

(3) Capacity correction factor curve

Fig. 1-1
Cooling capacity

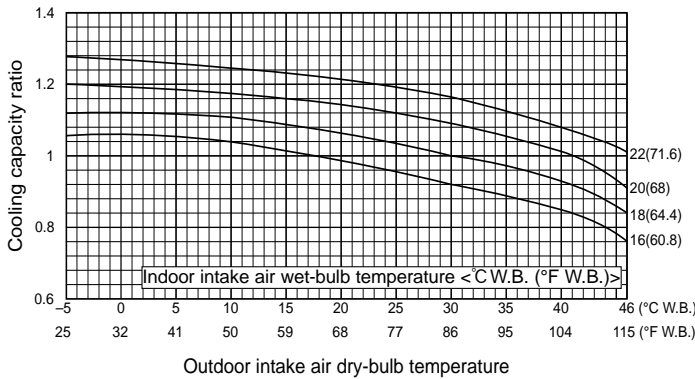

Fig. 1-2
Cooling input

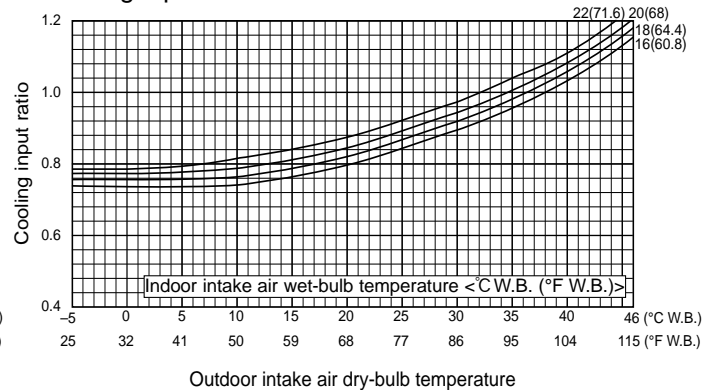

Fig. 2-1
Heating capacity

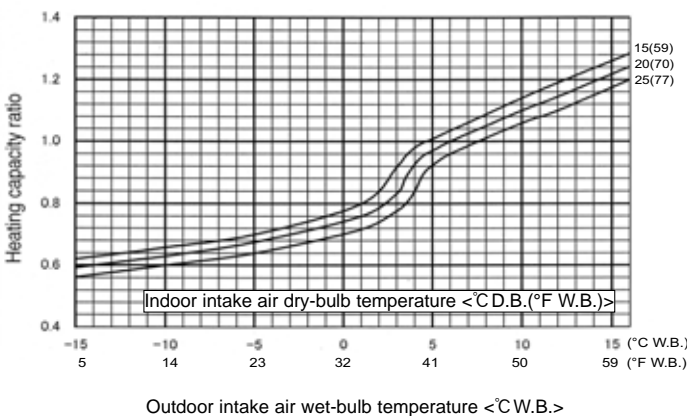
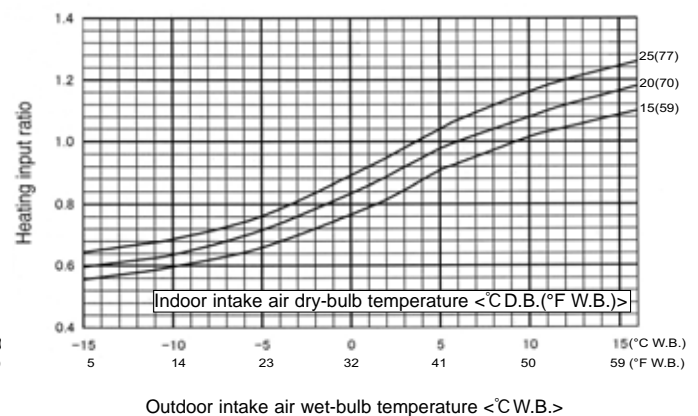

Fig. 2-2
Heating input



Note : These diagrams show the case where the operation frequency of a compressor is fixed.

4-2-2. Correcting Capacity for Changes in the Length of Refrigerant Piping

To obtain the ratio (and the corrected piping length) of the outdoor units Max. capacity and the total in-use indoor capacity, first find the capacity ratio corresponding to the standard piping length from Fig.3, Fig.4 and then multiply by the capacity from Fig. 1-1, 1-2, Fig. 2-1, 2-2 to obtain the actual capacity.

(1) Capacity correction factor

Fig. 3 Cooling capacity correction curve

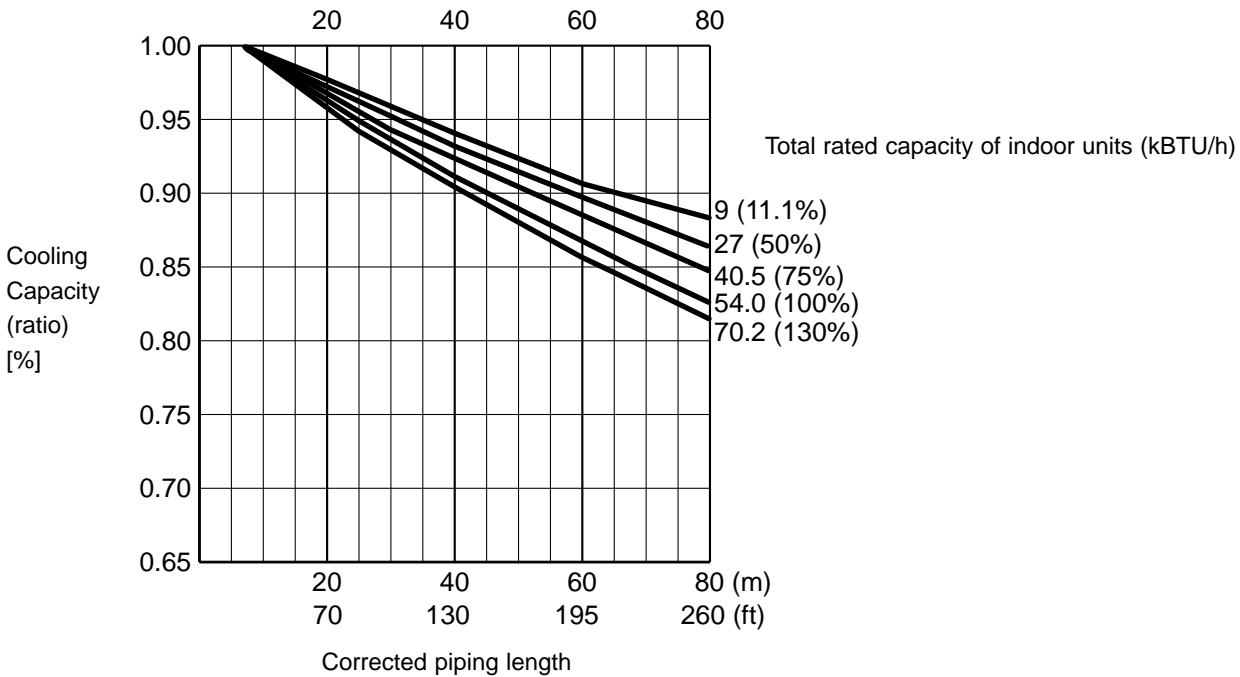
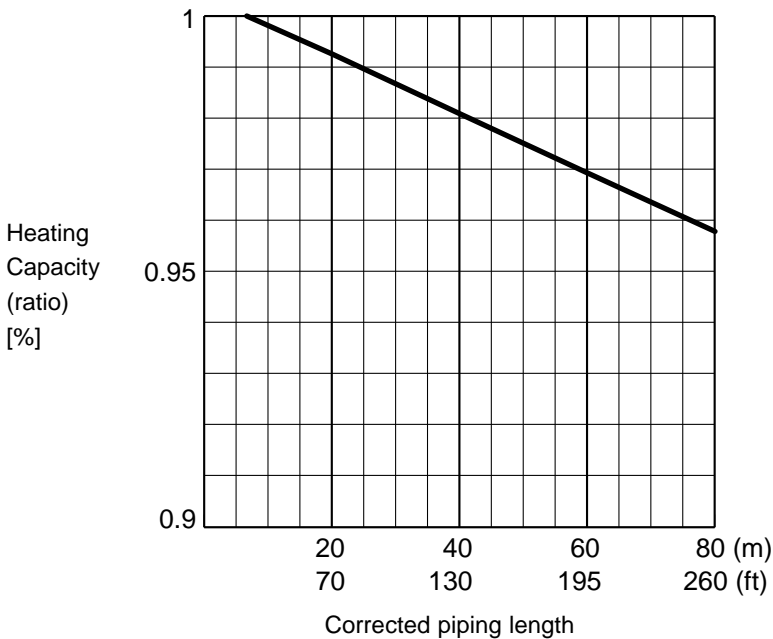

Fig. 4 Heating capacity correction curve



(2) Method for Obtaining the Corrected Piping Length

Corrected piping length = (Actual piping length between outdoor unit and the farthest indoor unit) + (0.30 × number of bends in the piping) (m), (ft)

4-3. NOISE CRITERION CURVES

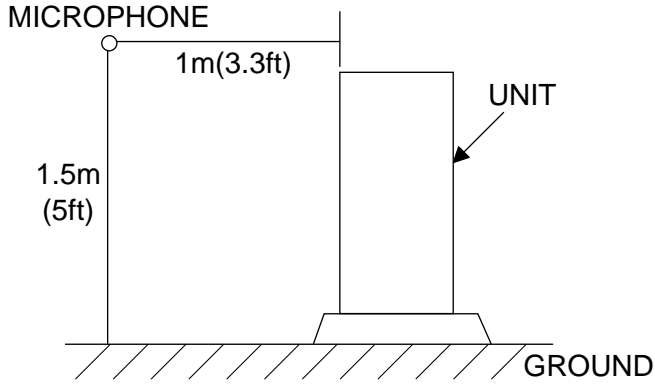

MXZ-8B48NA

MODE	SPL(dB)	LINE
COOLING	54	○—○
HEATING	55	●—●

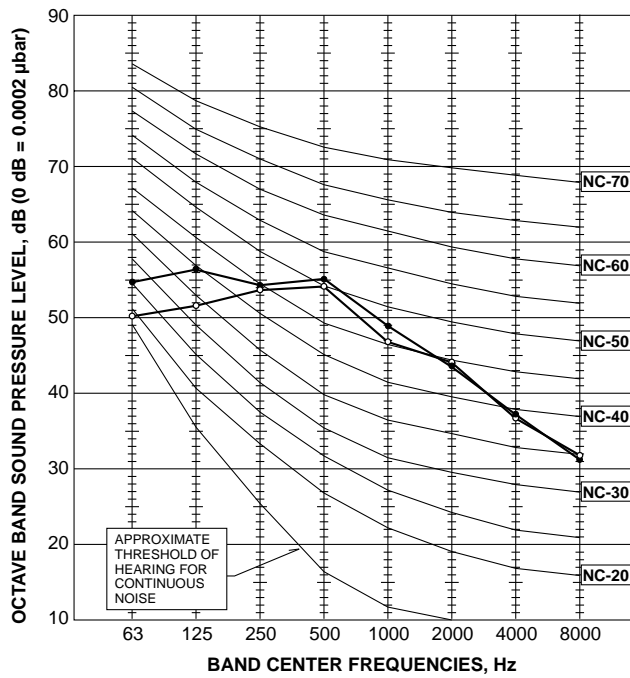

5-1. OUTDOOR UNIT
MXZ-8B48NA

unit : mm (inch)

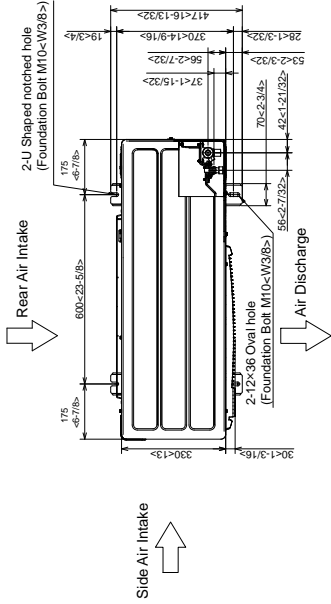

4 PIPING DIRECTIONS

Piping and wiring connections can be made from 4 directions: front, right, rear and below.

3 FOUNDATION BOLTS

Please secure the unit firmly with 4 foundation (M10×W3/8) bolts. (Bolts and washers must be purchased locally.)

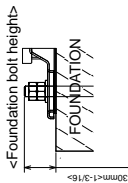

2 SERVICE SPACE

Dimensions of space needed for service access are shown in the below diagram.

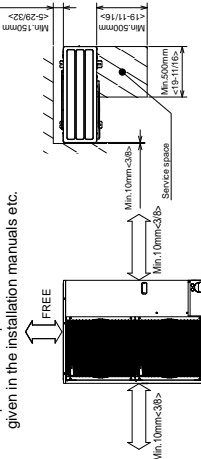

1 FREE SPACE (Around the unit)

The diagram below shows a basic example. Explanation of particular details is given in the installation manuals etc.

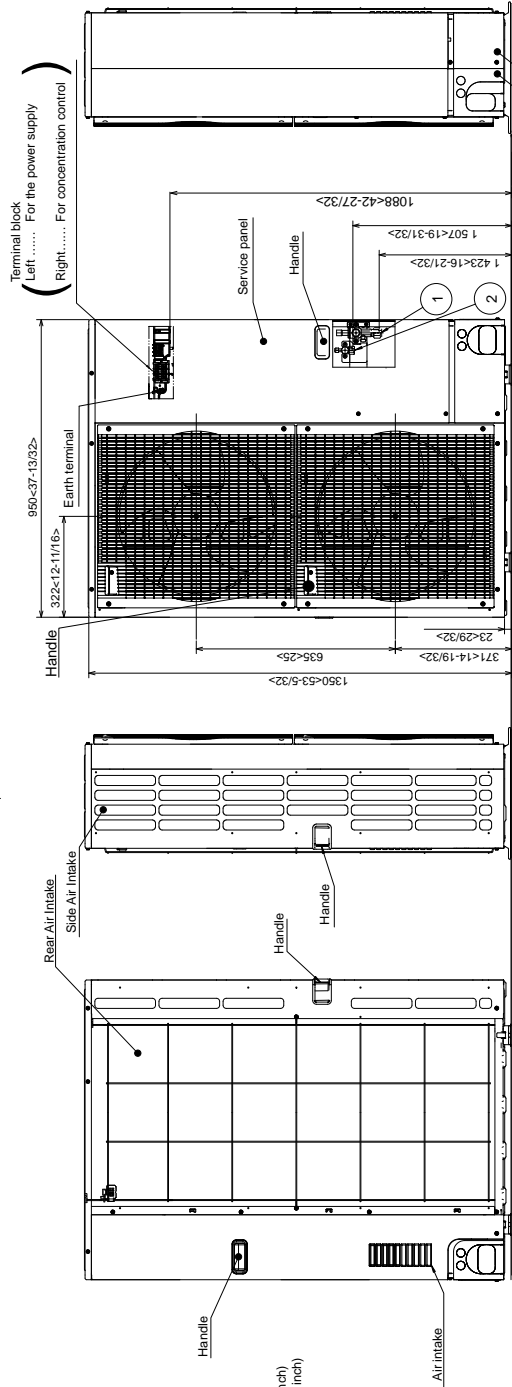

Example of Notes

- ①..... Refrigerant GAS pipe connection (FLARE)(1/4.88 / 5/8 inch)
- ②..... Refrigerant LIQUID pipe connection (FLARE)(3/8.52 / 3/8 inch)
- *1..... Indication of STOP VALVE connection location.

Piping Knockout Hole Details

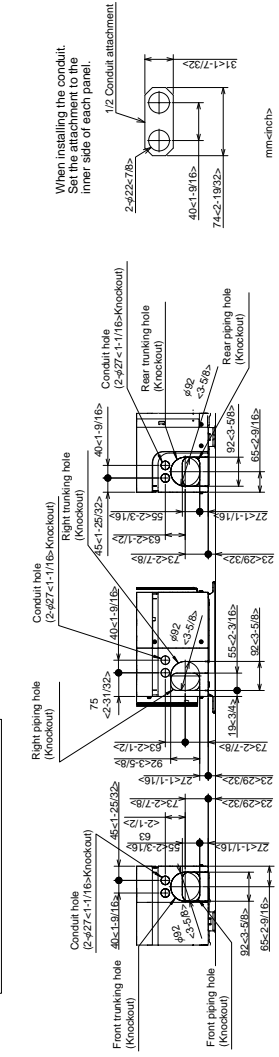

5-2. BRANCH BOX UNIT PAC-AKA51BC

unit : mm (inch)

SUSPENSION BOLT : W3/8(M10)

REFRIGERANT PIPE FLARED CONNECTION

	A	B	C	D	E	TO OUT DOOR UNIT
LIQUID PIPE	1/4F	1/4F	1/4F	1/4F	1/4F	3/8F
GAS PIPE	3/8F	3/8F	3/8F	3/8F	1/2F	5/8F

DRAIN HOSE SIZE : O.D 20<3/4> (VP-16<5/8>)

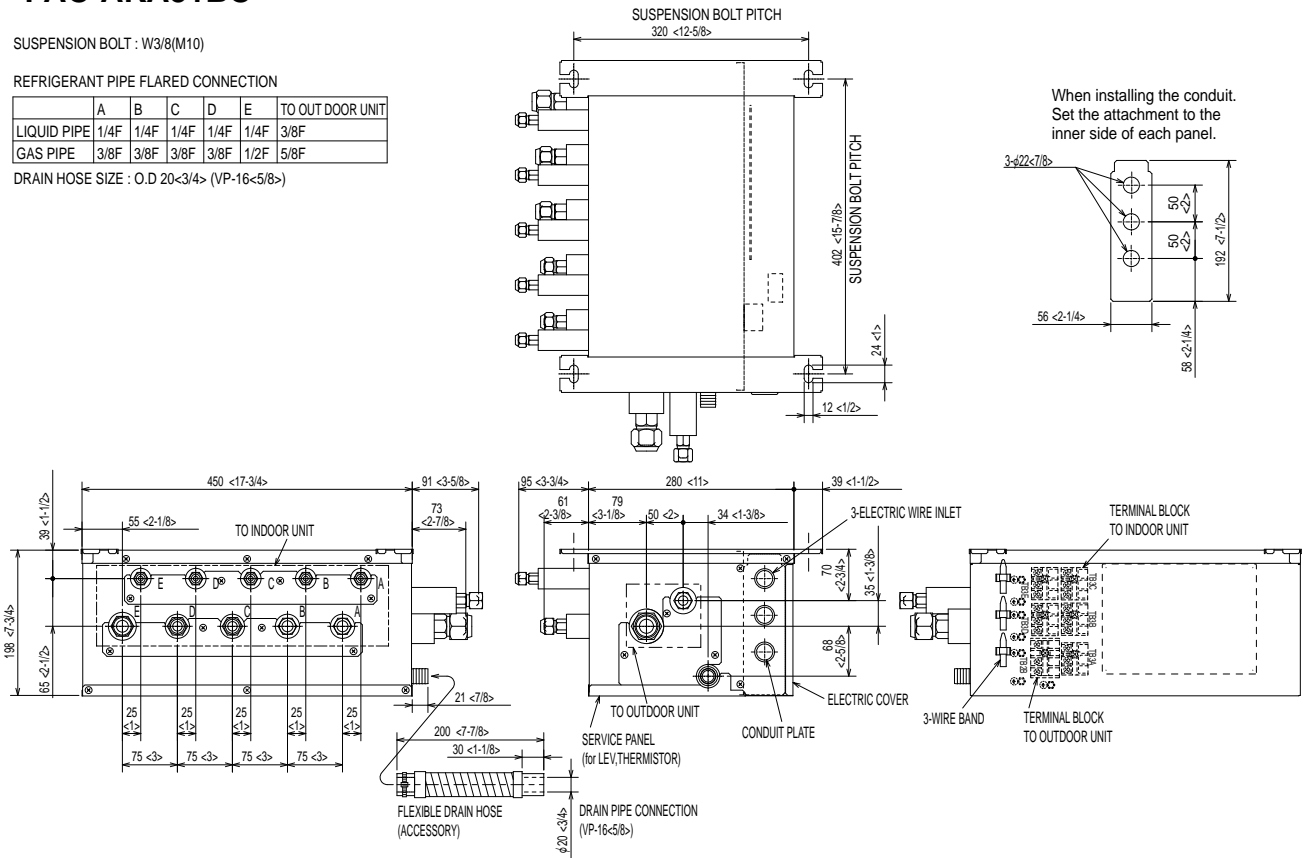

PAC-AKA31BC

SUSPENSION BOLT : W3/8(M10)

REFRIGERANT PIPE FLARED CONNECTION

	A	B	C	TO OUT DOOR UNIT
LIQUID PIPE	1/4F	1/4F	1/4F	3/8F
GAS PIPE	3/8F	3/8F	3/8F	5/8F

DRAIN HOSE SIZE : O.D 20<3/4> (VP-16<5/8>)

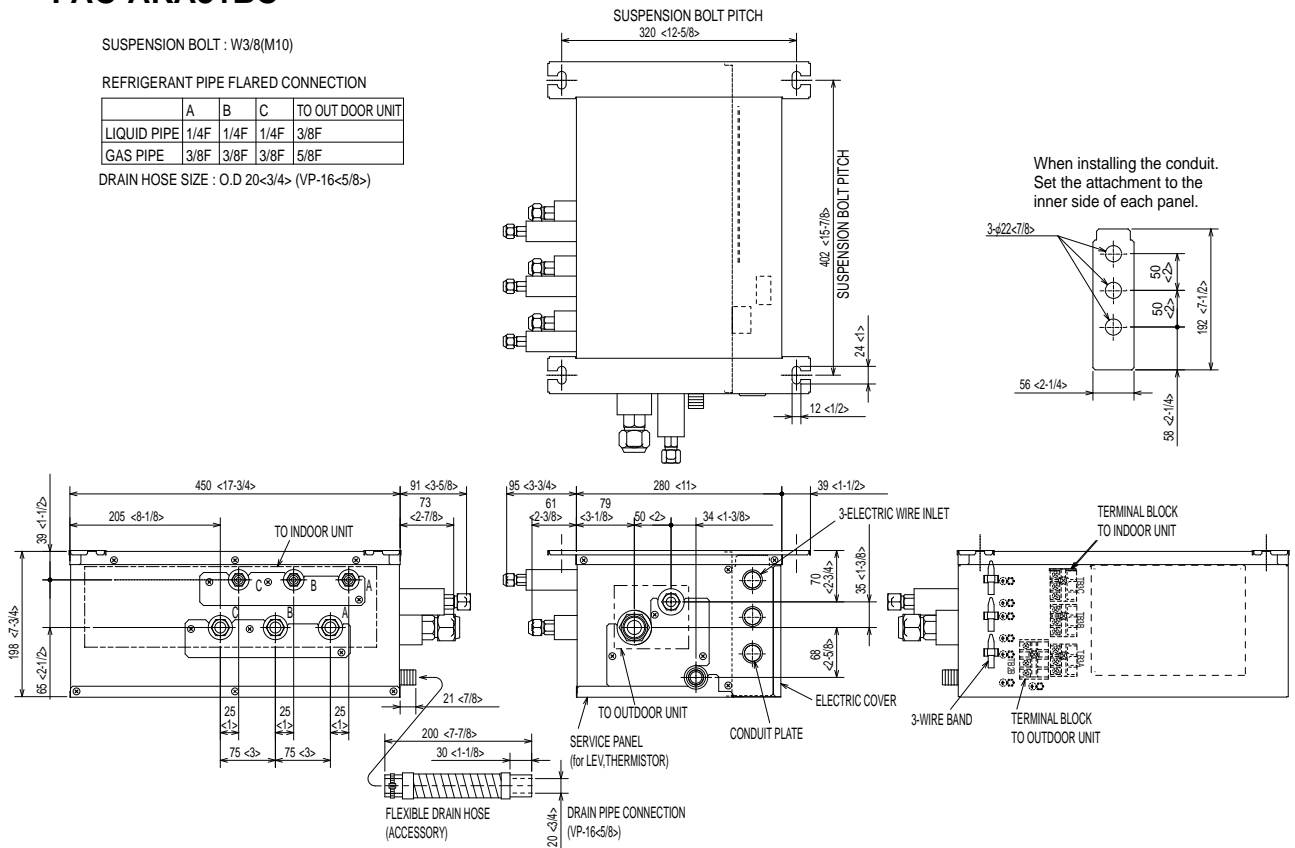

6-1. OUTDOOR UNIT
MXZ-8B48NA

SYMBOL	NAME	SYMBOL	NAME	SYMBOL	NAME
TB1	Terminal Block (Power Supply)	P.B.	Power Circuit Board	SW7	Switch (Function Setup)
TB2	Terminal Block (Branch Box)	UVW	Connection Terminal (UVW/Phase)	SW8	Switch (Function Setup)
MC	Motor for Compressor	U	Connection Terminal (U/Phase)	SW9	Switch (Function Setup)
MF1, MF2	Fan Motors	N1	Connection Terminal (L2/Phase)	CN31	Connector
21S4	Solenoid Valve (Four-Way Valve)	N2	Connection Terminal	CN51	Connector (Connection for Option)
63H	High Pressure Switch	DCL1, DCL2	Connection Terminal (Reactor)	CN52	Connector (Connection for Option)
63L	Low Pressure Switch	IGBT	Power Module	CN1T	Connector (Connection for Option)
63HS	High Pressure Sensor	E1, E2, E3, E4	Connection Terminal (Ground)	CN1M	Connector <Connected for Option (Contact Input)>
SV1, SV2	Solenoid Valve (Bypass Valve)	C.B.	Controller Circuit Board	LED1, 2	Light Emitting Diode
TH3	Thermistor (Outdoor Pipe)	SW1	Switch (Self Diagnosis Switch)	LED3	Light Emitting Diode
TH4	Thermistor (Discharge)	SW2	Switch (Self Diagnosis Switch)	LED4	Light Emitting Diode
TH6	Thermistor (Outdoor 2 - Phase Pipe)	SW4	Switch (Test Operation)	F1 ~ F4	Fuse (T16-3AL250V)
TH7	Thermistor (Outdoor)	SW5	Switch (Function Switch)	X51 ~ X55	Relay
DCL	Reactor	SW6	Switch (Metal Select)		
CB	Main Smoothing Capacitor				

Operation / Inspection Display

LED3 on the controller board displays the operation and inspection status as follows.
If LED3 does not light, it indicates that no power is supplied to the board.

Code	Details
Power turned on	
Normal status	
Faulty status (blinking)	
F3	63L connector (red) is open.
F5	63H connector (yellow) is open.
F9	2 connectors (63H/63L) are open.
E8	Branch box/outdoor communication error (Signal receiving error)(Outdoor unit)
E9	Indoor/branch box communication error (Signal receiving error)(Branch box)
E8	Indoor/branch box communication error (Transmitting error)(Outdoor unit)
E9	Indoor/branch box communication error (Transmitting error)(Branch box)
EA	Mis-Wiring of indoor-branch box / branch box-outdoor unit connecting wire. · Too many indoor units / branch box are in the system.
Ea	Mis-wiring of indoor-branch box/branch box-outdoor unit connecting wire (converse wiring or disconnection)
Ec	Startup time over
Eb	Communication error except for outdoor unit
E0 - E7	Combination error, undefined error
EE, EF	Serial communication error
Eg	Discharge temperature fault
U2	Low-discharge superheating fault, Erroneous connection of refrigerant pipes or the connecting wires
U7	High pressure fault (63H operates)
U1	Low pressure fault (63L operates)
U6	Abnormality of power moduls
Uf	Compressor over current shutdown (Start up locked)
Ug	Current sensor fault (P. B.)
Uh	Compressor overcurrent shutdown fault
Up	Discharge pipe/compressor thermistor (TH4) open or short-circuit
U3	Outdoor unit thermistors (TH3, TH6, and TH7), 63HS, and branch box thermistors open or short-circuit
U4	Radiator panel temperature fault
U5	Abnormality in outdoor fan motor
U8	Voltage fault, current sensor fault (P. B.)
U9	Forced compressor stop
PA	(Overlap malfunction of drain pump in indoor unit and linear expansion valve in branch box)

Caution for electrical work

- Use copper supply wires.

Cautions when Servicing

- **WARNING:** When the main supply is turned off, the voltage [325 V] in the main capacitor will drop to 20 V in approx. 2 minutes (input voltage : 230 V), when servicing, make sure that LEDs on the outdoor circuit board go out, and then wait for at least 1 minute.
- Components other than the outdoor board may be faulty : Check and take corrective action, referring to the service manual. Do not replace the outdoor board without checking.

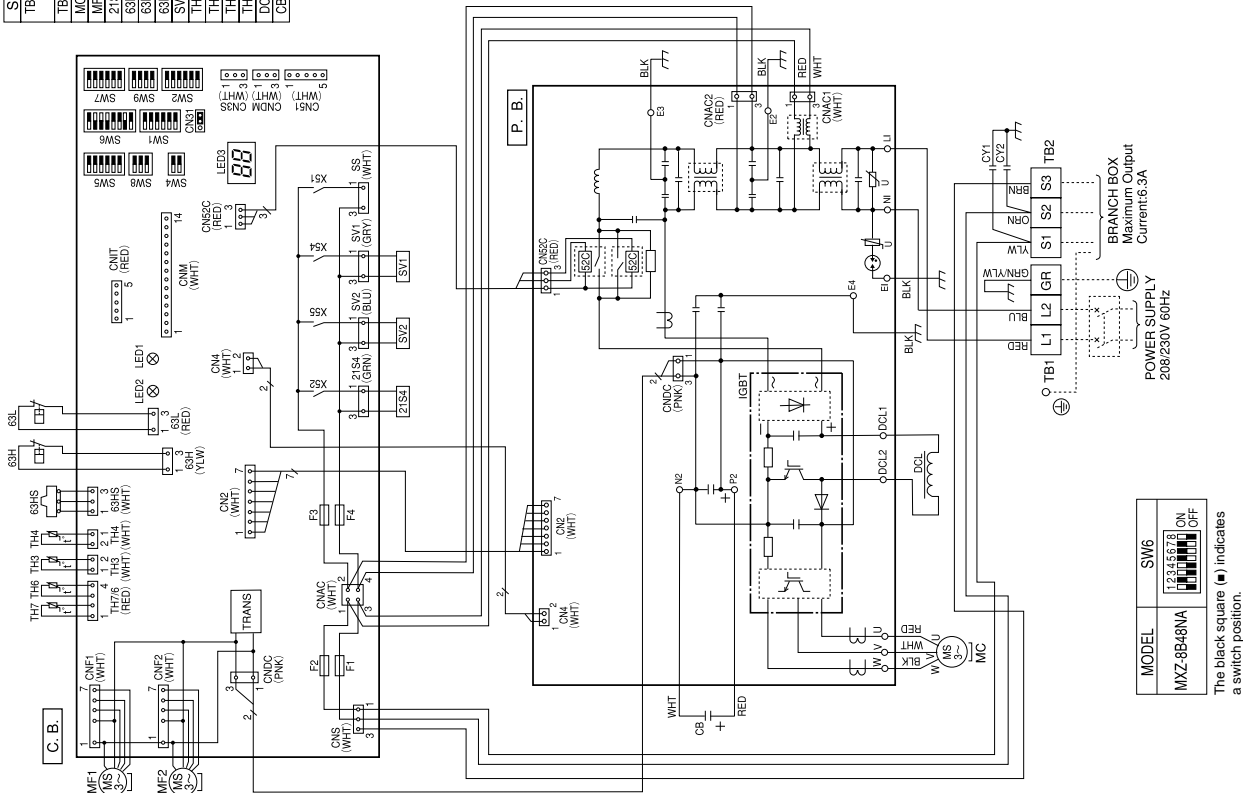

MODEL	SW6
MXZ-8B48NA	12345678 ON OFF

The black square (■) indicates a switch position.

6-2. BRANCH BOX : PAC-AKA51BC PAC-AKA31BC

Note : " PAC - AKA31 · 51BC " is only for R410A.

SYMBOL	NAME
B.C	Branch box controller board
F1 <B.C>	Fuse 250V 6.3A
SW1 <B.C>	Switch for service
CNM <B.C>	Connector
LED1~5 <B.C>	Light emitting diode
LEV-A~E	Linear expansion valve
TH-A~E	Thermistor Pipe temp.detection / Gas (32°F / 15k Ω, 77°F / 5.4k Ω)
TB2B	Terminal block / To outdoor unit
TB3A	Terminal block / To indoor unit - A
TB3B	Terminal block / To indoor unit - B
TB3C	Terminal block / To indoor unit - C
TB3D	Terminal block / To indoor unit - D
TB3E	Terminal block / To indoor unit - E

Note

- At servicing for outdoor unit, always follow the wiring diagram of Outdoor unit.
- Symbols used in wiring diagram above are,
 ◎ : terminal block, □ □ □ : connector.
- Caution for electrical work.
 · Use copper supply wires.

<Combination of indoor units>

Enter the location of combined indoor units with model name in each blank below because it is necessary for service and maintenance.

Indoor unit - A	Indoor unit - B	Indoor unit - C	Indoor unit - D	Indoor unit - E

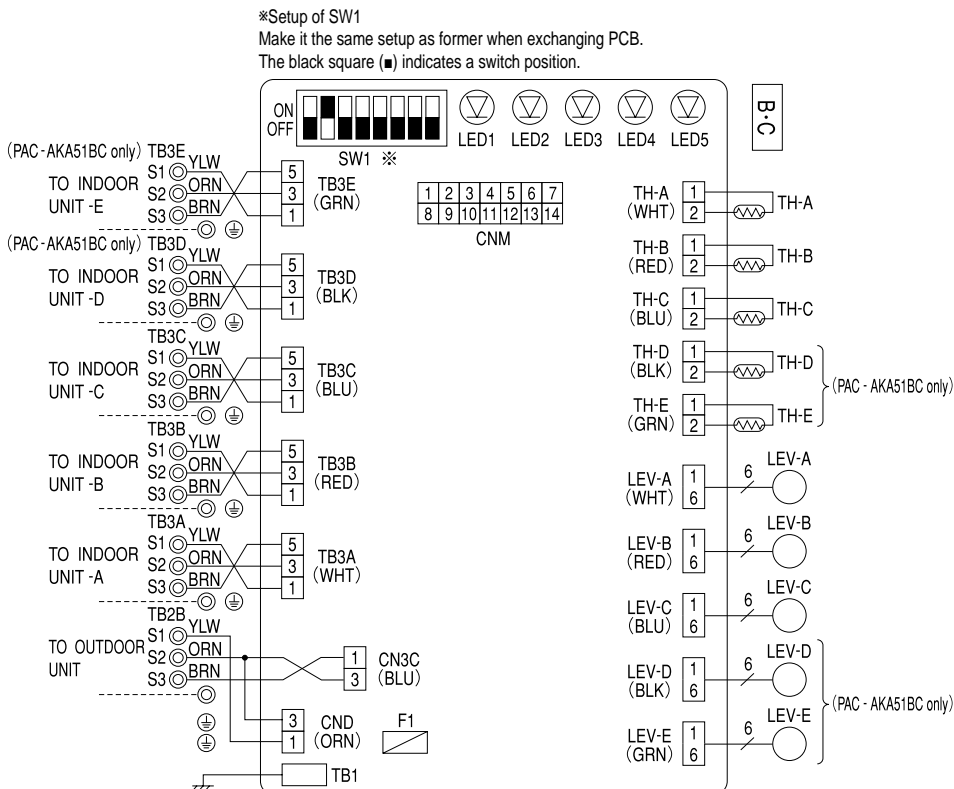

7 NECESSARY CONDITIONS FOR SYSTEM CONSTRUCTION

REFRIGERANT SYSTEM DIAGRAM MXZ-8B48NA

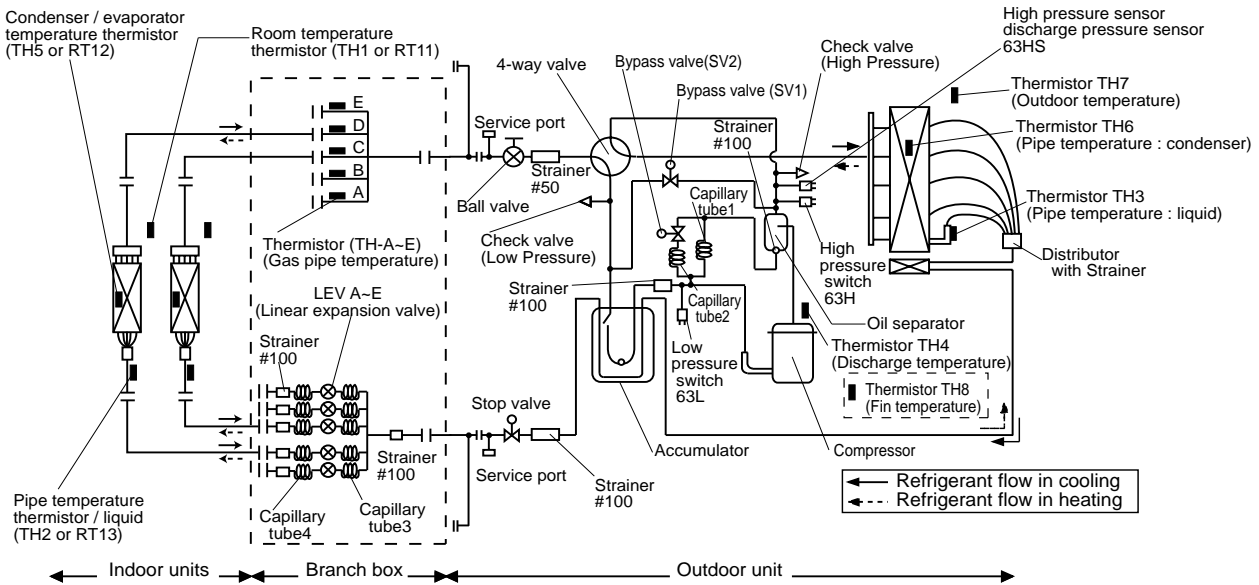

unit : mm (inch)

		Capillary tube 1 (For return of oil from oil separator)	Capillary tube 2 (For SV2)	Capillary tube 3 ahead of LEV (in cooling mode)	Capillary tube 4 behind LEV (in cooling mode)
Outdoor unit	MXZ-8B48NA	$\phi 2.5 \times \phi 0.8 \times L1000$ ($\phi 0.098 \times \phi 0.031 \times L(39-1/2)$)	$\phi 4 \times \phi 2.4 \times L250$ ($\phi 0.157 \times \phi 0.094 \times L10$)	—	—
Branch box	PAC-AKA51BC	—	—	$(\phi 4 \times \phi 2.4 \times L140) \times 5$ ($\phi 0.157 \times \phi 0.094 \times L(5-1/2)$) $\times 5$	$(\phi 4 \times \phi 2.2 \times L130) \times 5$ ($\phi 0.157 \times \phi 0.087 \times L(5-1/8)$) $\times 5$
	PAC-AKA31BC	—	—	$(\phi 4 \times \phi 2.4 \times L140) \times 3$ ($\phi 0.157 \times \phi 0.094 \times L(5-1/2)$) $\times 3$	$(\phi 4 \times \phi 2.2 \times L130) \times 3$ ($\phi 0.157 \times \phi 0.087 \times L(5-1/8)$) $\times 3$

Piping connection size

	A	B
Liquid (mm)	$\phi 9.52$	The pipe connection size differs according to the type and capacity of indoor units. Match the piping connection size of branch box with indoor unit. If the piping connection size of branch box does not match the piping connection size of indoor unit, use optional different-diameter (deformed) joints to the branch box side. (Connect deformed joint directly to the branch box side.)
Gas (mm)	$\phi 15.88$	

- In case of using 1-branch box
Flare connection employed (No. brazing)

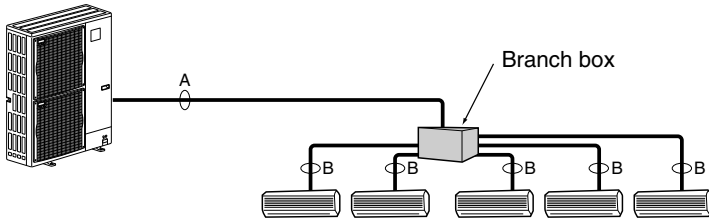

- In case of using 2-branch boxes

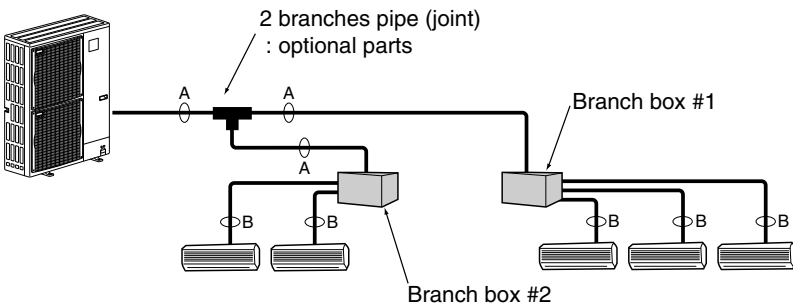

- installation procedure (2 branch pipe (joint))
Refer to the installation manuals of MSDD-50AR-E and MSDD-50BR-E.

8-1. TROUBLESHOOTING

<Error code display by self-diagnosis and actions to be taken for service (summary)>

Present and past error codes are logged and displayed on the wired remote controller and control board of outdoor unit. Actions to be taken for service, which depends on whether or not the trouble is reoccurring at service, are summarized in the table below. Check the contents below before investigating details.

Unit conditions at service	Error code	Actions to be taken for service (summary)
The trouble has reoccurred.	Displayed	Judge what is wrong and take a corrective action according to "8-3. SELF-DIAGNOSIS ACTION TABLE".
	Not displayed	Conduct trouble shooting and ascertain the cause of the trouble according to "8-4. TROUBLESHOOTING BY INFERIOR PHENOMENA".
The trouble is not reoccurring.	Logged	<ul style="list-style-type: none"> ①Consider the temporary defects such as the work of protection devices in the refrigerant circuit including compressor, poor connection of wiring, noise and etc. Re-check the symptom, and check the installation environment, refrigerant amount, weather when the trouble occurred, matters related to wiring and etc. ②Reset error code logs and restart the unit after finishing service. ③There is no abnormality concerning of parts such as electrical component, controller board, remote controller and etc.
	Not logged	<ul style="list-style-type: none"> ①Re-check the abnormal symptom. ②Conduct trouble shooting and ascertain the cause of the trouble according to "8-4. TROUBLESHOOTING BY INFERIOR PHENOMENA". ③Continue to operate unit for the time being if the cause is not ascertained. ④There is no abnormality concerning of parts such as electrical component, controller board, remote controller and etc.

8-2. CHECK POINTS FOR TEST RUN

8-2-1. Before test run

- Turn on the main power switch more than 12 hours before starting operation. Starting operation just after turning on the power switch can severely damage the internal parts. Keep the main power switch turned on during the operation season.
- After completing installation and the wiring and piping of the indoor and outdoor units, check for refrigerant leakage, looseness in the power supply or control wiring, wrong polarity, and no disconnection of one phase in the supply.
- Use a 500-volt M-ohm tester to check that the resistance between the power supply terminals and ground is at least 1 MΩ.
- Do not carry out this test on the control wiring (low voltage circuit) terminals.

⚠ Warning: Do not use the air conditioner if the insulation resistance is less than 1 MΩ.

Insulation resistance

After installation or after the power source to the unit has been cut for an extended period, the insulation resistance will drop below 1 MΩ due to refrigerant accumulating in the compressor. This is not a malfunction. Perform the following procedures.

1. Remove the wires from the compressor and measure the insulation resistance of the compressor.
2. If the insulation resistance is below 1 MΩ, the compressor is faulty or the resistance dropped due to the accumulation of refrigerant in the compressor.
3. After connecting the wires to the compressor, the compressor will start to warm up after power is supplied. After supplying power for the times indicated below, measure the insulation resistance again.
 - The insulation resistance drops due to accumulation of refrigerant in the compressor. The resistance will rise above 1MΩ after the compressor is warmed up for 4 hours. (The time necessary to warm up the compressor varies according to atmospheric conditions and refrigerant accumulation.)
 - To operate the compressor with refrigerant accumulated in the compressor, the compressor must be warmed up at least 12 hours to prevent breakdown.
4. If the insulation resistance rises above 1 MΩ, the compressor is not faulty.

⚠ Caution:

- **The compressor will not operate unless the power supply phase connection is correct.**
- **Turn on the power at least 12 hours before starting operation.**
Starting operation immediately after turning on the main power switch can result in severe damage to internal parts. Keep the power switch turned on during the operational season.
- **The followings must be checked as well.**
 - The outdoor unit is not faulty. LED on the control board of the outdoor unit flashes when the outdoor unit is faulty.
 - Both the gas and liquid stop valves are completely open.

8-2-2. Test run

(1) Using remote controller

Refer to the indoor unit installation manual.

- Be sure to perform the test run individually for each indoor unit. Make sure each indoor unit operates properly following the installation manual attached to the unit.
If you perform the test run for indoor units connected all at once, faulty connections of the refrigerant pipes and cables cannot be detected.
- * The compressor operation is not available for 3 minutes at least after the power is supplied.
- The compressor can emit noise just after turn on the power supply or in case of low outside air temperature.

About the restart protective mechanism

Once the compressor stops, the restart preventive device operates so the compressor will not operate for 3 minutes to protect the air conditioner.

(2) Using SW4 in outdoor unit

In case of the test run from outdoor unit, all indoor units operate. Therefore, you cannot detect any erroneous connection of refrigerant pipes and the connecting wires. If it aims at detection of any erroneous connection, be sure to carry out the test run from remote controller with reference to "(1) Using remote controller."

SW4-1	ON	Cooling operation
SW4-2	OFF	
SW4-1	ON	Heating operation
SW4-2	ON	

※ After performing the test run, set SW4-1 to OFF.

- A few seconds after the compressor starts, a clanging noise may be heard from the inside of the outdoor unit. The noise is coming from the check valve due to the small difference in pressure in the pipes. The unit is not faulty.
The test run operation mode cannot be changed by DIP switch SW4-2 during the test run. To change the test run operation mode during the test run, stop the test run by DIP switch SW4-1. After changing the test run operation mode, resume the test run by switch SW4-1.

When a test run is started by "Using SW4 in outdoor unit", even if it carries out stop instructions by remote controller, outdoor unit does not stop. A test run is not ended. In this case, please set SW4 in outdoor unit to off.

- After power is supplied or after an operation stops for a while, a small clicking noise may be heard from the inside of the branch box. The electronic expansion valve is opening and closing. The unit is not faulty.

NOTE: Be sure to wait at least 3 minutes after turning on the power supply before setting SW4-1 and SW4-2.
 If the DIP switches are set before 3 minutes has elapsed, the test run may not start.

8-2-3. Test run by outdoor unit SW4

The setting of test run (ON/OFF) and its operation mode (cooling/heating) can be set by SW4 on the controller board of outdoor unit.

- ① Set operation mode (cooling or heating) by SW4-2.
 - ② Start test run by setting SW4-1 to ON (⤴) with the indicated operation mode of SW4-2.
 - ③ Finish test run by setting SW4-1 to OFF (⤵).
- Operation mode cannot be changed by SW4-2 during test run.
 Stop test run to change operation mode by SW4-1, and restart test run by SW4-1 after the mode is changed.
 - Test run automatically stops 2 hours later by 2-hour OFF timer function.
 - Test run can be performed by the remote controller.
 - The remote controller display of test run by outdoor unit is the same as that of test run by remote controller.
 - If test run is set with the outdoor unit, the test run is performed for all indoor units.
 - The remote controller operation becomes unavailable once the test run is set with the outdoor unit.

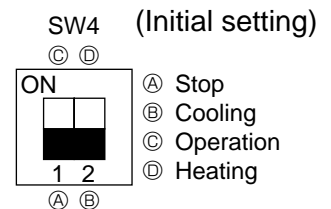

During the test run set with the outdoor unit, operation on/off or operation mode change cannot be performed by the remote controller, and the operation relating to the test run which is made with the outdoor unit will be prior to any other commands from the remote controller. Set the SW4-1 to OFF (⤵) to finish test run. Emergency operation is not available for this model.

8-3. SELF-DIAGNOSIS ACTION TABLE

<Abnormalities detected when the power is put on>

(Note 1) Refer to indoor unit section for code P and code E.

Error Code	Abnormal point and detection method	Case	Judgment and action
None	—	<ul style="list-style-type: none"> ① No voltage is supplied to terminal block (TB1) of outdoor unit. <ul style="list-style-type: none"> a) Power supply breaker is turned off. b) Contact failure or disconnection of power supply terminal c) Open phase (L1 or L2 phase) ② Electric power is not charged to power supply terminal of outdoor power circuit board. <ul style="list-style-type: none"> a) Contact failure of power supply terminal b) Open phase on the outdoor power circuit board ③ Electric power is not supplied to outdoor controller circuit board. <ul style="list-style-type: none"> a) Disconnection of connector (CNDC) ④ Disconnection of reactor (DCL) ⑤ Defective outdoor power circuit board ⑥ Defective outdoor controller circuit board 	<ul style="list-style-type: none"> ① Check following items. <ul style="list-style-type: none"> a) Power supply breaker b) Connection of power supply terminal block. (TB1) c) Connection of power supply terminal block. (TB1) ② Check following items. <ul style="list-style-type: none"> a) Connection of power supply terminal block. (TB1) b) Connection of terminal on outdoor power circuit board. Disconnection of terminal LI or NI. Refer to 8-7. ③ Check connection of the connector (CNDC) on the outdoor controller circuit board. Check connection of the connector (CNDC) on the outdoor power circuit board. Refer to 8-7. ④ Check connection of reactor. (DCL) Check connection of "DCL1" and "DCL2" on the power circuit board. ⑤ Replace outdoor power circuit board. ⑥ Replace controller board (When items above are checked but the units cannot be repaired.)
F3 (5202)	63L connector open Abnormal if 63L connector circuit is open for 3 minutes continuously after power supply 63L: Low-pressure switch	<ul style="list-style-type: none"> ① Disconnection or contact failure of 63L connector on outdoor controller circuit board ② Disconnection or contact failure of 63L ③ 63L is operating due to refrigerant leakage or defective parts. ④ Defective outdoor controller circuit board 	<ul style="list-style-type: none"> ① Check connection of 63L connector on outdoor controller circuit board. Refer to 8-7. ② Check the 63L side of connecting wire. ③ Check refrigerant pressure. Charge additional refrigerant. Check continuity by tester. Replace the parts if the parts are defective. ④ Replace outdoor controller circuit board.
F5 (5201)	63H connector open Abnormal if 63H connector circuit is open for 3 minutes continuously after power supply 63H: High-pressure switch	<ul style="list-style-type: none"> ① Disconnection or contact failure of 63H connector on outdoor controller circuit board ② Disconnection or contact failure of 63H ③ 63H is operating due to defective parts. ④ Defective outdoor controller circuit board 	<ul style="list-style-type: none"> ① Check connection of 63H connector on outdoor controller circuit board. Refer to 8-7. ② Check the 63H side of connecting wire. ③ Check continuity by tester. Replace the parts if the parts are defective. ④ Replace outdoor controller circuit board.
F9 (4119)	2 connector open Abnormal if both 63H and 63L connector circuits are open for 3 minutes continuously after power supply 63H: High-pressure switch 63L: Low-pressure switch	<ul style="list-style-type: none"> ① Disconnection or contact failure of connector (63H,63L) on outdoor controller circuit board. ② Disconnection or contact failure of 63H, 63L ③ 63H and 63L are operating due to defective parts. ④ Defective outdoor controller board 	<ul style="list-style-type: none"> ① Check connection of connector (63H,63L) on outdoor controller circuit board. Refer to 8-7. ② Check the 63H and 63L side of connecting wire. ③ Check continuity by tester. Replace the parts if the parts are defective. ④ Replace outdoor controller circuit board.

Error Code	Abnormal point and detection method	Case	Judgment and action
EA (6844)	Indoor-branch box/branch box-outdoor unit connector miswiring, excessive number of units 1. Outdoor/branch box controller circuit board can automatically check the number of connected indoor units. Abnormal if the number cannot be checked automatically due to miswiring of indoor-branch box/branch box-outdoor unit connecting wire and etc. after power is turned on for 4 minutes.	① Contact failure or miswiring of indoor/outdoor unit connecting wire ② Diameter or length of indoor-branch box/branch box-outdoor unit connecting wire is out of specified capacity. There are 9 or more indoor units in the system. There are 3 or more branch boxes in the system. ③ Defective transmitting receiving circuit of outdoor/branch box controller circuit board ④ Defective transmitting receiving circuit of branch box/indoor controller board ⑤ Defective branch box/indoor power board ⑥ Noise has entered into power supply or indoor-branch box/branch box-outdoor unit connecting wire.	① Check disconnection or looseness or polarity of indoor-branch box/branch box-outdoor unit connecting wire of indoor and outdoor units. ② Check diameter and length of indoor-branch box/branch box-outdoor unit connecting wire. Total wiring length: 55m (outdoor-branch box) (including wiring connecting each branch box unit and between branch box and outdoor unit) Also check if the connection order of flat cable is S1, S2, S3. If the error "EA" is detected, check the number of the indoor units and the branch box in the system. ③~⑤ Turn the power off once, and on again to check. Replace outdoor controller circuit board, branch box controller board, indoor controller board or indoor power board if abnormality occurs again. ⑥ Check transmission path, and remove the cause.
Eb (6845)	Miswiring of indoor-branch box/branch box-outdoor unit connecting wire (converse wiring or disconnection) Outdoor/branch box controller circuit board can automatically set the unit number of indoor units. Abnormal if the indoor unit number can not be set within 4 minutes after power on because of miswiring (converse wiring or disconnection) of indoor-branch box/branch box-outdoor unit connecting wire.	① Contact failure or miswiring of indoor-branch box/branch box-outdoor unit connecting wire ② Diameter or length of indoor-branch box/branch box-outdoor unit connecting wire is out of specified capacity. ④ Defective transmitting receiving circuit of outdoor/branch box controller circuit board ⑤ Defective transmitting receiving circuit of indoor/branch box controller board ⑥ Defective indoor/branch box power board ⑦ Noise has entered into power supply or indoor-branch box/branch box-outdoor unit connecting wire.	* The descriptions above, ①-⑥, are for EA, Eb and EC.
EC (6846)	Start-up time over The unit cannot finish start-up process within 4 minutes after power on.	① Contact failure of indoor-branch box/branch box-outdoor unit connecting wire ② Diameter or length of indoor-branch box/branch box-outdoor unit connecting wire is out of specified capacity. ③ Noise has entered into power supply or indoor-branch box/branch box-outdoor unit connecting wire.	

<Abnormalities detected while unit is operating>

Error Code	Abnormal point and detection method	Case	Judgment and action
U1 (1302)	<p>(1) High-pressure switch (63H) operated Abnormal if high-pressure switch 63H operated (※) during compressor operation. ※ 4.15 MPa [602PSIG]</p> <p>63H: High-pressure switch</p> <p>(2) High pressure (High - pressure sensor 63HS detect)</p> <p>① When high-pressure sensor detects 4.31MPa [625PSIG] or more (or over 4.15MPa [602PSIG] for 3 minutes) (1st detection) during the compressor operation, the compressor stops and restarts operation in 3 minutes.</p> <p>② When the sensor detects 4.31MPa [625PSIG] or more (or over 4.15MPa [602PSIG] for 3 minutes) again (2nd detection) within 30 minutes since the compressor has stopped, the compressor stops again and restarts operation in 3 minutes.</p> <p>③ When the sensor detects 4.31MPa [625PSIG] or more (or over 4.15MPa [602PSIG] for 3 minutes) again (3rd detection) within 30 minutes since the compressor has stopped, the compressor stops again and restarts operation in 3 minutes.</p> <p>④ When the sensor detects 4.31MPa [625PSIG] or more (or over 4.15MPa [602PSIG] for 3 minutes) again (4th detection) within 30 minutes after 3rd compressor stops, it stops abnormally. In this time <U1> is displayed.</p> <p>⑤ When the sensor detects 4.31MPa [625PSIG] or more (or over 4.15MPa [602PSIG] for 3 minutes) after 30 minutes since the compressor has stopped (1st or 2nd or 3rd time), it becomes the 1st detection or the same performance as above-mentioned ①.</p> <p>⑥ It is being delay for abnormal stop during 30 minutes since the compressor has stopped. In this time, check delay code <U1> will be displayed.</p>	<p>1) Short cycle of indoor unit 2) Clogged filter of indoor unit 3) Decreased airflow caused by dirt of indoor fan 4) Dirt of indoor heat exchanger 5) Locked indoor fan motor 6) Malfunction of indoor fan motor 7) Defective operation of stop valve (Not fully opened) 8) Clogged or broken pipe 9) Locked outdoor fan motor 10) Malfunction of outdoor fan motor 11) Short cycle of outdoor unit 12) Dirt of outdoor heat exchanger 13) Decreased airflow caused by defective inspection of outside temperature thermistor (It detects lower temperature than actual temperature.) 14) Disconnection or contact failure of connector (63H) on outdoor controller board 15) Disconnection or contact failure of 63H connection 16) Defective outdoor controller board 17) Defective action of linear expansion valve 18) Malfunction of fan driving circuit 19) Solenoid valve (SV1) performance failure (High-pressure cannot be controlled by SV1) 20) High-pressure sensor defective 21) High-pressure sensor input circuit defective in outdoor controller board</p>	<p>1)~6) Check indoor unit and repair defect.</p> <p>7) Check if stop valve is fully open.</p> <p>8) Check piping and repair defect. 9)~12) Check outdoor unit and repair defect.</p> <p>13) Check the detected temperature of outside temperature thermistor on LED display.</p> <p>14)~16) Put the power off and check F5 is displayed when the power is put again. When F5 is displayed, refer to "Judgment and action" for F5.</p> <p>17) Check linear expansion valve. Refer to 8-6. 18) Replace outdoor controller board. 19) Check the solenoid valve performance.</p> <p>20) Check the high-pressure sensor. 21) Check the high-pressure sensor.</p>

Error Code	Abnormal point and detection method	Case	Judgment and action
U2 (1102)	<p>(1) High discharging temperature Abnormal if discharge temperature thermistor (TH4) exceeds 125°C [257°F] or 110°C [230°F] continuously for 5 minutes. Abnormal if pressure detected by high pressure sensor and converted to saturation temperature exceeds 40°C [104°F] during defrosting and discharge temperature thermistor (TH4) exceeds 110°C [230°F].</p>	<p>① Overheated compressor operation caused by shortage of refrigerant ② Defective operation of stop valve ③ Defective thermistor ④ Defective outdoor controller board ⑤ Defective action of linear expansion valve</p>	<p>① Check intake superheat. Check leakage of refrigerant. Charge additional refrigerant. ② Check if stop valve is fully open. ③④ Turn the power off and check if U3 is displayed when the power is turned on again. When U3 is displayed, refer to "Judgment and action" for U3. ⑤ Check linear expansion valve. Refer to 8-6.</p>
	<p>(2) Refrigerant shortage abnormality</p> <p>① When the conditions of below detecting mode I or II are satisfied (1st detection) during the compressor operation, the compressor stops and restarts operation in 3 minutes. <Detecting mode I > When the below conditions are satisfied completely. 1. Compressor is operating in HEAT mode. 2. Discharge superheat is 70°C [158°F] or more. 3. Difference of outer temperature thermistor (TH7) and outdoor piping temp. thermistor (TH3) applies to the formula of (TH7-TH3)<5 degC [9 degF]. 4. High-pressure pressure sensor is below about 2.04MPa [296PSIG]. <Detecting mode II > When the below conditions are satisfied completely. 1. Compressor is operating. 2. When cooling, discharge superheat is 80°C [144°F] or more. When heating, discharge superheat is 90°C [162°F] or more. High pressure sensor is below about 2.32MPa [337PSIG].</p> <p>② When the conditions of detecting mode I and II are satisfied again (2nd detection) within 30 minutes since the compressor has stopped, it stops abnormally. In this time, <U2> is displayed.</p> <p>③ When the conditions of detecting mode I and II are satisfied again after 30 minutes since the compressor has stopped (1st time), it becomes the 1st detection and same performance as above ①.</p> <p>④ It is being delay for abnormal stop during 30 minutes since the compressor has stopped. In this time, check delay code <U2> will be displayed.</p>	<p>① Gas leakage, Gas shortage ② When heating operation, scant refrigerant operation (When heating, airflow or thermo OFF are mixed-operation, it causes a refrigerant shortage operation.) ③ Ball valve performance failure (Not fully opened.) ④ Error detection of discharge super heat 1) High-pressure sensor defective 2) Discharge temperature thermistor defective 3) Thermistor input circuit defective and high-pressure sensor defective in outdoor controller board ⑤ Error detection of TH7/TH3 1) Thermistor defective 2) Thermistor input circuit defective in outdoor controller board</p>	<p>① Check the refrigerant amount. ② Check the operation condition and refrigerant amount. ③ Check the ball valve is fully opened. ④ 1) Check the ball valve is fully opened. 2) Check the resistance of discharge temperature thermistor. 3) According to "Monitoring function for outdoor unit", set the SW2 and check the high-pressure sensor level. According to "Monitoring function for outdoor unit", set the SW2 and check the discharge temp. thermistor level. When the high-pressure sensor and discharge temp. thermistor are normal, if the above mentioned detecting pressure level and temp. are big different from the actual pressure and temp., replace the outdoor controller board. ⑤ 1) Check the resistance of thermistor. 2) According to "Monitoring function for outdoor unit", set the SW2 and check the outdoor pipe temp. thermistor level. 3) According to "Monitoring function for outdoor unit", set the SW2 and check the outer temp. thermistor level.</p>
U3 (5104)	<p>Open/short circuit of discharge temperature thermistor (TH4) Abnormal if open (3°C [37°F] or less) or short (217°C [423°F] or more) is detected during compressor operation. (Detection is inoperative for 10 minutes of compressor starting process and for 10 minutes after and during defrosting.)</p>	<p>① Disconnection or contact failure of connector (TH4) on the outdoor controller circuit board ② Defective thermistor ③ Defective outdoor controller circuit board</p>	<p>① Check connection of connector (TH4) on the outdoor controller circuit board. Check breaking of the lead wire for thermistor (TH4). Refer to 8-6. ② Check resistance value of thermistor (TH4) or temperature by microprocessor. (Thermistor/TH4: Refer to 8-6.) (SW2 on A-Control Service Tool: Refer to 8-8.) ③ Replace outdoor controller board.</p>

Error Code	Abnormal point and detection method	Case	Judgment and action																											
U4 (TH3:5105) (TH7:5106) (TH8:5110) (63HS:5201) (TH-A~E) :5131	(1) Open/short circuit in the outdoor unit thermistors (TH3, TH7, and TH8) and branch box's thermistors(TH-A~E) Abnormal if open or short circuit is detected while the compressor is operating. Open detection of thermistors TH3 is inoperative for 10 seconds to 10 minutes after compressor starting and 10 minutes after recovery from defrosting and during defrosting. *Check which unit has abnormality in its thermistor by switching the mode of SW2. (Refer to 8-8.) Open/short circuit in the branch box thermistor. (TH-A~TH-E)	①One or more connectors on outdoor controller circuit board (TH3, TH7 and TH8) and branch box controller board (TH-A~E) have contact failure or disconnection. ②Defective thermistor ③Outdoor controller circuit board is defective.	①Check the connector's contact and the electric wires of thermistor. ②Check the resistance value of thermistors or the temperatures by referring to the section of "Monitoring function for outdoor unit". (Convert modes by SW2.) ③Replace the whole outdoor controller board.																											
	<table border="1"> <thead> <tr> <th colspan="2">Thermistors</th> <th>Open detection</th> <th>Short detection</th> </tr> <tr> <th>Symbol</th> <th>Name</th> <td></td> <td></td> </tr> </thead> <tbody> <tr> <td>TH3</td> <td>Thermistor <Outdoor pipe></td> <td>- 40°C [- 40°F] or below</td> <td>90°C [194°F] or above</td> </tr> <tr> <td>TH7</td> <td>Thermistor <Outdoor></td> <td>- 40°C [- 40°F] or below</td> <td>90°C [194°F] or above</td> </tr> <tr> <td>TH8</td> <td>Internal thermistor <Heatsink></td> <td>- 35°C [- 30°F] or below</td> <td>170°C [338°F] or above</td> </tr> <tr> <th colspan="4">Branch box unit</th> </tr> <tr> <td>TH-A~E (Room A-E)</td> <td>Thermistor (Gas pipe temperature detection)</td> <td>- 40°C [- 40°F] or below</td> <td>90°C [194°F] or above</td> </tr> </tbody> </table>	Thermistors		Open detection	Short detection	Symbol	Name			TH3	Thermistor <Outdoor pipe>	- 40°C [- 40°F] or below	90°C [194°F] or above	TH7	Thermistor <Outdoor>	- 40°C [- 40°F] or below	90°C [194°F] or above	TH8	Internal thermistor <Heatsink>	- 35°C [- 30°F] or below	170°C [338°F] or above	Branch box unit				TH-A~E (Room A-E)	Thermistor (Gas pipe temperature detection)	- 40°C [- 40°F] or below	90°C [194°F] or above	
Thermistors		Open detection	Short detection																											
Symbol	Name																													
TH3	Thermistor <Outdoor pipe>	- 40°C [- 40°F] or below	90°C [194°F] or above																											
TH7	Thermistor <Outdoor>	- 40°C [- 40°F] or below	90°C [194°F] or above																											
TH8	Internal thermistor <Heatsink>	- 35°C [- 30°F] or below	170°C [338°F] or above																											
Branch box unit																														
TH-A~E (Room A-E)	Thermistor (Gas pipe temperature detection)	- 40°C [- 40°F] or below	90°C [194°F] or above																											
	(2) High-Pressure sensor (63HS) abnormality ①When detected pressure in high-pressure sensor is 1MPa [145PSIG] or less during the operation, the compressor stops and restarts operation in 3 minutes. ②When the detected pressure is 1MPa [145PSIG] or less at just before of restarting, the compressor stops abnormally. In this time, <U4> is displayed. ③For 3 minutes after the compressor stops, the unit delays abnormal stop. Then, the outdoor unit address No. and check delay code <U4> blinks alternately on the 7 SEG digital display. ④For 3 minutes after starting compressor, for defrosting or for 3 minutes after recovery from defrosting, abnormality is not determined as abnormality.	①High-pressure sensor failure ②Internal pressure decrease by gas leakage ③Connector contact failure disconnection ④Controller board input circuit failure	① Check the high-pressure sensor. ② Check the internal pressure. ③ Check the high-pressure sensor. ④ Check the outdoor controller board																											
U5 (4230)	Abnormal temperature of heatsink Abnormal if heatsink thermistor(TH8) detects temperature indicated 93 °C [200 °F]	① The outdoor fan motor is locked. ② Failure of outdoor fan motor ③ Air flow path is clogged. ④ Rise of ambient temperature ⑤ Defective thermistor ⑥ Defective input circuit of outdoor power circuit board ⑦ Failure of outdoor fan drive circuit	①② Check outdoor fan. ③ Check air flow path for cooling. ④ Check if there is something which causes temperature rise around outdoor unit. (Upper limit of ambient temperature is 46°C [115°F].) Turn off power, and on again to check if U5 is displayed within 30 minutes. If U4 is displayed instead of U5, follow the action to be taken for U4. ⑤ Check resistance value of thermistor (TH8) or temperature by microprocessor. (Thermistor/TH8: Refer to 8-6.) (SW2 on A-Control Service Tool: Refer to 8-8.) ⑥ Replace outdoor power circuit board. ⑦ Replace outdoor controller circuit board.																											
U6 (4250)	Abnormality of power module Check abnormality by driving power module in case overcurrent is detected. (UF or UP error condition)	① Outdoor stop valve is closed. ② Decrease of power supply voltage ③ Looseness, disconnection or converse of compressor wiring connection ④ Defective compressor ⑤ Defective outdoor power circuit board	① Open stop valve. ② Check facility of power supply. ③ Correct the wiring (U-V-W phase) to compressor. Refer to 8-7. ④ Check compressor referring to 8-6. ⑤ Replace outdoor power circuit board.																											

Error Code	Abnormal point and detection method	Case	Judgment and action
U7 (1520)	<p>(1) Too low superheat due to low discharge temperature Abnormal if discharge superheat is continuously detected -15°C [-27°F] or less even though linear expansion valve has minimum open pulse after compressor starts operating for 10 minutes.</p> <p>(2) Erroneous connection of refrigerant pipes or the connecting wires Consider the stopping indoor unit abnormal if condenser/evaporator temperature thermistor (TH5 or RT12) detects -5°C [23°F] or below continuously for 5 minutes during a compressor's operation in cooling mode.</p>	<p>① Disconnection or loose connection of discharge temperature thermistor. (TH4) ② Defective holder of discharge temperature thermistor</p> <p>① Failure in piping / wiring ② Pipe (liquid) is clogged or crushed.</p>	<p>①② Check the installation conditions of discharge temperature thermistor (TH4).</p> <p>① Check piping / wiring between branch box and indoor unit. Refer to "Test run (Using remote controller)". ② Check the pipe for refrigerant and change the wrong parts.</p>
U8 (4400)	<p>Outdoor fan motor The outdoor fan motor is considered to be abnormal if the rotational frequency of fan motor is abnormal when detected during operation. Fan motor rotational frequency is abnormal if;</p> <ul style="list-style-type: none"> • 100 rpm or below detected continuously for 15 seconds at 26°C [79°F] or more outside air temperature • 50 rpm or below or 1500 rpm or more detected continuously for 1 minute. 	<p>① Failure in the operation of the DC fan motor ② Failure in the outdoor circuit controller board</p>	<p>① Check or replace the DC fan motor. ② Check the voltage of the outdoor circuit controller board during operation. ③ Replace the outdoor circuit controller board. (when the failure is still indicated even after performing the remedy ① above.)</p>
U9 (4220)	<p>Overvoltage or voltage shortage and abnormal synchronous signal to main circuit</p> <p>Abnormal if any of followings are detected during compressor operation;</p> <ul style="list-style-type: none"> • Decrease of DC bus voltage to 310V • Instantaneous decrease of DC bus voltage to 200V • Increase of DC bus voltage to 400V • Decrease of input current of outdoor unit to 0.5A only if operation frequency is more than or equal to 40Hz or compressor current is more than or equal to 5A. 	<p>① Decrease of power supply voltage ② Disconnection of compressor wiring ③ Defective 52C</p> <p>④ Disconnection or loose connection of CNAF ⑤ Defective 52C drive circuit of outdoor controller circuit board</p> <p>⑥ Disconnection or loose connection of CN2 on the outdoor power circuit board</p>	<p>① Check the facility of power supply. ② Correct the wiring (U-V-W phase) to compressor. Refer to 8-7. ③ Replace power circuit board.</p> <p>④ Check CNAF wiring. ⑤ Replace outdoor controller circuit board. (12V DC output) ⑥ Check CN2 wiring on the outdoor power circuit board. Refer to 8-7.</p>
UF (4100)	<p>Compressor overcurrent interruption (When compressor locked) Abnormal if overcurrent of DC bus or compressor is detected within 30 seconds after compressor starts operating.</p>	<p>① Stop valve is closed. ② Decrease of power supply voltage ③ Looseness, disconnection or converse of compressor wiring connection ④ Defective compressor ⑤ Defective outdoor power board</p>	<p>① Open stop valve. ② Check facility of power supply. ③ Correct the wiring (U-V-W phase) to compressor. Refer to 8-7. ④ Check compressor. Refer to 8-6. ⑤ Replace outdoor power circuit board.</p>
UH (5300)	<p>Current sensor error Abnormal if current sensor detects -1.5A to 1.5A during compressor operation. (This error is ignored in case of test run mode.)</p> <p>Abnormal if input current exceeds 38 A or 34A continuously 10 seconds. (Current sensor on noise filter board detects input current)</p>	<p>① Disconnection of compressor wiring ② Defective circuit of current sensor on outdoor power circuit board</p> <p>① Decrease of power supply voltage</p>	<p>① Correct the wiring (U-V-W phase) to compressor. Refer to 8-7. ② Replace outdoor power circuit board.</p> <p>① Check the facility of power supply.</p>

Error Code	Abnormal point and detection method	Case	Judgment and action
UL (1300)	Low pressure (63L operated) Abnormal if 63L is operated (under -0.03MPa [-4.35PSIG]) during compressor operation. 63L: Low-pressure switch	<ul style="list-style-type: none"> ① Stop valve of outdoor unit is closed during operation. ② Disconnection or loose connection of connector (63L) on outdoor controller board ③ Disconnection or loose connection of 63L ④ Defective outdoor controller board ⑤ Leakage or shortage of refrigerant ⑥ Malfunction of linear expansion valve 	<ul style="list-style-type: none"> ① Check stop valve. ②~④ Turn the power off and on again to check if F3 is displayed on restarting. If F3 is displayed, follow the F3 processing direction. ⑤ Correct to proper amount of refrigerant. ⑥ Check linear expansion valve. Refer to 8-6.
UP (4210)	Compressor overcurrent interruption Abnormal if overcurrent DC bus or compressor is detected after compressor starts operating for 30 seconds.	<ul style="list-style-type: none"> ① Stop valve of outdoor unit is closed. ② Decrease of power supply voltage ③ Looseness, disconnection or converse of compressor wiring connection ④ Defective fan of indoor/outdoor units ⑤ Short cycle of indoor/outdoor units ⑥ Defective input circuit of outdoor controller board ⑦ Defective compressor 	<ul style="list-style-type: none"> ① Open stop valve. ② Check facility of power supply. ③ Correct the wiring (U-V-W phase) to compressor. Refer to 8-7. ④ Check indoor/outdoor fan. ⑤ Solve short cycle. ⑥ Replace outdoor controller circuit board. ⑦ Check compressor. Refer to 8-6. * Before the replacement of the outdoor controller circuit board, disconnect the wiring for compressor from the outdoor power circuit board and check the output voltage among phases, U, V, W, during test run. No defect on board if voltage among phases (U-V, V-W and W-U) is same. Make sure to perform the voltage check with same performing frequency.
E0 (No display)	Remote controller communication error (Signal receiving error) (1) Abnormal if any signal from IC of refrigerant address "0" could not be normally received for 3 minutes. (2) Abnormal if sub remote controller could not receive any signal for 2 minutes.	<ul style="list-style-type: none"> ① Defective communication circuit of remote controller ② Defective communication circuit of indoor controller board of refrigerant address "0" ③ Noise has entered into transmission line of remote controller. ④ All remote controllers are set as "sub" remote controller. In this case, E4 is displayed at outdoor LED, and E0 is displayed at remote controller. 	<ul style="list-style-type: none"> ①~③ Diagnose remote controller. Take actions as follows according to diagnosis result. a) When "RC OK" is displayed, remote controllers have no problem. Turn the power off, and on again to check. If, "PLEASE WAIT" is displayed for 4 minutes or more, replace indoor controller board. b) When "RC NG" is displayed, replace remote controller. c) When "RC E3" or "ERC 00-66" is displayed, noise may be causing abnormality. ④ Set a remote controller to main, and the other to sub. * The descriptions above, ①-③, are for E0 and E3.
E3 (No display)	Remote controller communication error (Transmitting error) (1) Abnormal if sub remote controller could not find blank of transmission path for 6 seconds. (2) Abnormal if remote controller could not finish transmitting 30 times continuously.	<ul style="list-style-type: none"> ① Defective communication circuit of remote controller ② Noise has entered into transmission line of remote controller. ③ Two remote controllers are set as "main." (In case of 2 remote controllers) 	
E8 (6840)	Indoor - branch box/branch box - outdoor unit communication error (Signal receiving error) (Branch box/outdoor unit) (1) Abnormal if branch box/outdoor controller circuit board could not receive anything normally for 3 minutes.	<ul style="list-style-type: none"> ① Contact failure of indoor/outdoor unit connecting wire ② Defective communication circuit of branch box/outdoor controller circuit board ③ Defective communication circuit of indoor/branch box controller board ④ Noise has entered into indoor-branch box/branch box-outdoor unit connecting wire. 	<ul style="list-style-type: none"> ① Check disconnection or looseness of indoor-branch box/branch box-outdoor unit connecting wire of indoor or branch box or outdoor units. ②~④ Turn the power off, and on again to check. Replace indoor controller board or branch controller board or outdoor controller circuit board if abnormality is displayed again.

Error Code	Abnormal point and detection method	Case	Judgment and action
E9 (6841)	<p>Indoor - branch box/branch box - outdoor unit communication error (Transmitting error) (Branch box/outdoor unit)</p> <p>(1) Abnormal if "0" receiving is detected 30 times continuously though branch box/outdoor controller circuit board has transmitted "1".</p> <p>(2) Abnormal if branch box/outdoor controller circuit board could not find blank of transmission path for 3 minutes.</p>	<p>① Indoor-branch box/branch box-outdoor unit connecting wire has contact failure.</p> <p>② Defective communication circuit of outdoor controller circuit board</p> <p>③ Noise has entered power supply.</p> <p>④ Noise has entered Indoor-branch box/branch box-outdoor unit connecting wire.</p>	<p>① Check disconnection or looseness of indoor-branch box/branch box-outdoor unit connecting wire.</p> <p>②-④ Turn the power off, and on again to check. Replace outdoor controller circuit board if abnormality is displayed again.</p>
EF (6607 or 6608)	<p>Non defined error code</p> <p>This code is displayed when non defined error code is received.</p>	<p>① Noise has entered transmission wire of remote controller.</p> <p>② Noise has entered Indoor-branch box/branch box-outdoor unit connecting wire.</p> <p>③ Model name of remote controller is PAR-S25A.</p>	<p>①② Turn the power off, and on again to check. Replace indoor controller board or branch controller board or outdoor controller circuit board if abnormality is displayed again.</p> <p>③ Replace remote controller with MA remote controller.</p>
Ed (0403)	<p>Serial communication error</p> <p>1. Abnormal if serial communication between outdoor controller circuit board and outdoor power circuit board is defective.</p>	<p>① Breaking of wire or contact failure of connector CN2 between the outdoor controller circuit board and the outdoor power circuit board</p> <p>② Breaking of wire or contact failure of connector CN4 between the outdoor controller circuit board and the outdoor power circuit board</p> <p>③ Defective communication circuit of outdoor power circuit board</p> <p>④ Defective communication circuit of outdoor controller circuit board for outdoor power circuit board</p>	<p>①② Check connection of each connector CN2 and CN4 between the outdoor controller circuit board and the outdoor power circuit board.</p> <p>③ Replace outdoor power circuit board.</p> <p>④ Replace outdoor controller circuit board.</p>
PA (2520)	<p>Forced compressor stop.</p> <p>(Overlap multi function of drain pump in indoor unit and linear expansion valve in branch box.)</p> <p>When condition which the outdoor unit is stopped forcibly consists, or the drain sensor detects continuously to go under water 5 times, and also detects "[liquid pipe temperature-suction temperature] ≤ -10°C [-18°F]" for 30 minutes continuously, the indoor unit stops abnormally (however, fan operates by normal control) that indoor unit and excluding [Fan mode or OFF] in same refrigerant system. Also, the outdoor unit which is connected to that indoor unit with refrigerant system stops abnormality (compressor is inhibited to operation). In this time, <PA> is displayed.</p>	<p>① Drain pump trouble</p> <p>② Drain defective</p> <ul style="list-style-type: none"> · Drain pump clogging · Drain pipe clogging <p>③ Open circuit of drain sensor side heater</p> <p>④ Contact failure of drain sensor connector</p> <p>⑤ Dew condensation on drain sensor</p> <ul style="list-style-type: none"> · Drain water descends along lead wire. · Drain water waving due to filter clogging <p>⑥ Indoor controller board defective</p> <ul style="list-style-type: none"> · Drain pump drive circuit failure · Drain heater output circuit failure <p>⑦ Both of above mentioned ①-⑥ and the linear expansion valve full closed failure happens synchronistically.</p>	<p>① Check the drain pump. Performance</p> <p>② Please confirm whether water can be drained.</p> <p>③ Confirm the resistance of the drain sensor side heater.</p> <p>④ Check the connector contact failure.</p> <p>⑤ Check the drain sensor leadwire mounted. Check the filter clogging.</p> <p>⑥ If the above mentioned checkpoints has any problem, replace the indoor controller board.</p> <p>⑦ Check whether the indoor linear expansion valve leaks or not.</p>

8-4. TROUBLESHOOTING BY INFERIOR PHENOMENA

Phenomena	Factor	Countermeasure
1. Remote controller display works normally and the unit performs cooling operation, however, the capacity cannot be fully obtained. (The air does not cool well.)	<ul style="list-style-type: none"> ①Refrigerant shortage ②Filter clogging ③Heat exchanger clogging ④Air duct short cycle 	<ul style="list-style-type: none"> ① If refrigerant leaks, discharging temperature rises and LEV opening increases. Inspect leakage by checking the temperature and opening. Check pipe connections for gas leakage. ② Open intake grille and check the filter. Clean the filter by removing dirt or dust on it. ③ If the filter is clogged, indoor pipe temperature rises and discharging pressure increases. Check if heat exchanger is clogged by inspecting discharging pressure. Clean the heat exchanger. ④ Remove the blockage.
2. Remote controller display works normally and the unit performs heating operation, however, the capacity cannot be fully obtained.	<ul style="list-style-type: none"> ①Linear expansion valve fault Opening cannot be adjusted well due to linear expansion valve fault. ②Refrigerant shortage ③Lack of insulation for refrigerant piping ④Filter clogging ⑤Heat exchanger clogging ⑥Air duct short cycle ⑦Bypass circuit of outdoor unit fault 	<ul style="list-style-type: none"> ① Discharging temperature and indoor heat exchanger temperature does not rise. Inspect the failure by checking discharging pressure. Replace linear expansion valve. ② If refrigerant leaks, discharging temperature rises and LEV opening increases. Inspect leakage by checking the temperature and opening. Check pipe connections for gas leakage. ③ Check the insulation. ④ Open intake grille and check the filter. Clean the filter by removing dirt or dust on it. ⑤ If the filter is clogged, indoor pipe temperature rises and discharging pressure increases. Check if heat exchanger is clogged by inspecting discharging pressure. Clean the heat exchanger. ⑥ Remove the blockage. ⑦ Check refrigerant system during operation.
3.①For 3 minutes after temperature adjuster turns off, the compressor will not start operating even if temperature adjuster is turned on. ②For 3 minutes after temperature adjuster turns on, the compressor will not stop operating even if temperature adjuster is turned off. (Compressor stops operating immediately when turning off by the remote controller.)	<ul style="list-style-type: none"> ①②Normal operation (For protection of compressor) 	<ul style="list-style-type: none"> ①②Normal operation

8-5. SPECIAL FUNCTIONS

8-5-1. Low noise mode (on-site modification) (Fig. 8-1)

By performing the following modification, operation noise of the outdoor unit can be reduced by about 3-4 dB. The low noise mode will be activated when a commercially available timer or the contact input of an ON/OFF switch is added to the CNDM connector (optional parts) on the control board of the outdoor unit.

- The capacity may be insufficient according to the outdoor temperature and conditions, etc.
- ① Complete the circuit as shown when using the external input adapter (PAC-SC36NA). (Optional parts)

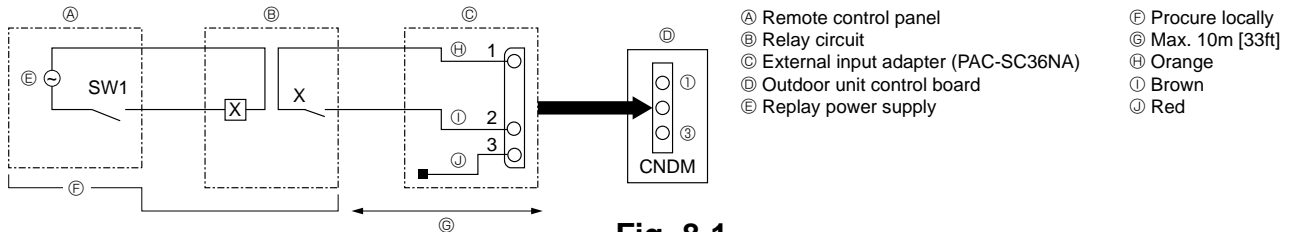

Fig. 8-1

8-5-2. Demand function (on-site modification) (Fig. 8-2)

- It is possible to reduce electricity consumption within a range from 0 to 100 % by performing the following on-site installation. The demand function can be enabled by adding a commercially available input contact point ON/OFF switch to the CNDM connector (the contact point demand input, optional parts).

- Incorporate the "Adapter for external input (PAC-SC36NA)" into the circuit as shown in the diagram below.
- By switching SW7-1 on the control circuit board for the outdoor unit, the following power consumption restrictions (compared to rated power) can be set.

SW7-1	Power consumption when SW2 is on
OFF	0% (Forced compressor stop)
ON	50%

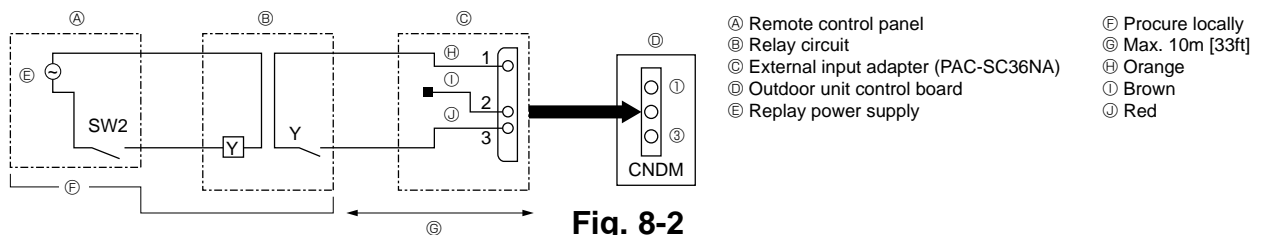

Fig. 8-2

8-5-3. Error and compressor operation monitoring function (CN51)

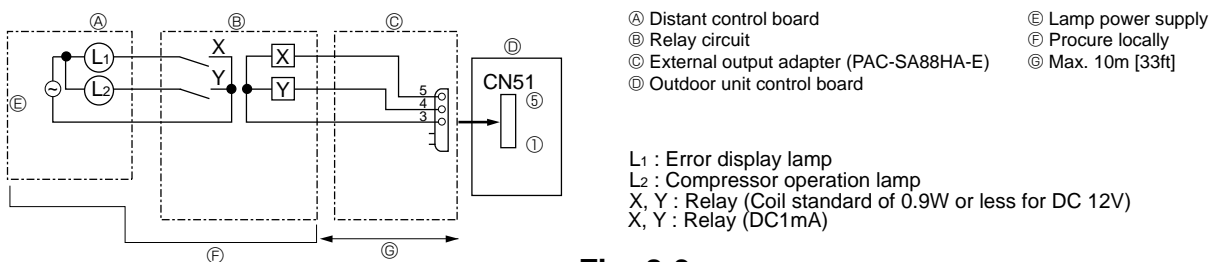
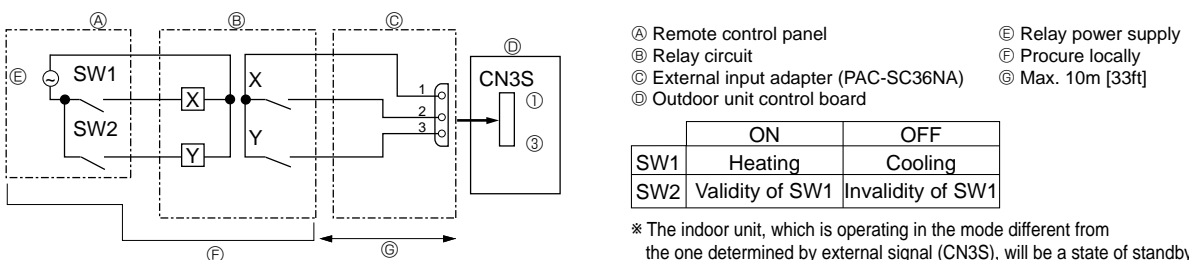

Fig. 8-3

8-5-4. Auto change over - Operation mode locking function by external signal (CN3S)



	ON	OFF
SW1	Heating	Cooling
SW2	Validity of SW1	Invalidity of SW1

- * The indoor unit, which is operating in the mode different from the one determined by external signal (CN3S), will be a state of standby.
- * The setting becomes effective when the outdoor unit is under stop.
- * The operation mode specified by test run will be prior to the mode of this function.

Fig. 8-4

8-6. HOW TO CHECK THE PARTS

OUTDOOR UNIT : MXZ-8B48NA

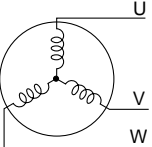
Parts name	Check points												
Thermistor (TH3) <Outdoor pipe> Thermistor (TH4) <Discharge> Thermistor (TH6) <2-phase pipe> Thermistor (TH7) <Outdoor>	Disconnect the connector then measure the resistance with a tester. (At the ambient temperature 10°C~30°C, 50°F~86°F) <table border="1" style="margin-left: 20px;"> <thead> <tr> <th></th> <th>Normal</th> <th>Abnormal</th> </tr> </thead> <tbody> <tr> <td>TH4</td> <td>160kΩ~410kΩ</td> <td rowspan="3">Open or short</td> </tr> <tr> <td>TH3</td> <td rowspan="2">4.3kΩ~9.6kΩ</td> </tr> <tr> <td>TH6</td> </tr> <tr> <td>TH7</td> <td></td> <td></td> </tr> </tbody> </table>		Normal	Abnormal	TH4	160kΩ~410kΩ	Open or short	TH3	4.3kΩ~9.6kΩ	TH6	TH7		
	Normal	Abnormal											
TH4	160kΩ~410kΩ	Open or short											
TH3	4.3kΩ~9.6kΩ												
TH6													
TH7													
Fan motor(MF1,MF2)	Refer to next page.												
Solenoid valve coil <Four-way valve> (21S4)	Measure the resistance between the terminals with a tester. (At the ambient temperature 20°C, 68°F) <table border="1" style="margin-left: 20px;"> <thead> <tr> <th>Normal</th> <th>Abnormal</th> </tr> </thead> <tbody> <tr> <td>1435 ± 150Ω</td> <td>Open or short</td> </tr> </tbody> </table>	Normal	Abnormal	1435 ± 150Ω	Open or short								
Normal	Abnormal												
1435 ± 150Ω	Open or short												
Motor for compressor (MC) 	Measure the resistance between the terminals with a tester. (Winding temperature 20°C, 68°F) <table border="1" style="margin-left: 20px;"> <thead> <tr> <th>Normal</th> <th>Abnormal</th> </tr> </thead> <tbody> <tr> <td>0.188Ω</td> <td>Open or short</td> </tr> </tbody> </table>	Normal	Abnormal	0.188Ω	Open or short								
Normal	Abnormal												
0.188Ω	Open or short												
Solenoid valve coil <Bypass valve> (SV1)	Measure the resistance between the terminals with a tester. (At the ambient temperature 20°C, 68°F) <table border="1" style="margin-left: 20px;"> <thead> <tr> <th>Normal</th> <th>Abnormal</th> </tr> </thead> <tbody> <tr> <td>1327 ± 10Ω</td> <td>Open or short</td> </tr> </tbody> </table>	Normal	Abnormal	1327 ± 10Ω	Open or short								
Normal	Abnormal												
1327 ± 10Ω	Open or short												
Solenoid valve coil <Bypass valve> (SV2)	Measure the resistance between the terminals with a tester. (At the ambient temperature 20°C, 68°F) <table border="1" style="margin-left: 20px;"> <thead> <tr> <th>Normal</th> <th>Abnormal</th> </tr> </thead> <tbody> <tr> <td>1450 ± 150Ω</td> <td>Open or short</td> </tr> </tbody> </table>	Normal	Abnormal	1450 ± 150Ω	Open or short								
Normal	Abnormal												
1450 ± 150Ω	Open or short												

Check method of DC fan motor (fan motor / outdoor controller circuit board)

① Notes

- High voltage is applied to the connector (CNF1, 2) for the fan motor. Pay attention to the service.
- Do not pull out the connector (CNF1, 2) for the motor with the power supply on.
(It causes trouble of the outdoor controller circuit board and fan motor.)

② Self check

Symptom : The outdoor fan cannot turn around.

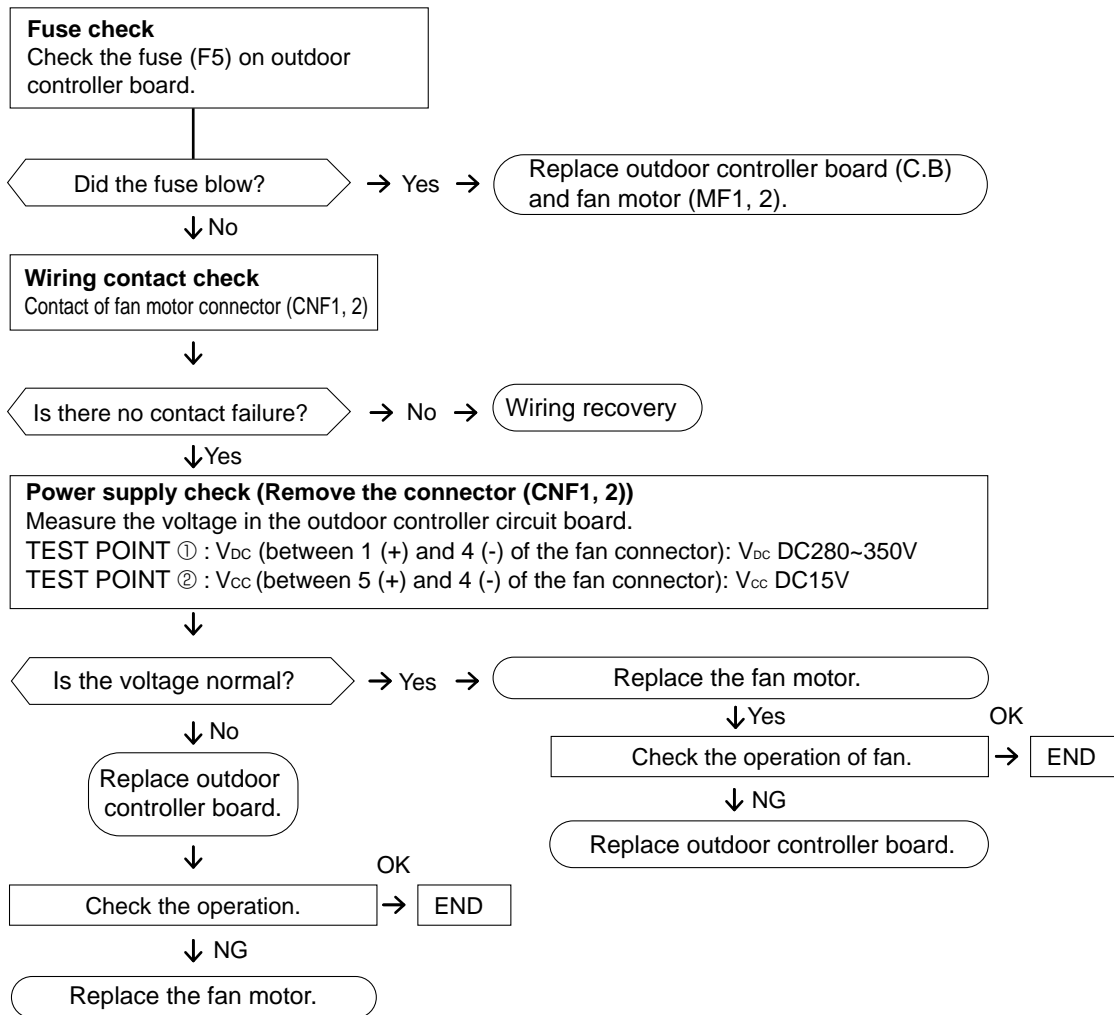

<HIGH PRESSURE SENSOR>

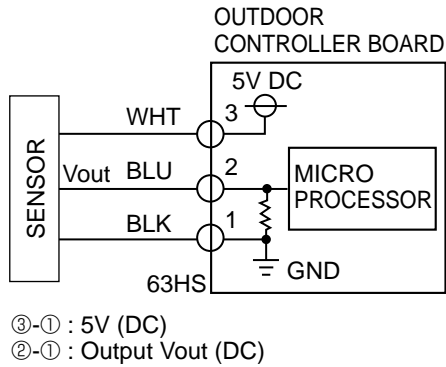
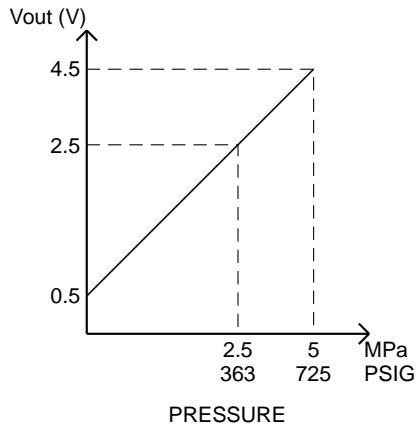

<Thermistor feature chart>

Low temperature thermistors

- Thermistor <Outdoor pipe> (TH3)
- Thermistor <2-phase pipe> (TH6)
- Thermistor <Outdoor> (TH7)
- Thermistor <Gas pipe> (TH-A~TH-E).....Branch box

Thermistor R0 = 15kΩ ± 3%
B constant = 3480 ± 2%

$$R_t = 15 \exp\left\{3480 \left(\frac{1}{273+t} - \frac{1}{273}\right)\right\} \quad t : ^\circ\text{C} = (^\circ\text{F} - 32) / 1.8$$

0°C [32°F]	15kΩ
10°C [50°F]	9.6kΩ
20°C [68°F]	6.3kΩ
25°C [77°F]	5.2kΩ
30°C [86°F]	4.3kΩ
40°C [104°F]	3.0kΩ

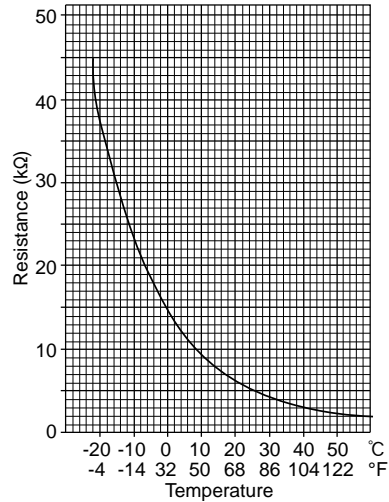

High temperature thermistor

- Thermistor <Discharge> (TH4)

Thermistor R120 = 7.465kΩ ± 2%
B constant = 4057 ± 2%

$$R_t = 7.465 \exp\left\{4057 \left(\frac{1}{273+t} - \frac{1}{393}\right)\right\} \quad t : ^\circ\text{C} = (^\circ\text{F} - 32) / 1.8$$

20°C [68°F]	250kΩ	70°C [158°F]	34kΩ
30°C [86°F]	160kΩ	80°C [176°F]	24kΩ
40°C [104°F]	104kΩ	90°C [194°F]	17.5kΩ
50°C [122°F]	70kΩ	100°C [212°F]	13.0kΩ
60°C [140°F]	48kΩ	110°C [230°F]	9.8kΩ

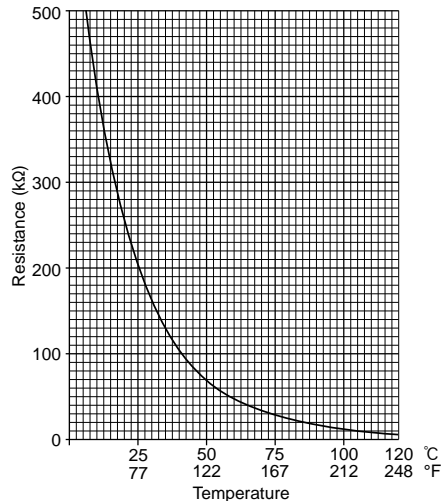

**BRANCH BOX : PAC-AKA51BC
PAC-AKA31BC**

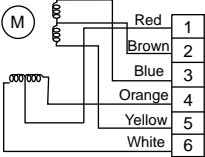
Parts name	Check points																	
Thermistor (TH-A~E) <Gas pipe>	Disconnect the connector then measure the resistance with a tester. (At the ambient temperature 10°C ~30°C , 50°F~86°F) <table border="1" data-bbox="421 495 1241 584"> <thead> <tr> <th colspan="2" data-bbox="421 495 831 533">Normal</th> <th colspan="2" data-bbox="831 495 1241 533">Abnormal</th> </tr> </thead> <tbody> <tr> <td colspan="2" data-bbox="421 533 831 584">4.3kΩ~9.6kΩ</td> <td colspan="2" data-bbox="831 533 1241 584">Open or short</td> </tr> </tbody> </table>				Normal		Abnormal		4.3kΩ~9.6kΩ		Open or short							
Normal		Abnormal																
4.3kΩ~9.6kΩ		Open or short																
Linear expansion valve (LEV-A~E) 	Disconnect the connector then measure the resistance with a tester. (Winding temperature 20°C , 68°F) <table border="1" data-bbox="421 685 1241 819"> <thead> <tr> <th colspan="4" data-bbox="421 685 968 730">Normal</th> <th colspan="1" data-bbox="968 685 1241 730">Abnormal</th> </tr> </thead> <tbody> <tr> <td data-bbox="421 730 558 775">Red - White</td> <td data-bbox="558 730 695 775">Red - Orange</td> <td data-bbox="695 730 833 775">Brown - Yellow</td> <td data-bbox="833 730 968 775">Brown - Blue</td> <td data-bbox="968 730 1241 819" rowspan="2">Open or short</td> </tr> <tr> <td colspan="4" data-bbox="421 775 968 819">46 ± 4Ω</td> </tr> </tbody> </table>				Normal				Abnormal	Red - White	Red - Orange	Brown - Yellow	Brown - Blue	Open or short	46 ± 4Ω			
Normal				Abnormal														
Red - White	Red - Orange	Brown - Yellow	Brown - Blue	Open or short														
46 ± 4Ω																		

Linear expansion valve (LEV) in Branch box

(1) Operation summary of the linear expansion valve

- Linear expansion valve open/close through stepping motor after receiving the pulse signal from the branch box controller board.
 - Valve position can be changed in proportion to the number of pulse signal.
- <Connection between the branch box controller board and the linear expansion valve>

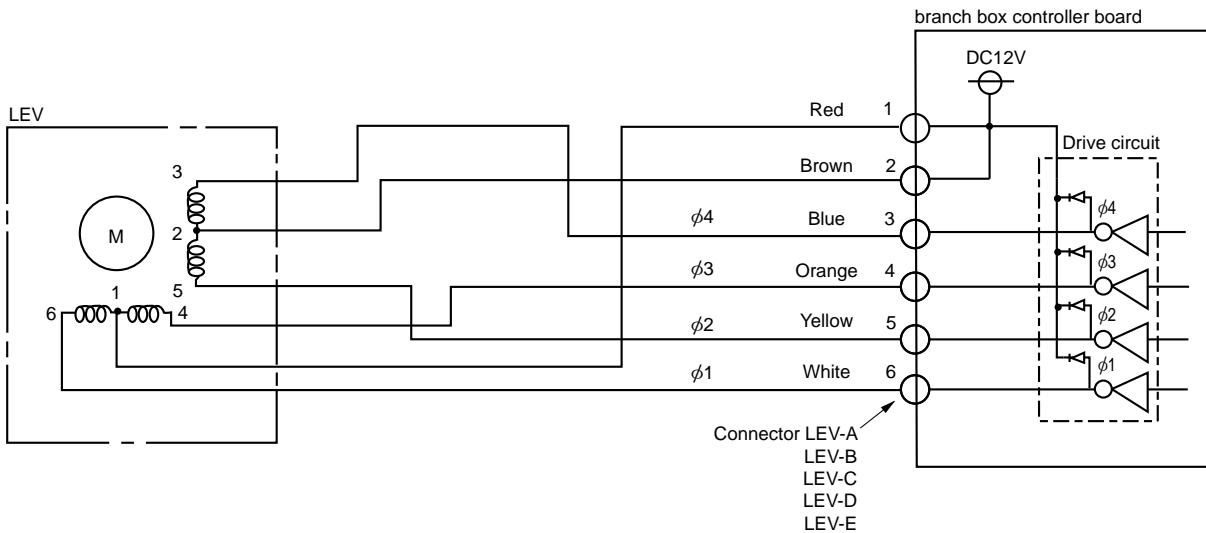

<Output pulse signal and the valve operation>

Output (Phase)	Output							
	1	2	3	4	5	6	7	8
φ1	ON	ON	OFF	OFF	OFF	OFF	OFF	ON
φ2	OFF	ON	ON	ON	OFF	OFF	OFF	OFF
φ3	OFF	OFF	OFF	ON	ON	ON	OFF	OFF
φ4	OFF	OFF	OFF	OFF	OFF	ON	ON	ON

Opening a valve : 8 → 7 → 6 → 5 → 4 → 3 → 2 → 1 → 8
 Closing a valve : 1 → 2 → 3 → 4 → 5 → 6 → 7 → 8 → 1
 The output pulse shifts in above order.

- When linear expansion valve operation stops, all output phase become OFF.

(2) Linear expansion valve operation

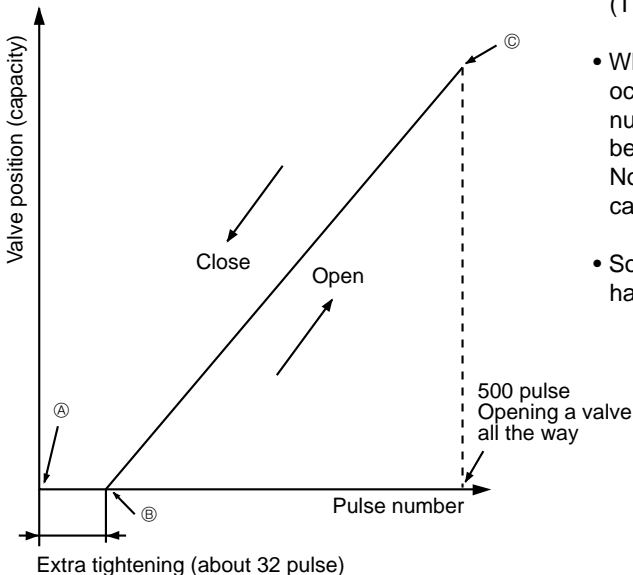

- When the switch is turned on, 700 pulse closing valve signal will be sent till it goes to ① point in order to define the valve position. (The pulse signal is being sent for about 20 seconds.)
- When the valve moves smoothly, there is no sound or vibration occurring from the linear expansion valve : however, when the pulse number moves from ③ to ① or when the valve is locked, sound can be heard. No sound is heard when the pulse number moves from ③ to ① in case coil is burnt out or motor is locked by open-phase.
- Sound can be detected by placing the ear against the screw driver handle while putting the screw driver to the linear expansion valve.

(3) How to attach and detach the coil of linear expansion valve

<Composition>

Linear expansion valve is separable into the main body and the coil as shown in the diagram below.

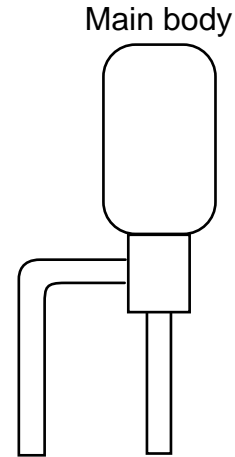
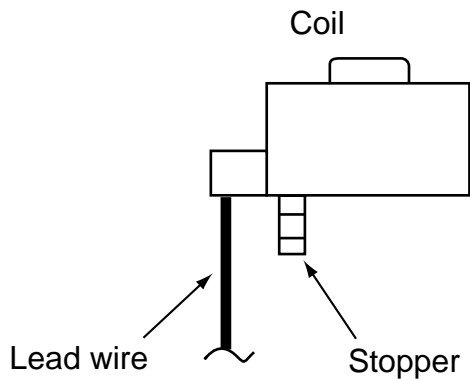

<How to detach the coil>

Hold the lower part of the main body (shown as A) firmly so that the main body does not move and detach the coil by pulling it upward.

Be sure to detach the coil holding main body firmly. Otherwise pipes can bend due to pressure.

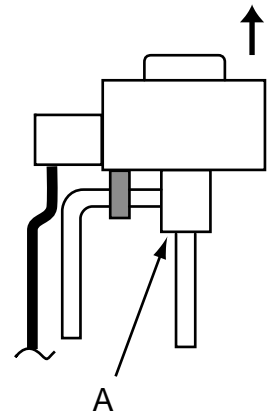

<How to attach the coil>

Hold the lower part of the main body (shown as A) firmly so that the main body does not move and attach the coil by inserting it downward into the main body. Then securely attach the coil stopper to pipe B. (At this time, be careful that stress is not added to lead wire and main body is not wound by lead wire.) If the stopper is not firmly attached to pipe B, coil may be detached from the main body and that can cause defective operation of linear expansion valve.

To prevent piping stress, be sure to attach the coil holding the main body of linear expansion valve firmly. Otherwise pipe may break.

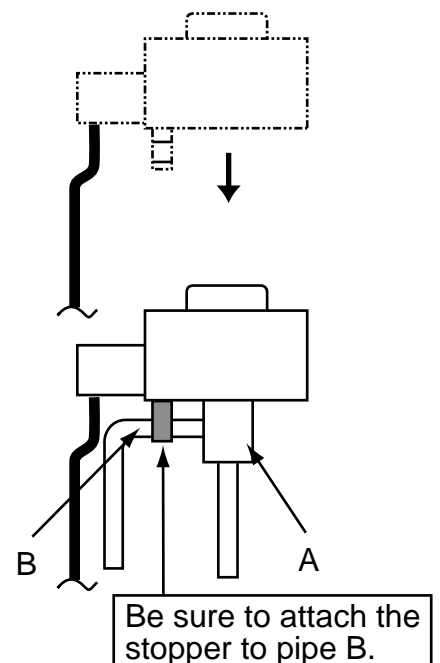

Troubleshooting

Problem	Check point	Corrective measure
Locked expansion valve	If the linear expansion valve becomes locked and the motor is still operating, the motor will emit a clicking noise and will not function. This clicking noise indicates an abnormality.	Replace the linear expansion valve.
Short circuit or broken circuit in expansion valve motor coil	Use an all-purpose electrical meter to measure the resistance between the different coils (red-white, red-orange, brown-yellow, brown-blue). Normal resistance is within a range of $46\Omega \pm 4\%$.	Replace the linear expansion valve.
Valve does not close completely.	In order to check the linear expansion valve, operate 1 indoor unit in the fan mode and another in the cooling mode. Then, use the outdoor multi controller board to operate the monitor and check the pipe temperature of the indoor unit. The linear expansion valve should be fully closed when the fan is operating. The temperature measured by the temperature sensor will drop if there is any leakage. If the measured temperature is significantly lower than that on the remote controller, this indicates that the valve is not closed. It is not necessary to replace the linear expansion valve if the leak of refrigerant is small and does not cause a malfunction.	Replace the linear expansion valve if there is a major leak of refrigerant.
Incorrect connection or connection failure	① Check improperly connected connector terminals and the wire colors. ② Remove the connector on the controller board side and check electrical conductance.	Continuity check of wrong part

8-7. TEST POINT DIAGRAM

Outdoor controller circuit board

MXZ-8B48NA

<CAUTION> TEST POINT① is high voltage.

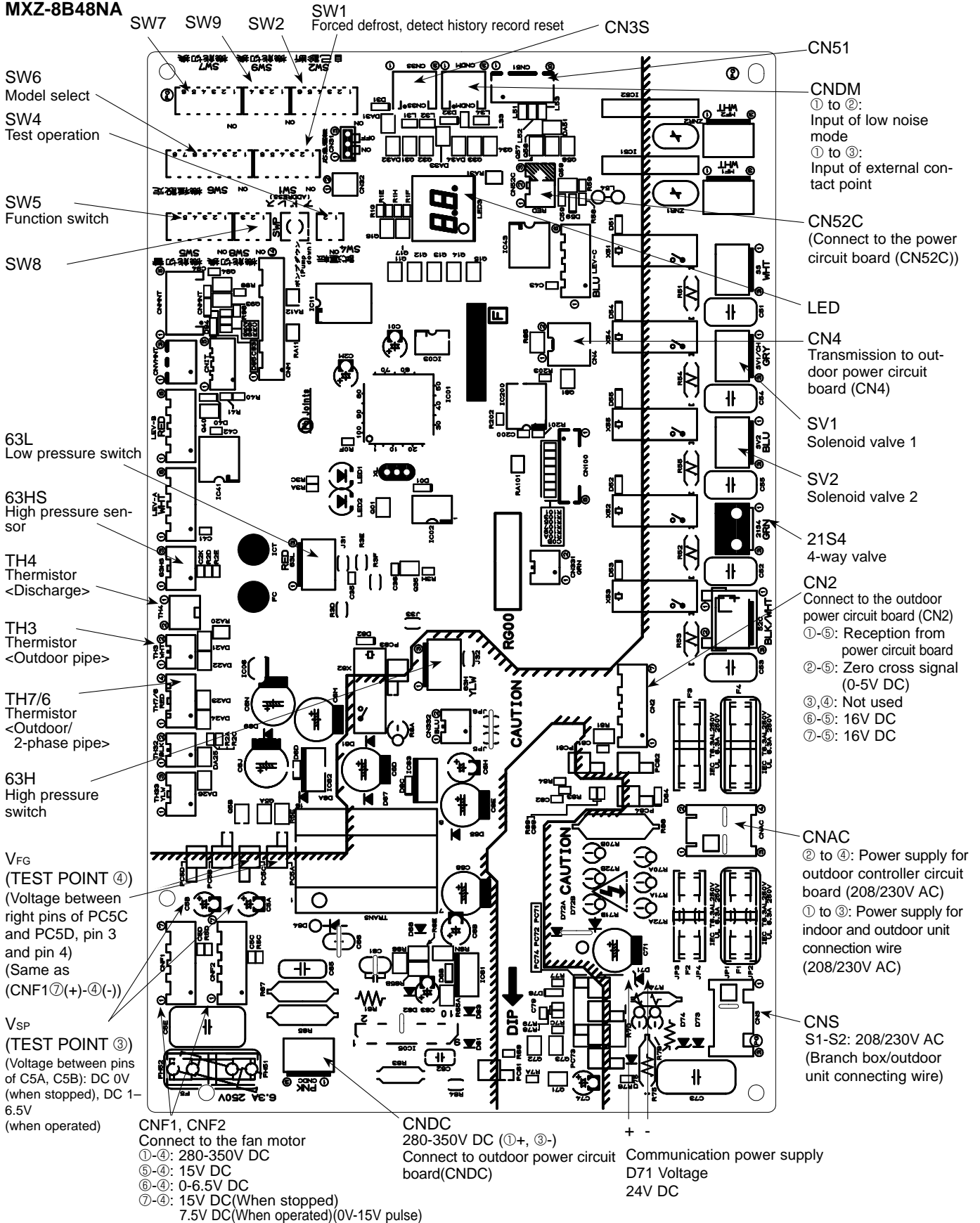

Outdoor power circuit board MXZ-8B48NA

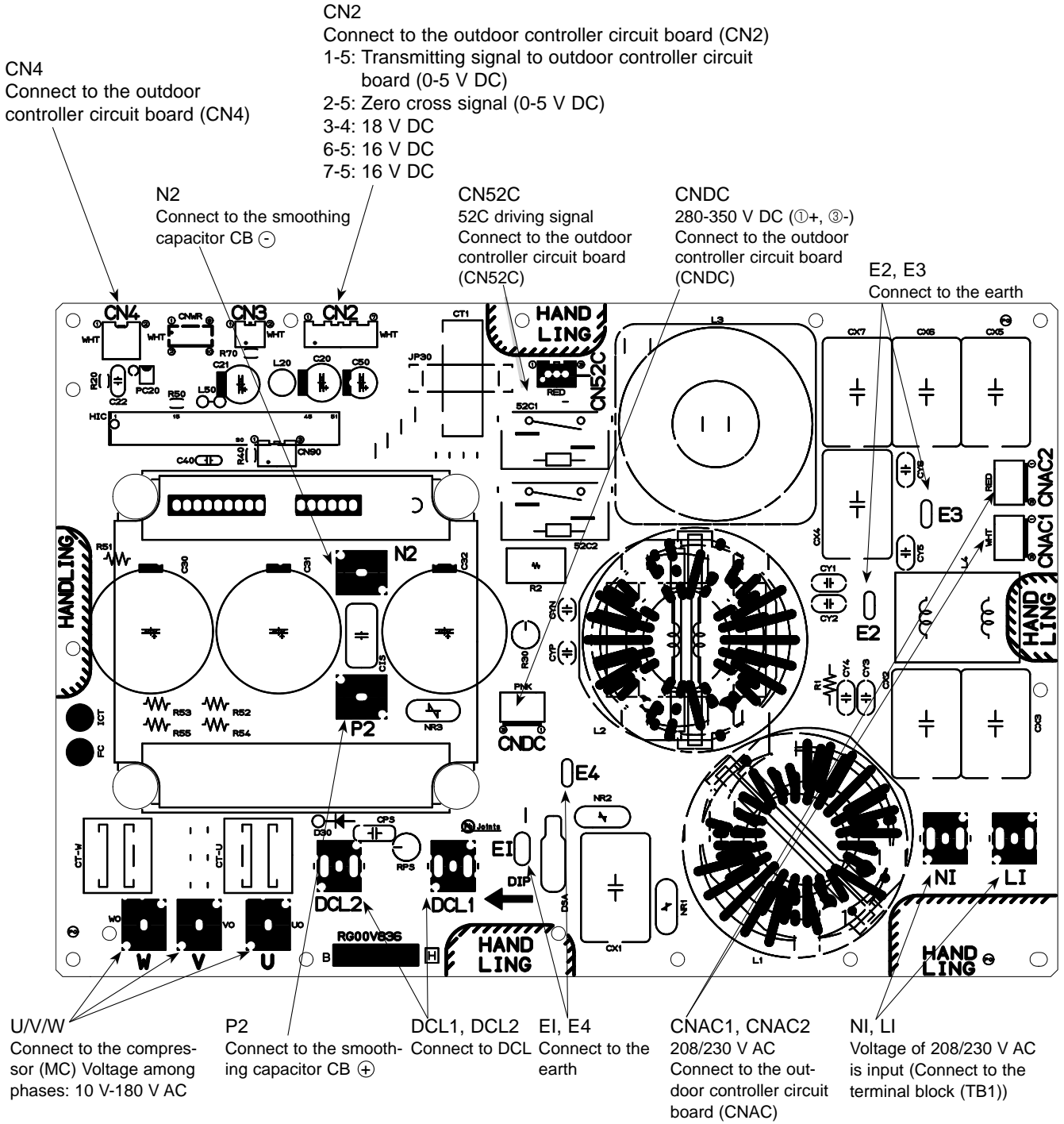

Branch box controller board
PAC-AKA51BC
PAC-AKA31BC

TH-A to E Connect to
 Thermistor-A to E
 TH-A to C for PAC-AKA31BC

LED1
 Transmission start-up state display
 Start-up : LED1 blinks
 (0.5sec. : ON, 0.5sec. : OFF)
 Start-up completion: LED1 lights

LEV-A to E
 Connect to LEV-A to E
 LEV-A to C for PAC-AKA31BC

LED3-5
 Not used

LED2
 Transmission
 (Branch box/outdoor)
 Reception state display
 on branch box side

Branch box No.1
 LED2 blinks once.
 (0.1sec. : ON,
 0.9sec. : OFF)

Branch box No.2
 LED2 blinks twice.
 (0.1sec. : ON,
 0.1sec. : OFF
 0.1sec. : ON,
 0.7sec. : OFF)

*The blinking interval
 might change when
 there are changes in
 states of indoor units.

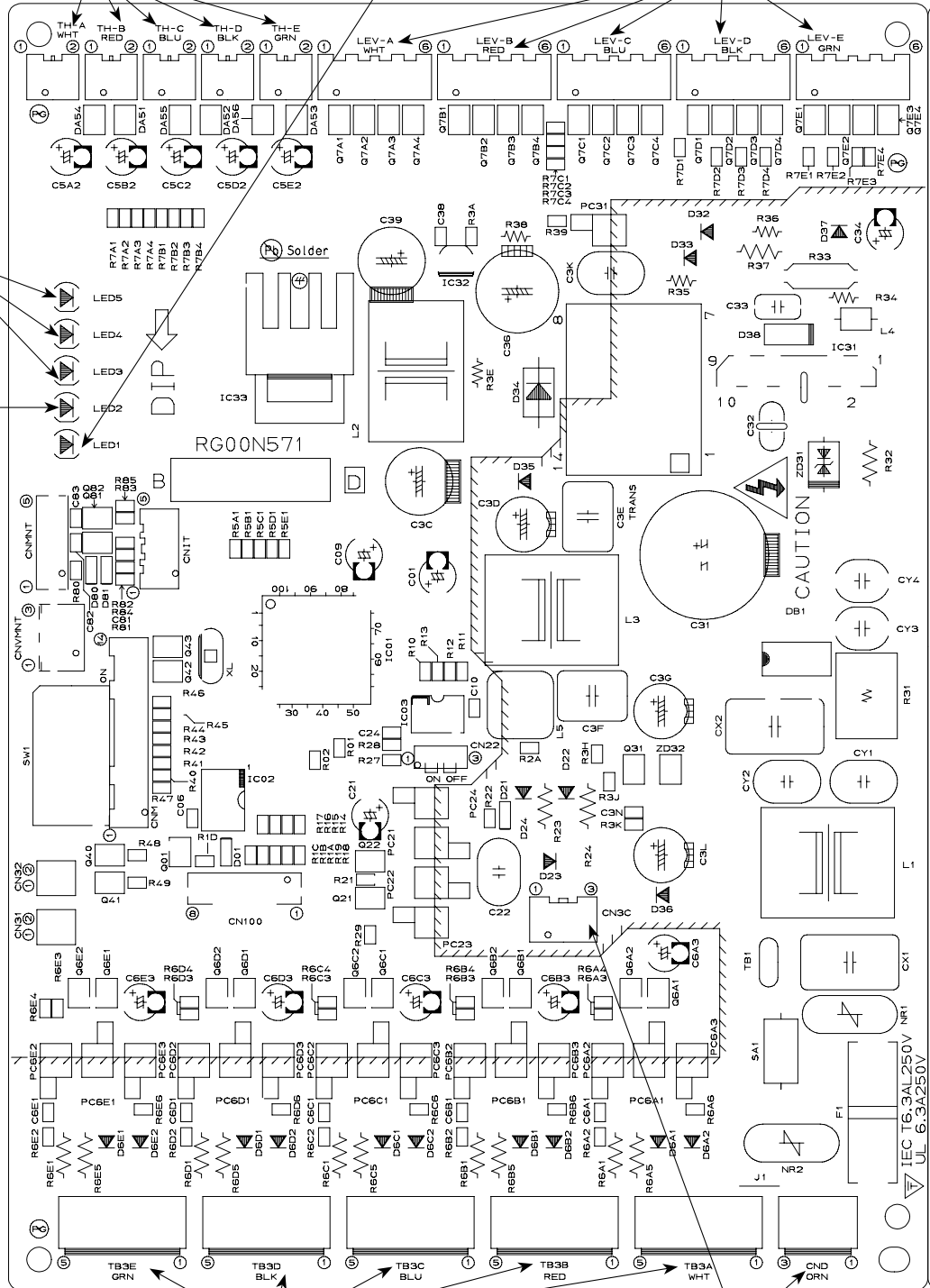

TB3A to TB3E
 Connect to TB3A to TB3E
 (Branch box / Indoor unit connecting wire)
 TB3A to TB3C for PAC-AKA31BC

CN3C, CND
 Connect to TB2B
 (Branch box / Outdoor unit
 connecting wire)

8-8. FUNCTION OF SWITCHES, CONNECTORS AND JUMPERS

(1) Function of switches

MXZ-8B48NA

The black square (■) indicates a switch position.

Type of Switch	Switch	No.	Function	Action by the switch operation		Effective timing	
				ON	OFF		
Dip switch	SW1	1	Forced defrost	Start	Normal	When compressor is working in heating operation. ※	
		2	Abnormal history clear	Clear	Normal	off or operating	
		3	No function	—	—	—	
		4	Self-diagnosis (Indoor unit selection)	ON	ON	ON	Indicating a particular self-diagnosis
		Indoor No.1		Indoor No.2	Indoor No.3		
	Indoor No.4	Indoor No.5		Indoor No.6			
Indoor No.7	Indoor No.8						
5	6	<Example>	<p>BC#1 : branch box controller unit Number 1 1 blinking LED2 (branch box controller board)</p> <p>BC#2 : branch box controller unit Number 2 2 blinking LED2 (branch box controller board)</p>				
Test run		Operating	OFF	Under suspension			
SW4	2	Test run mode setting	Heating		Cooling		

Forced defrost should be done as follows.

- ① Change the DIP SW1-1 on the outdoor controller board from OFF to ON.
- ② Forced defrost will start by the above operation ① if these conditions written below are satisfied.
 - Heat mode setting
 - 10 minutes have passed since compressor started operating or previous forced defrost finished.
 - Pipe temperature is less than or equal to 8°C [46 °F].
- ③ Forced defrost will finish if certain conditions are satisfied.

※ Forced defrost can be done if above conditions are satisfied when DIP SW1-1 is changed from OFF to ON.

After DIP SW1-1 is changed from OFF to ON, there is no problem if DIP SW1-1 is left ON or changed to OFF again. This depends on the service conditions.

MXZ-8B48NA

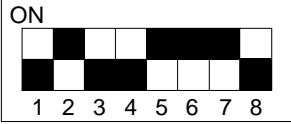
Type of Switch	Switch	No.	Function	Action by the switch operation		Effective timing	
				ON	OFF		
Dip switch	SW5	1	No function	—	—	—	
		2	Switching the target sub-cool (Heating mode)	Target sub-cool down	Normal	Always	
		3, 4	No function	—	—	—	
		5, 6	No function	—	—	—	
	SW7	1	Demand switching function	Capability cut 50%	Normal	Always	
		2	No function	—	—	—	
		3	Max. Frequency down	Active	Normal	Always	
		4	No function	—	—	—	
		5	No function	—	—	—	
		6	No function	—	—	—	
	SW8	1	No function	—	—	—	
		2	No function	—	—	—	
		3	No function	—	—	—	
	SW6	1	Model selection	<div style="text-align: center;"> <p>SW6</p>  </div>			
		2					
		3					
		4					
		5					
		6					
		7					
		8					
	SW9	1	LEV opening setting function for stopping unit during heating operation	Changed	Normal	Always	
		2	Switching function of defrosting prohibited time	60 minutes	30 minutes (Normal)	Always	
		3	Switching the Input Current Limit Level	3 A down	Normal	Before turning the power on	
		4	During the FAN or COOL mode, and thermo - OFF in heating operation, set the opening of liner expansion valve on branch box	Active	Inactive	While unit stopping	

PAC-AKA51BC, PAC-AKA31BC

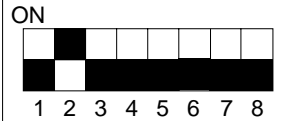
Type of Switch	Switch	No.	Function	Setting
Dip switch	SW1	1 - 8	Model selection	<div style="text-align: center;"> <p>ON</p>  </div>

(2) Function of connector MXZ-8B48NA

Types	Connector	Function	Action by Pin short operation		Effective timing
			Pin 1-2 Short	Pin 2-3 Short	
Connector	CN31	LEV opening function (at start-up)	Open a little bit	Normal	When power supply ON

<Outdoor unit operation monitor function>

Digital indicator LED3 displays 2 digit number or code to inform operation condition and the meaning of error code by controlling DIP SW2 on outdoor controller.

Operation indicator SW2 : Indicator change of self diagnosis

SW2 setting	Display detail	Explanation for display	Unit

<Digital indicator LED3 working details>

(Be sure that 1 to 6 in the SW2 are set to OFF.)

(1) Display when the power supply is ON.
When the power supply is ON, blinking displays by turns.
Wait for 4 minutes at the longest.

(2) When the display lights (Normal operation)
① Operation mode display

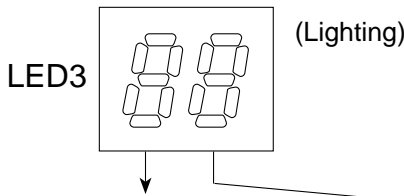
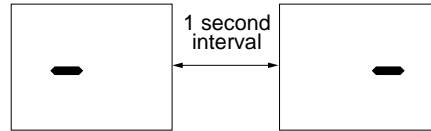

The tens digit : Operation mode

Display	Operation Model
O	OFF / FAN
C	COOLING / DRY
H	HEATING
d	DEFROSTING

The ones digit : Relay output

Display	Warming-up Compressor	Compressor	4-way valve	Solenoid valve (SV1, 2)
0	—	—	—	—
1	—	—	—	ON
2	—	—	ON	—
3	—	—	ON	ON
4	—	ON	—	—
5	—	ON	—	ON
6	—	ON	ON	—
7	—	ON	ON	ON
8	ON	—	—	—
A	ON	—	ON	—



② Display during error postponement
Postponement code is displayed when compressor stops due to the work of protection device.
Postponement code is displayed while error is being postponed.

(3) When the display blinks
Inspection code is displayed when compressor stops due to the work of protection devices.

Display	Inspection unit
0	Outdoor unit, Branch box unit
1	Indoor unit

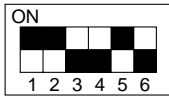
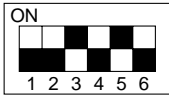

Display	Contents to be inspected (During operation)
U2	Discharge temperature fault
U7	Low-discharge superheating fault, Erroneous connection of refrigerant pipes or the connecting wires
U1	High pressure fault (63H operates)
UL	Low pressure fault (63L operates)
U6	Abnormality of power modules
UF	Compressor overcurrent shutoff (Start up locked)
UH	Current sensor fault (P. B.)
UP	Compressor overcurrent shutoff fault
U3	Discharge pipe/compressor thermistor (TH4) open or short-circuit
U4	Outdoor unit thermistors (TH3, TH6, TH7, and H8), 63HS, and branch box thermistors open or short-circuit
U5	HEATSINK temperature fault
U8	Abnormality in outdoor fan motor
U9	Voltage fault, current sensor fault (P.B.)
PA	Forced compressor stop (Overlap malfunction of drain pump in indoor unit and linear expansion valve in branch box.)

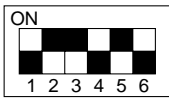
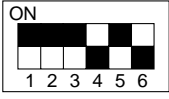
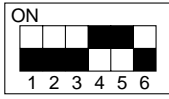
Display	Contents to be inspected (When power is turned on)
F3	63L connector(red) is open.
F5	63H connector(yellow) is open.
F9	2 connectors (63H/63L) are open.
E8	Branch box/outdoor communication error (Signal receiving error) (Outdoor unit) Indoor/branch box communication error (Signal receiving error) (Branch box)
E9	Branch box/outdoor communication error (Transmitting error) (Outdoor unit) Indoor/branch box communication error (Transmitting error) (Branch box)
EA	• Miswiring of indoor - branch box/branch box - outdoor unit connecting wire • Too many indoor units/branch box are in the system.
Eb	Miswiring of indoor - branch box/branch box - outdoor unit connecting wire(converse wiring or disconnection)
EC	Startup time over
E0-E7	Communication error except for outdoor unit

SW2 setting	Display detail	Explanation for display	Unit																																							
	Capacity setting display	Displayed as an outdoor capacity code. <table border="1" data-bbox="869 376 1161 450"> <thead> <tr> <th>Capacity</th> <th>Code</th> </tr> </thead> <tbody> <tr> <td>MXZ-8B48NA</td> <td>28</td> </tr> </tbody> </table>	Capacity	Code	MXZ-8B48NA	28	Code display																																			
Capacity	Code																																									
MXZ-8B48NA	28																																									
	Outdoor unit setting information	<ul style="list-style-type: none"> The tens digit (Total display for applied setting) <table border="1" data-bbox="826 526 1401 651"> <thead> <tr> <th>Setting details</th> <th>Display details</th> </tr> </thead> <tbody> <tr> <td>H·P / Cooling only</td> <td>0 : H·P 1 : Cooling only</td> </tr> <tr> <td>Single phase / 3 phase</td> <td>0 : Single phase 2 : 3 phase</td> </tr> </tbody> </table> The ones digit <table border="1" data-bbox="826 703 1401 786"> <thead> <tr> <th>Setting details</th> <th>Display details</th> </tr> </thead> <tbody> <tr> <td>Defrosting switch</td> <td>0 : Normal 1 : For high humidity</td> </tr> </tbody> </table> (Example) MXZ-8B48NA, "00" is displayed. 	Setting details	Display details	H·P / Cooling only	0 : H·P 1 : Cooling only	Single phase / 3 phase	0 : Single phase 2 : 3 phase	Setting details	Display details	Defrosting switch	0 : Normal 1 : For high humidity	Code display																													
Setting details	Display details																																									
H·P / Cooling only	0 : H·P 1 : Cooling only																																									
Single phase / 3 phase	0 : Single phase 2 : 3 phase																																									
Setting details	Display details																																									
Defrosting switch	0 : Normal 1 : For high humidity																																									
	Indoor pipe temperature / Liquid – 38~190 <table border="1" data-bbox="598 875 794 1106"> <thead> <tr> <th rowspan="2"></th> <th colspan="3">SW1</th> </tr> <tr> <th>4</th> <th>5</th> <th>6</th> </tr> </thead> <tbody> <tr><td>Indoor unit 1</td><td>0</td><td>0</td><td>0</td></tr> <tr><td>Indoor unit 2</td><td>1</td><td>0</td><td>0</td></tr> <tr><td>Indoor unit 3</td><td>0</td><td>1</td><td>0</td></tr> <tr><td>Indoor unit 4</td><td>1</td><td>1</td><td>0</td></tr> <tr><td>Indoor unit 5</td><td>0</td><td>0</td><td>1</td></tr> <tr><td>Indoor unit 6</td><td>1</td><td>0</td><td>1</td></tr> <tr><td>Indoor unit 7</td><td>0</td><td>1</td><td>1</td></tr> <tr><td>Indoor unit 8</td><td>1</td><td>1</td><td>1</td></tr> </tbody> </table>		SW1			4	5	6	Indoor unit 1	0	0	0	Indoor unit 2	1	0	0	Indoor unit 3	0	1	0	Indoor unit 4	1	1	0	Indoor unit 5	0	0	1	Indoor unit 6	1	0	1	Indoor unit 7	0	1	1	Indoor unit 8	1	1	1	– 38~190 (When the temperature is 0°F or less, "–" and temperature are displayed by turns.)	°F
	SW1																																									
	4	5	6																																							
Indoor unit 1	0	0	0																																							
Indoor unit 2	1	0	0																																							
Indoor unit 3	0	1	0																																							
Indoor unit 4	1	1	0																																							
Indoor unit 5	0	0	1																																							
Indoor unit 6	1	0	1																																							
Indoor unit 7	0	1	1																																							
Indoor unit 8	1	1	1																																							
	Indoor pipe temperature / Cond. / Eva. Indoor – 38~190 <table border="1" data-bbox="598 1144 794 1375"> <thead> <tr> <th rowspan="2"></th> <th colspan="3">SW1</th> </tr> <tr> <th>4</th> <th>5</th> <th>6</th> </tr> </thead> <tbody> <tr><td>Indoor unit 1</td><td>0</td><td>0</td><td>0</td></tr> <tr><td>Indoor unit 2</td><td>1</td><td>0</td><td>0</td></tr> <tr><td>Indoor unit 3</td><td>0</td><td>1</td><td>0</td></tr> <tr><td>Indoor unit 4</td><td>1</td><td>1</td><td>0</td></tr> <tr><td>Indoor unit 5</td><td>0</td><td>0</td><td>1</td></tr> <tr><td>Indoor unit 6</td><td>1</td><td>0</td><td>1</td></tr> <tr><td>Indoor unit 7</td><td>0</td><td>1</td><td>1</td></tr> <tr><td>Indoor unit 8</td><td>1</td><td>1</td><td>1</td></tr> </tbody> </table>		SW1			4	5	6	Indoor unit 1	0	0	0	Indoor unit 2	1	0	0	Indoor unit 3	0	1	0	Indoor unit 4	1	1	0	Indoor unit 5	0	0	1	Indoor unit 6	1	0	1	Indoor unit 7	0	1	1	Indoor unit 8	1	1	1	– 38~190 (When the temperature is 0°F or less, "–" and temperature are displayed by turns.)	°F
	SW1																																									
	4	5	6																																							
Indoor unit 1	0	0	0																																							
Indoor unit 2	1	0	0																																							
Indoor unit 3	0	1	0																																							
Indoor unit 4	1	1	0																																							
Indoor unit 5	0	0	1																																							
Indoor unit 6	1	0	1																																							
Indoor unit 7	0	1	1																																							
Indoor unit 8	1	1	1																																							
	Branch box pipe temperature / gas – 38~190 <table border="1" data-bbox="598 1413 794 1644"> <thead> <tr> <th rowspan="2"></th> <th colspan="3">SW1</th> </tr> <tr> <th>4</th> <th>5</th> <th>6</th> </tr> </thead> <tbody> <tr><td>Indoor unit 1</td><td>0</td><td>0</td><td>0</td></tr> <tr><td>Indoor unit 2</td><td>1</td><td>0</td><td>0</td></tr> <tr><td>Indoor unit 3</td><td>0</td><td>1</td><td>0</td></tr> <tr><td>Indoor unit 4</td><td>1</td><td>1</td><td>0</td></tr> <tr><td>Indoor unit 5</td><td>0</td><td>0</td><td>1</td></tr> <tr><td>Indoor unit 6</td><td>1</td><td>0</td><td>1</td></tr> <tr><td>Indoor unit 7</td><td>0</td><td>1</td><td>1</td></tr> <tr><td>Indoor unit 8</td><td>1</td><td>1</td><td>1</td></tr> </tbody> </table>		SW1			4	5	6	Indoor unit 1	0	0	0	Indoor unit 2	1	0	0	Indoor unit 3	0	1	0	Indoor unit 4	1	1	0	Indoor unit 5	0	0	1	Indoor unit 6	1	0	1	Indoor unit 7	0	1	1	Indoor unit 8	1	1	1	– 38~190 (When the temperature is 0°F or less, "–" and temperature are displayed by turns.)	°F
	SW1																																									
	4	5	6																																							
Indoor unit 1	0	0	0																																							
Indoor unit 2	1	0	0																																							
Indoor unit 3	0	1	0																																							
Indoor unit 4	1	1	0																																							
Indoor unit 5	0	0	1																																							
Indoor unit 6	1	0	1																																							
Indoor unit 7	0	1	1																																							
Indoor unit 8	1	1	1																																							
	Targeted evaporating temperature : ETm (Cooling) – 38~190 Targeted high pressure : Pdm (Heating) 0~711	ETm : – 38~190, Pdm : 0~711 (When the temperature is 0°F or less, "–" and temperature are displayed by turns.)	°F PSIG																																							
	Indoor room temperature 46~102 <table border="1" data-bbox="598 1825 794 2056"> <thead> <tr> <th rowspan="2"></th> <th colspan="3">SW1</th> </tr> <tr> <th>4</th> <th>5</th> <th>6</th> </tr> </thead> <tbody> <tr><td>Indoor unit 1</td><td>0</td><td>0</td><td>0</td></tr> <tr><td>Indoor unit 2</td><td>1</td><td>0</td><td>0</td></tr> <tr><td>Indoor unit 3</td><td>0</td><td>1</td><td>0</td></tr> <tr><td>Indoor unit 4</td><td>1</td><td>1</td><td>0</td></tr> <tr><td>Indoor unit 5</td><td>0</td><td>0</td><td>1</td></tr> <tr><td>Indoor unit 6</td><td>1</td><td>0</td><td>1</td></tr> <tr><td>Indoor unit 7</td><td>0</td><td>1</td><td>1</td></tr> <tr><td>Indoor unit 8</td><td>1</td><td>1</td><td>1</td></tr> </tbody> </table>		SW1			4	5	6	Indoor unit 1	0	0	0	Indoor unit 2	1	0	0	Indoor unit 3	0	1	0	Indoor unit 4	1	1	0	Indoor unit 5	0	0	1	Indoor unit 6	1	0	1	Indoor unit 7	0	1	1	Indoor unit 8	1	1	1	46~102 (When the temperature is 100°F or more, the hundreds digit, tens digit and ones digit are displayed by turns.)	°F
	SW1																																									
	4	5	6																																							
Indoor unit 1	0	0	0																																							
Indoor unit 2	1	0	0																																							
Indoor unit 3	0	1	0																																							
Indoor unit 4	1	1	0																																							
Indoor unit 5	0	0	1																																							
Indoor unit 6	1	0	1																																							
Indoor unit 7	0	1	1																																							
Indoor unit 8	1	1	1																																							



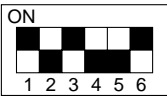
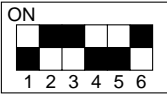
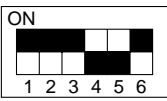
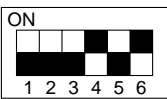

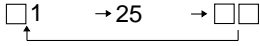
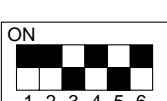
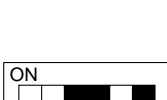
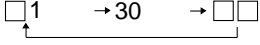
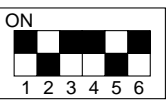
SW2 setting	Display detail	Explanation for display	Unit																																								
	Indoor setting temperature 62~86 <table border="1" style="margin-left: 20px;"> <thead> <tr> <th></th> <th colspan="3">SW1</th> </tr> <tr> <th></th> <th>4</th> <th>5</th> <th>6</th> </tr> </thead> <tbody> <tr> <td>Indoor unit 1</td> <td>0</td> <td>0</td> <td>0</td> </tr> <tr> <td>Indoor unit 2</td> <td>1</td> <td>0</td> <td>0</td> </tr> <tr> <td>Indoor unit 3</td> <td>0</td> <td>1</td> <td>0</td> </tr> <tr> <td>Indoor unit 4</td> <td>1</td> <td>1</td> <td>0</td> </tr> <tr> <td>Indoor unit 5</td> <td>0</td> <td>0</td> <td>1</td> </tr> <tr> <td>Indoor unit 6</td> <td>1</td> <td>0</td> <td>1</td> </tr> <tr> <td>Indoor unit 7</td> <td>0</td> <td>1</td> <td>1</td> </tr> <tr> <td>Indoor unit 8</td> <td>1</td> <td>1</td> <td>1</td> </tr> </tbody> </table>		SW1				4	5	6	Indoor unit 1	0	0	0	Indoor unit 2	1	0	0	Indoor unit 3	0	1	0	Indoor unit 4	1	1	0	Indoor unit 5	0	0	1	Indoor unit 6	1	0	1	Indoor unit 7	0	1	1	Indoor unit 8	1	1	1	62~86	°F
	SW1																																										
	4	5	6																																								
Indoor unit 1	0	0	0																																								
Indoor unit 2	1	0	0																																								
Indoor unit 3	0	1	0																																								
Indoor unit 4	1	1	0																																								
Indoor unit 5	0	0	1																																								
Indoor unit 6	1	0	1																																								
Indoor unit 7	0	1	1																																								
Indoor unit 8	1	1	1																																								
	Outdoor pipe temperature / 2-phase (TH6) - 38~190	- 38~190 (When the temperature is 0°F or less, “-” and temperature are displayed by turns.)	°F																																								
	Outdoor temperature (TH7) - 38~190	- 38~190 (When the temperature is 0°F or less, “-” and temperature are displayed by turns.)	°F																																								
	Outdoor heatsink temperature (TH8) - 40~327	- 40~327 (When the temperature is 0°F or less, “-” and temperature are displayed by turns.) (When the thermistor detects 100°F or more, hundreds digit, tens digit and ones digit are displayed by turns.)	°F																																								
	Discharge superheat. SHd 0~255	0~255 (When the temperature is 100°C or more, hundreds digit, tens digit and ones digit are displayed by turns.)	°C																																								
	Sub-cool. SC (cooling mode) 0~130	0~130 (When the temperature is 100°C or more, hundreds digit, tens digit and ones digit are displayed by turns.)	°C																																								
	Input current of outdoor unit	0~500 (When it is 100 or more, hundreds digit, tens digit and ones digit are displayed by turns.)	0.1 A																																								
	High pressure 63HS	0~815 (When it is 100 or more, hundreds digit, tens digit and ones digit are displayed by turns.)	PSIG																																								
	Targeted operation frequency 0~255	0~255 (When it is 100Hz or more, hundreds digit, tens digit and ones digit are displayed by turns.)	Hz																																								
	DC bus voltage 180~370	180~370 (When it is 100V or more, hundreds digit, tens digit and ones digit are displayed by turns.)	V																																								

SW2 setting	Display detail	Explanation for display	Unit																																								
	Target Sub-cool (Cooling mode) : SCm	0~255	℃																																								
	Error postponement code history (2) of outdoor unit	Postponement code display Blinking: During postponement Lighting: Cancellation of postponement "00" is displayed in case of no postponement.	Code display																																								
	Error postponement code history (3) of outdoor unit	Postponement code display Blinking: During postponement Lighting: Cancellation of postponement "00" is displayed in case of no postponement.	Code display																																								
	Error code history (3) (Oldest) Alternate display of abnormal unit number and code	When no error history, "0" and "-" are displayed by turns.	Code display																																								
	Error thermistor display [When there is no error thermistor, "—" is displayed.]	3 : Outdoor pipe temperature /Liquid (TH3) 7 : Outdoor outside temperature (TH7) 8 : Outdoor heatsink (TH8) 23 : Branch box pipe temperature / Gas (TH-A-E) 63 : High pressure sensor (63HS)	Code display																																								
	Operation frequency on error occurring 0~255	0~255 (When it is 100Hz or more, hundreds digit, tens digit and ones digit are displayed by turns.) (Example) When 125Hz; 0.5 secs. 0.5secs. 2 secs. 	Hz																																								
	Fan step on error occurring 0~10	0~10	Step																																								
	LEV opening pulse on error occurring 0~500	0~500 (When it is 100 pulse or more, hundreds digit, tens digit and ones digit are displayed by turns.) (Example) When 130 pulse; 0.5 secs. 0.5secs. 2 secs. 	Pulse																																								
	Indoor room temperature on error occurring 8~39	<table border="1" data-bbox="612 1518 810 1742"> <thead> <tr> <th rowspan="2"></th> <th colspan="3">SW1</th> </tr> <tr> <th>4</th> <th>5</th> <th>6</th> </tr> </thead> <tbody> <tr><td>Indoor unit 1</td><td>0</td><td>0</td><td>0</td></tr> <tr><td>Indoor unit 2</td><td>1</td><td>0</td><td>0</td></tr> <tr><td>Indoor unit 3</td><td>0</td><td>1</td><td>0</td></tr> <tr><td>Indoor unit 4</td><td>1</td><td>1</td><td>0</td></tr> <tr><td>Indoor unit 5</td><td>0</td><td>0</td><td>1</td></tr> <tr><td>Indoor unit 6</td><td>1</td><td>0</td><td>1</td></tr> <tr><td>Indoor unit 7</td><td>0</td><td>1</td><td>1</td></tr> <tr><td>Indoor unit 8</td><td>1</td><td>1</td><td>1</td></tr> </tbody> </table>		SW1			4	5	6	Indoor unit 1	0	0	0	Indoor unit 2	1	0	0	Indoor unit 3	0	1	0	Indoor unit 4	1	1	0	Indoor unit 5	0	0	1	Indoor unit 6	1	0	1	Indoor unit 7	0	1	1	Indoor unit 8	1	1	1	8~39	℃
	SW1																																										
	4	5	6																																								
Indoor unit 1	0	0	0																																								
Indoor unit 2	1	0	0																																								
Indoor unit 3	0	1	0																																								
Indoor unit 4	1	1	0																																								
Indoor unit 5	0	0	1																																								
Indoor unit 6	1	0	1																																								
Indoor unit 7	0	1	1																																								
Indoor unit 8	1	1	1																																								

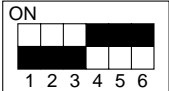
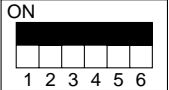

SW2 setting	Display detail	Explanation for display	Unit																																								
	Indoor pipe temperature / Liquid on error occurring – 39~88 <table border="1"> <thead> <tr> <th></th> <th colspan="3">SW1</th> </tr> <tr> <th></th> <th>4</th> <th>5</th> <th>6</th> </tr> </thead> <tbody> <tr> <td>Indoor unit 1</td> <td>0</td> <td>0</td> <td>0</td> </tr> <tr> <td>Indoor unit 2</td> <td>1</td> <td>0</td> <td>0</td> </tr> <tr> <td>Indoor unit 3</td> <td>0</td> <td>1</td> <td>0</td> </tr> <tr> <td>Indoor unit 4</td> <td>1</td> <td>1</td> <td>0</td> </tr> <tr> <td>Indoor unit 5</td> <td>0</td> <td>0</td> <td>1</td> </tr> <tr> <td>Indoor unit 6</td> <td>1</td> <td>0</td> <td>1</td> </tr> <tr> <td>Indoor unit 7</td> <td>0</td> <td>1</td> <td>1</td> </tr> <tr> <td>Indoor unit 8</td> <td>1</td> <td>1</td> <td>1</td> </tr> </tbody> </table>		SW1				4	5	6	Indoor unit 1	0	0	0	Indoor unit 2	1	0	0	Indoor unit 3	0	1	0	Indoor unit 4	1	1	0	Indoor unit 5	0	0	1	Indoor unit 6	1	0	1	Indoor unit 7	0	1	1	Indoor unit 8	1	1	1	– 39~88 (When the temperature is 0°C or less, “-” and temperature are displayed by turns.) (Example) When –15°C; 0.5 secs. 0.5secs. 2 secs. -□ → 15 → □□	°C
	SW1																																										
	4	5	6																																								
Indoor unit 1	0	0	0																																								
Indoor unit 2	1	0	0																																								
Indoor unit 3	0	1	0																																								
Indoor unit 4	1	1	0																																								
Indoor unit 5	0	0	1																																								
Indoor unit 6	1	0	1																																								
Indoor unit 7	0	1	1																																								
Indoor unit 8	1	1	1																																								
	Indoor pipe temperature / Cond./ Eva. on error occurring – 39~88 <table border="1"> <thead> <tr> <th></th> <th colspan="3">SW1</th> </tr> <tr> <th></th> <th>4</th> <th>5</th> <th>6</th> </tr> </thead> <tbody> <tr> <td>Indoor unit 1</td> <td>0</td> <td>0</td> <td>0</td> </tr> <tr> <td>Indoor unit 2</td> <td>1</td> <td>0</td> <td>0</td> </tr> <tr> <td>Indoor unit 3</td> <td>0</td> <td>1</td> <td>0</td> </tr> <tr> <td>Indoor unit 4</td> <td>1</td> <td>1</td> <td>0</td> </tr> <tr> <td>Indoor unit 5</td> <td>0</td> <td>0</td> <td>1</td> </tr> <tr> <td>Indoor unit 6</td> <td>1</td> <td>0</td> <td>1</td> </tr> <tr> <td>Indoor unit 7</td> <td>0</td> <td>1</td> <td>1</td> </tr> <tr> <td>Indoor unit 8</td> <td>1</td> <td>1</td> <td>1</td> </tr> </tbody> </table>		SW1				4	5	6	Indoor unit 1	0	0	0	Indoor unit 2	1	0	0	Indoor unit 3	0	1	0	Indoor unit 4	1	1	0	Indoor unit 5	0	0	1	Indoor unit 6	1	0	1	Indoor unit 7	0	1	1	Indoor unit 8	1	1	1	– 39~88 (When the temperature is 0°C or less, “-” and temperature are displayed by turns.) (Example) When –15°C; 0.5 secs. 0.5secs. 2 secs. -□ → 15 → □□	°C
	SW1																																										
	4	5	6																																								
Indoor unit 1	0	0	0																																								
Indoor unit 2	1	0	0																																								
Indoor unit 3	0	1	0																																								
Indoor unit 4	1	1	0																																								
Indoor unit 5	0	0	1																																								
Indoor unit 6	1	0	1																																								
Indoor unit 7	0	1	1																																								
Indoor unit 8	1	1	1																																								
	Outdoor pipe temperature / 2-phase (TH6) on error occurring – 39~88	– 39~88 (When the temperature is 0°C or less, “-” and temperature are displayed by turns.) (Example) When –15°C; 0.5 secs. 0.5secs. 2 secs. -□ → 15 → □□	°C																																								
	Outdoor outside temperature (TH7) on error occurring – 39~88	– 39~88 (When the temperature is 0°C or less, “-” and temperature are displayed by turns.) (Example) When –15°C; 0.5 secs. 0.5secs. 2 secs. -□ → 15 → □□	°C																																								
	Outdoor heatsink temperature (TH8) on error occurring – 40~200	– 40~200 (When the temperature is 0°C or less, “-” and temperature are displayed by turns.) (When the temperature is 100°C or more, hundreds digit, tens digit and ones digit are displayed by turns.)	°C																																								
	Discharge superheat on error occurring SHd 0~255	0~255 (When the temperature is 100°C or more, hundreds digit, tens digit and ones digit are displayed by turns.) (Example) When 150°C; 0.5 secs. 0.5secs. 2 secs. □1 → 50 → □□	°C																																								
	Sub-cool on error occurring. SC 0~130	0~130 (When the temperature is 100°C or more, hundreds digit, tens digit and ones digit are displayed by turns.) (Example) When 115°C; 0.5 secs. 0.5secs. 2 secs. □1 → 15 → □□	°C																																								

SW2 setting	Display detail	Explanation for display	Unit																																																					
	Thermo ON time until error stops 0~999	0~999 (When it is 100 minutes or more, hundreds digit, tens digit and ones digit are displayed by turns.) (Example) When 415 minutes; 0.5 secs. 0.5secs. 2 secs. □4 → 15 → □□	Minute																																																					
	Target rotation of outdoor fan motor	0~999	rpm																																																					
	Sub-cool (Heating mode)	0~130	°C																																																					
	Code of the difference between room temperature and set temperature ("ΔTj": 0 - 99 °C) ■ Tens digit of code: current ΔTj ■ Units digit of code: ΔTj a minute ago	Code of the difference between room temperature and set temperature ("ΔTj") <table border="1" data-bbox="837 1088 1398 1447"> <thead> <tr> <th rowspan="2">ΔTj</th> <th>Cooling</th> <th>Heating</th> </tr> <tr> <th>ΔTj = room temp. - Set temp.</th> <th>ΔTj = Set temp. - room temp.</th> </tr> </thead> <tbody> <tr> <td>0</td> <td>ΔTj ≤ -0.5</td> <td>ΔTj ≤ -0.5</td> </tr> <tr> <td>1</td> <td>-1.0 < ΔTj ≤ -0.5</td> <td>-0.5 < ΔTj ≤ 0.0</td> </tr> <tr> <td>2</td> <td>-0.5 < ΔTj ≤ -0.5</td> <td>0.0 < ΔTj ≤ 0.5</td> </tr> <tr> <td>3</td> <td>0.0 < ΔTj ≤ 0.0</td> <td>0.5 < ΔTj ≤ 1.0</td> </tr> <tr> <td>4</td> <td>0.5 < ΔTj ≤ 0.5</td> <td>1.0 < ΔTj ≤ 1.5</td> </tr> <tr> <td>5</td> <td>1.0 < ΔTj ≤ 1.0</td> <td>1.5 < ΔTj ≤ 2.0</td> </tr> <tr> <td>6</td> <td>1.5 < ΔTj ≤ 0.5</td> <td>2.0 < ΔTj ≤ 2.5</td> </tr> <tr> <td>7</td> <td>2.0 < ΔTj ≤ 2.0</td> <td>2.5 < ΔTj ≤ 3.0</td> </tr> <tr> <td>8</td> <td>2.5 < ΔTj ≤ 2.5</td> <td>3.0 < ΔTj ≤ 3.5</td> </tr> <tr> <td>9</td> <td>3.0 < ΔTj ≤ 3.0</td> <td>3.5 < ΔTj</td> </tr> </tbody> </table> <table border="1" data-bbox="837 1485 1155 1753"> <thead> <tr> <th>SW setting (1-4, 5, 6)</th> <th>Target unit</th> </tr> </thead> <tbody> <tr> <td>000</td> <td>Indoor unit 1</td> </tr> <tr> <td>100</td> <td>Indoor unit 2</td> </tr> <tr> <td>010</td> <td>Indoor unit 3</td> </tr> <tr> <td>110</td> <td>Indoor unit 4</td> </tr> <tr> <td>001</td> <td>Indoor unit 5</td> </tr> <tr> <td>101</td> <td>Indoor unit 6</td> </tr> <tr> <td>011</td> <td>Indoor unit 7</td> </tr> <tr> <td>111</td> <td>Indoor unit 8</td> </tr> </tbody> </table>	ΔTj	Cooling	Heating	ΔTj = room temp. - Set temp.	ΔTj = Set temp. - room temp.	0	ΔTj ≤ -0.5	ΔTj ≤ -0.5	1	-1.0 < ΔTj ≤ -0.5	-0.5 < ΔTj ≤ 0.0	2	-0.5 < ΔTj ≤ -0.5	0.0 < ΔTj ≤ 0.5	3	0.0 < ΔTj ≤ 0.0	0.5 < ΔTj ≤ 1.0	4	0.5 < ΔTj ≤ 0.5	1.0 < ΔTj ≤ 1.5	5	1.0 < ΔTj ≤ 1.0	1.5 < ΔTj ≤ 2.0	6	1.5 < ΔTj ≤ 0.5	2.0 < ΔTj ≤ 2.5	7	2.0 < ΔTj ≤ 2.0	2.5 < ΔTj ≤ 3.0	8	2.5 < ΔTj ≤ 2.5	3.0 < ΔTj ≤ 3.5	9	3.0 < ΔTj ≤ 3.0	3.5 < ΔTj	SW setting (1-4, 5, 6)	Target unit	000	Indoor unit 1	100	Indoor unit 2	010	Indoor unit 3	110	Indoor unit 4	001	Indoor unit 5	101	Indoor unit 6	011	Indoor unit 7	111	Indoor unit 8	Code display
ΔTj	Cooling	Heating																																																						
	ΔTj = room temp. - Set temp.	ΔTj = Set temp. - room temp.																																																						
0	ΔTj ≤ -0.5	ΔTj ≤ -0.5																																																						
1	-1.0 < ΔTj ≤ -0.5	-0.5 < ΔTj ≤ 0.0																																																						
2	-0.5 < ΔTj ≤ -0.5	0.0 < ΔTj ≤ 0.5																																																						
3	0.0 < ΔTj ≤ 0.0	0.5 < ΔTj ≤ 1.0																																																						
4	0.5 < ΔTj ≤ 0.5	1.0 < ΔTj ≤ 1.5																																																						
5	1.0 < ΔTj ≤ 1.0	1.5 < ΔTj ≤ 2.0																																																						
6	1.5 < ΔTj ≤ 0.5	2.0 < ΔTj ≤ 2.5																																																						
7	2.0 < ΔTj ≤ 2.0	2.5 < ΔTj ≤ 3.0																																																						
8	2.5 < ΔTj ≤ 2.5	3.0 < ΔTj ≤ 3.5																																																						
9	3.0 < ΔTj ≤ 3.0	3.5 < ΔTj																																																						
SW setting (1-4, 5, 6)	Target unit																																																							
000	Indoor unit 1																																																							
100	Indoor unit 2																																																							
010	Indoor unit 3																																																							
110	Indoor unit 4																																																							
001	Indoor unit 5																																																							
101	Indoor unit 6																																																							
011	Indoor unit 7																																																							
111	Indoor unit 8																																																							
	U9 Error status during the Error postponement period	<table border="1" data-bbox="826 1787 1401 1944"> <thead> <tr> <th>Description</th> <th>Detection point</th> <th>Display</th> </tr> </thead> <tbody> <tr> <td>Normal</td> <td>—</td> <td>00</td> </tr> <tr> <td>Oversvoltage error</td> <td>Power circuit board</td> <td>01</td> </tr> <tr> <td>Undersvoltage error</td> <td>Controller circuit board</td> <td>02</td> </tr> <tr> <td>L1 or L2 phase interruption error</td> <td>Power circuit board</td> <td>04</td> </tr> <tr> <td>Abnormal power synchronous signal</td> <td>Power circuit board</td> <td>08</td> </tr> </tbody> </table> * Display examples for multiple errors: Oversvoltage (01) + Undersvoltage (02) = 03 Undersvoltage (02) + Power-sync signal error (08) = 0A	Description	Detection point	Display	Normal	—	00	Oversvoltage error	Power circuit board	01	Undersvoltage error	Controller circuit board	02	L1 or L2 phase interruption error	Power circuit board	04	Abnormal power synchronous signal	Power circuit board	08	Code display																																			
Description	Detection point	Display																																																						
Normal	—	00																																																						
Oversvoltage error	Power circuit board	01																																																						
Undersvoltage error	Controller circuit board	02																																																						
L1 or L2 phase interruption error	Power circuit board	04																																																						
Abnormal power synchronous signal	Power circuit board	08																																																						

<Branch box unit operation monitor function>

[When option part 'A-Control Service Tool (PAC-SK52ST)' is connected to branch box controller board (CNM)]

Digital indicator LED1 displays 2 digit number or code to inform operation condition and the meaning of error code by controlling DIP SW2 on 'A-Control Service Tool'.

Operation indicator SW2 : Indicator change of self diagnosis



SW2 setting	Display detail	Explanation for display	Unit
	<p><Digital indicator LED1 working details> (Be sure that 1 to 6 in the SW2 are set to OFF.) (1) Display when the power supply is ON. When the power supply is ON, blinking displays by turns. Wait for 2 minutes at the longest. (2) When the display lights (Normal operation) ①The number of connected indoor units to this branch box (0 - 5)</p> <p>LED1 (Lighting)</p> <p>SW2 (Initial setting)</p>		
	Pipe temperature / Liquid (TH3) - 40~90 (°C) - 40~194 (°F)*	- 40~90 (°C), - 40~194 (°F) (When the coil thermistor detects 0°C or below, “-” and temperature are displayed by turns.) (Example) When -10°C; 0.5 secs. 0.5secs. 2 secs. -□ → 10 → □□	°C °F(*)
	Discharge temperature (TH4) 3~217 (°C) 37~327 (°F)*	3~217 (°C), 37~327 (°F)* (When the discharge thermistor detects 100°C or more, hundreds digit, tens digit and ones digit are displayed by turns.) (Example) When 105°C; 0.5 secs. 0.5secs. 2 secs. □1 → 05 → □□	°C °F(*)
	Output step of outdoor FAN 0~15	0~15	Step
	Unit number of this branch box 1~2	1 or 2 * Omit the figures after the decimal fractions.	Code display
	Compressor operating frequency 0~225	0~255 (When it is 100Hz or more, hundreds digit, tens digit and ones digit are displayed by turns.) (Example) When 125Hz; 0.5 secs. 0.5secs. 2 secs. □1 → 25 → □□	Hz
	LEV-A opening pulse 0~500	0~500 (When it is 100 pulse or more, hundreds digit, tens digit and ones digit are displayed by turns.) (Example) When 150 pulse; 0.5 secs. 0.5secs. 2 secs. □1 → 50 → □□	Pulse

* SW1-8 : OFF (Unit: °C), SW1-8 : ON (Unit: °F)



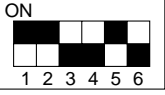
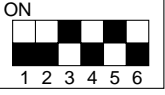
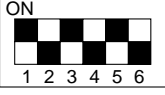
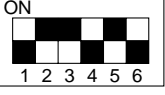
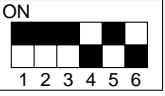
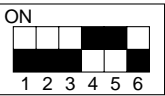
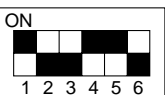
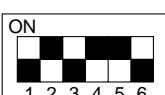

SW2 setting	Display detail	Explanation for display	Unit														
	LEV-B opening pulse 0~500	0~500 (When it is 100 pulse or more, hundreds digit, tens digit and ones digit are displayed by turns. (Example) When 150 pulse; 0.5 secs. 0.5secs. 2 secs. □1 →50 →□□	Pulse														
	LEV-C opening pulse 0~500	0~500 (When it is 100 pulse or more, hundreds digit, tens digit and ones digit are displayed by turns. (Example) When 150 pulse; 0.5 secs. 0.5secs. 2 secs. □1 →50 →□□	Pulse														
	LEV-D opening pulse 0~500	0~500 (When it is 100 pulse or more, hundreds digit, tens digit and ones digit are displayed by turns. (Example) When 150 pulse; 0.5 secs. 0.5secs. 2 secs. □1 →50 →□□	Pulse														
	LEV-E opening pulse 0~500	0~500 (When it is 100 pulse or more, hundreds digit, tens digit and ones digit are displayed by turns. (Example) When 150 pulse; 0.5 secs. 0.5secs. 2 secs. □1 →50 →□□	Pulse														
	Capacity setting indoor-A	<table border="1"> <thead> <tr> <th>Code display (Not Qj)</th> <th>Rated capacity</th> </tr> </thead> <tbody> <tr> <td>2</td> <td>06</td> </tr> <tr> <td>3</td> <td>09</td> </tr> <tr> <td>6</td> <td>12</td> </tr> <tr> <td>8</td> <td>15</td> </tr> <tr> <td>9</td> <td>17, 18</td> </tr> <tr> <td>11</td> <td>24</td> </tr> </tbody> </table>	Code display (Not Qj)	Rated capacity	2	06	3	09	6	12	8	15	9	17, 18	11	24	Code display
Code display (Not Qj)	Rated capacity																
2	06																
3	09																
6	12																
8	15																
9	17, 18																
11	24																
	Capacity setting indoor-B	Code display															
	Capacity setting indoor-C	Code display															
	Capacity setting indoor-D	Code display															
	Capacity setting indoor-E	Code display															
	Indoor pipe temperature / Liquid TH2 Indoor-A – 39~88 (°C) – 38~190 (°F)*	– 39~88 (°C), – 38~190 (°F) (When the temperature is 0°C or less, “-” and temperature are displayed by turns.)	°C °F(*)														

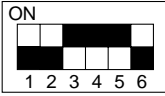
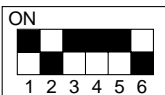



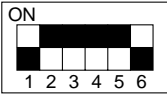
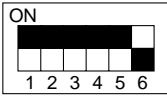
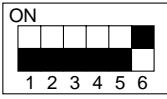
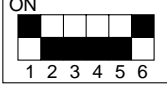
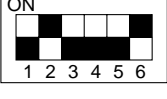
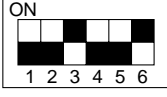
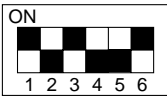
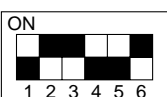
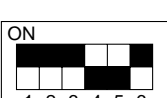

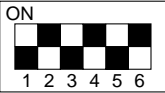

* SW1-8 : OFF (Unit: °C), SW1-8 : ON (Unit: °F)

SW2 setting	Display detail	Explanation for display	Unit
	Indoor pipe temperature / Liquid TH2 Indoor-B – 35~88 (°C) – 31~190 (°F)*	– 35~88 (°C), – 31~190 (°F) (When the temperature is 0°C or less, “–” and temperature are displayed by turns.)	°C °F(*)
	Indoor pipe temperature / Liquid TH2 Indoor-C – 39~88 (°C) – 38~190 (°F)*	– 39~88 (°C), – 38~190 (°F) (When the temperature is 0°C or less, “–” and temperature are displayed by turns.)	°C °F(*)
	Indoor pipe temperature / Liquid TH2 Indoor-D – 39~88 (°C) – 38~190 (°F)*	– 39~88 (°C), – 38~190 (°F) (When the temperature is 0°C or less, “–” and temperature are displayed by turns.)	°C °F(*)
	Indoor pipe temperature / Liquid TH2 Indoor-E – 39~88 (°C) – 38~190 (°F)*	– 39~88 (°C), – 38~190 (°F) (When the temperature is 0°C or less, “–” and temperature are displayed by turns.)	°C °F(*)
	LEV-1 opening pulse 0~500	0~500	Pulse
	LEV-2 opening pulse 0~500	0~500	Pulse
	LEV-3 opening pulse 0~500	0~500	Pulse
	LEV-4 opening pulse 0~500	0~500	Pulse
	LEV-5 opening pulse 0~500	0~500	Pulse
	Outdoor pipe temperature / 2-phase (TH6) – 39~88 (°C) – 38~190 (°F)*	– 39~88 (°C), – 38~190 (°F) (When the temperature is 0°C or less, “–” and temperature are displayed by turns.)	°C °F(*)
	Outdoor outside temperature (TH7) – 39~88 (°C) – 38~190 (°F)*	– 39~88 (°C), – 38~190 (°F) (When the temperature is 0°C or less, “–” and temperature are displayed by turns.)	°C °F(*)

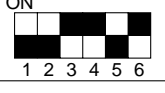
* SW1-8 : OFF (Unit: °C), SW1-8 : ON (Unit: °F)

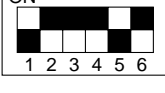
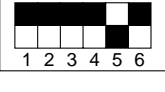
SW2 setting	Display detail	Explanation for display	Unit
	Outdoor heatsink temperature (TH8) – 40~200 (°C) – 40~327 (°F)*	– 40~200 (°C), – 40~327 (°F) (When the temperature is 0°C or less, “-” and temperature are displayed by turns.) (When the thermistor detects 100°C or more, hundreds digit, tens digit and ones digit are displayed by turns.)	°C °F
	LEV-6 opening pulse 0~500	0~500	Pulse
	LEV-7 opening pulse 0~500	0~500	Pulse
	LEV-8 opening pulse 0~500	0~500	Pulse
	High pressure (63HS) 0~500 (0.1 kgf/cm²) 0~711 (PSIG)*	0~500 (0.1 kgf/cm²), 0~711 (PSIG) (When it is 100 or more, hundreds digit, tens digit and ones digit are displayed by turns.)	0.1 kgf/cm² PSIG(*)
	Input current 0~50	0~50	A
	Indoor pipe temperature / Cond. / Eva. TH5 Indoor-A	– 39~88 (°C) – 38~190 (°F)*	°C °F(*)
	Indoor pipe temperature / Cond. / Eva. TH5 Indoor-B	– 39~88 (°C) – 38~190 (°F)*	°C °F(*)
	Indoor pipe temperature / Cond. / Eva. TH5 Indoor-C	– 39~88 (°C) – 38~190 (°F)*	°C °F(*)
	Indoor pipe temperature / Cond. / Eva. TH5 Indoor-D	– 39~88 (°C) – 38~190 (°F)*	°C °F(*)
	Indoor pipe temperature / Cond. / Eva. TH5 Indoor-E	– 39~88 (°C) – 38~190 (°F)*	°C °F(*)

* SW1-8 : OFF (Unit: °C, 0.1 kgf/cm²), SW1-8 : ON (Unit: °F, PSIG)

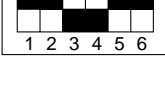
SW2 setting	Display detail	Explanation for display	Unit
	Branch pipe temperature TH-A	- 39~88 (°C) - 38~190 (°F)*	°C °F(*)
	Branch pipe temperature TH-B	- 39~88 (°C) - 38~190 (°F)*	°C °F(*)
	Branch pipe temperature TH-C	- 39~88 (°C) - 38~190 (°F)*	°C °F(*)
	Branch pipe temperature TH-D	- 39~88 (°C) - 38~190 (°F)*	°C °F(*)
	Branch pipe temperature TH-E	- 39~88 (°C) - 38~190 (°F)*	°C °F(*)
	TH1 Indoor-A	8~39 (°C) 46~102 (°F)*	°C °F(*)
	TH1 Indoor-B	8~39 (°C) 46~102 (°F)*	°C °F(*)
	TH1 Indoor-C	8~39 (°C) 46~102 (°F)*	°C °F(*)
	TH1 Indoor-D	8~39 (°C) 46~102 (°F)*	°C °F(*)
	TH1 Indoor-E	8~39 (°C) 46~102 (°F)*	°C °F(*)

* SW1-8 : OFF (Unit: °C), SW1-8 : ON (Unit: °F)



SW2 setting	Display detail	Explanation for display	Unit
	Indoor - setting temperature Indoor-A	16~31 (°C) 60~87 (°F)*	°C °F(*)
	Indoor - setting temperature Indoor-B	16~31 (°C) 60~87 (°F)*	°C °F(*)
	Indoor - setting temperature Indoor-C	16~31 (°C) 60~87 (°F)*	°C °F(*)
	Indoor - setting temperature Indoor-D	16~31 (°C) 60~87 (°F)*	°C °F(*)
	Indoor - setting temperature Indoor-E	16~31 (°C) 60~87 (°F)*	°C °F(*)

* SW1-8 : OFF (Unit: °C), SW1-8 : ON (Unit: °F)

8-9. SELECTING FUNCTIONS USING THE REMOTE CONTROLLER

Each function can be set according to necessity using the remote controller. The setting of function for each unit can only be done by the remote controller. Select function available from the table 1.

(1) Functions available when setting the unit number to 00

※1 The functions table below are available only when P-series indoor unit and the wired remote controller is used.

※2 After the power supply returns, the indoor unit does not operate for 3 minutes (Some kind of indoor units operate for 30 seconds, after that, it stops for 3 minutes).

Above operation is normal.

<Table 1> Function selections

Function	Settings	Mode No.	Setting No.	● : Initial setting (when sent from the factory)	Remarks
Power failure automatic recovery	OFF	01	1		The setting is applied to all the units in the same refrigerant system.
	ON ※2		2	●	
Indoor temperature detecting	Average data from each indoor unit	02	1	●	
	Data from the indoor unit with remote controller		2		
	Data from main remote controller		3		
LOSSNAY connectivity	Not supported	03	1	●	
	Supported (Indoor unit does not intake outdoor air through LOSSNAY)		2		
	Supported (Indoor unit intakes outdoor air through LOSSNAY)		3		
Power supply voltage	230V	04	1	●	
	208V		2		
Frost prevention temperature	2°C [36°F](Normal)	15	1	●	
	3°C [37°F]		2		
Humidifier control	When the compressor operates, the humidifier also operates.	16	1	●	
	When the fan operates, the humidifier also operates.		2		

Meaning of "Function setting"

Mode02:indoor temperature detecting

No	Indoor temperature(ta)=					
No.1	Average data of the sensor on all the indoor units	Initial setting	$ta=(A+B)/2$	$ta=(A+B)/2$	$ta=A$	$ta=A$
No.2	The data of the sensor on the indoor unit that is connected with remote controller		$ta=A$	$ta=B$	$ta=A$	$ta=A$
No.3	The data of the sensor on main remote controller		$ta=C$	$ta=C$	$ta=C$	$ta=C$

9

PRECAUTIONS AGAINST REFRIGERANT LEAKAGE

The installer and system specialist shall secure safety against leakage according to local regulations or standards. The following standards may be applicable if local regulations are not available.

9-1. INTRODUCTION

R410A refrigerant of this air conditioner is non-toxic and non-flammable but leaking of large amount from an indoor unit into the room where the unit is installed may be deleterious.

To prevent possible injury, the rooms should be large enough to keep the R410A concentration specified by KHK : (a high pressure gas safety association) installation guidelines S0010 as follows.

* Maximum concentration
 Maximum refrigerant concentration of R410A of a room is 0.30 kg/m³ accordance with the installation guidelines.
 To facilitate calculation, the maximum concentration is expressed in units of kg/m³ (kg of R410A per m³)

Maximum concentration of R410A: 0.3kg/m³[0.019lbs/ft³]
 (KHK installation guidelines S0010)

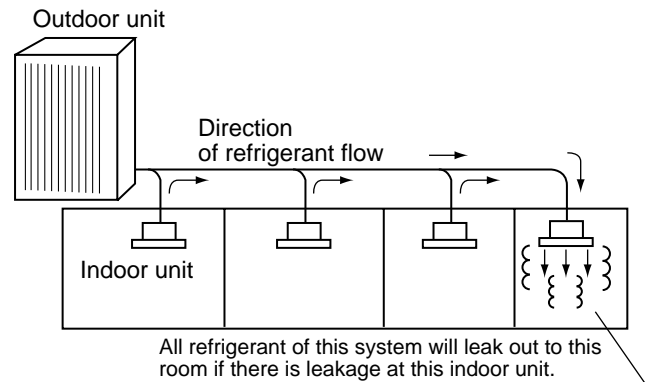

9-2. CONFIRMING PROCEDURE OF R410A CONCENTRATION

Follow (1) to (3) to confirm the R410A concentration and take appropriate treatment, if necessary.

(1) Calculate total refrigerant amount by each refrigerant system.

Total refrigerant amount is precharged refrigerant amount at ex-factory plus additional charged amount at field installation.

Note:
 When single refrigeration system is consists of several independent refrigeration circuit, figure out the total refrigerant amount by each independent refrigerant circuit.

(2) Calculate room volumes (m³[ft³]) and find the room with the smallest volume

The part with represents the room with the smallest volume.

(a) Situation in which there are no partitions

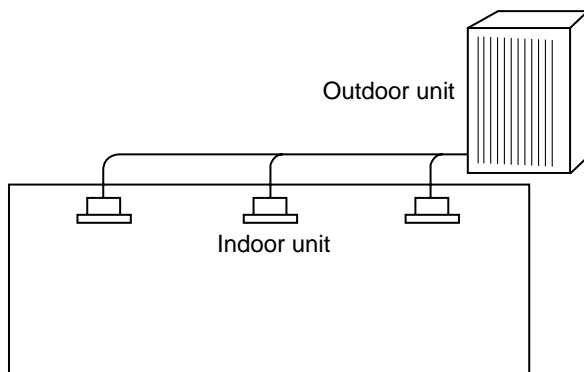

(b) There are partitions, but there are openings that allow the effective mixing of air.

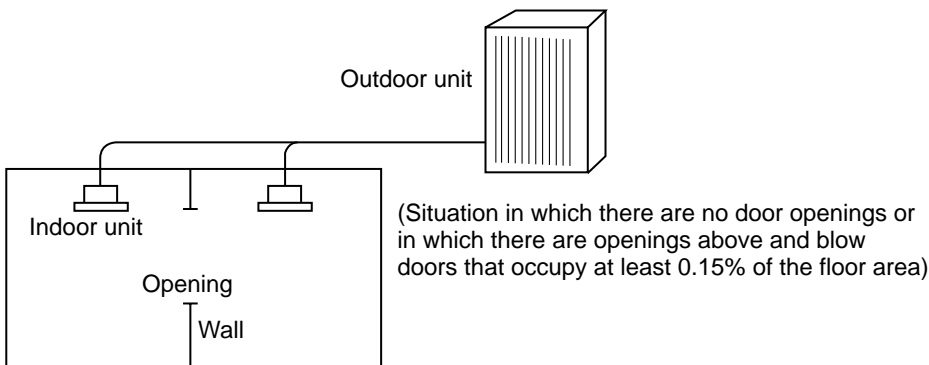

(c) If the smallest room has mechanical ventilation

Apparatus that is linked to a household gas detection and alarm device, the calculations should be performed for the second smallest room.

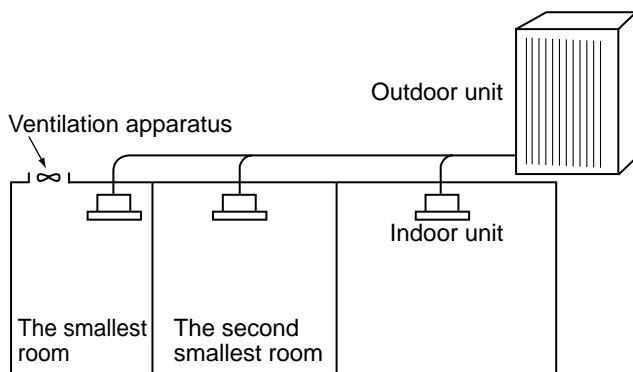

(3) Use the results of calculations (1) and (2) to calculate the refrigerant concentration:

$$\frac{\text{Total refrigerant in the refrigerating unit (kg[lbs])}}{\text{The smallest room in which an indoor unit has been installed (m}^3\text{[ft}^3\text{])}} \leq \text{maximum concentration (kg/m}^3\text{[lbs/ft}^3\text{])}$$

Maximum concentration of R410A: 0.3kg/m³[0.019 lbs/ft³]

If the calculation results do not exceed the maximum concentration, perform the same calculations for the larger second and third room, etc., until it has been determined that nowhere will the maximum concentration be exceeded.

OUTDOOR UNIT : MXZ-8B48NA

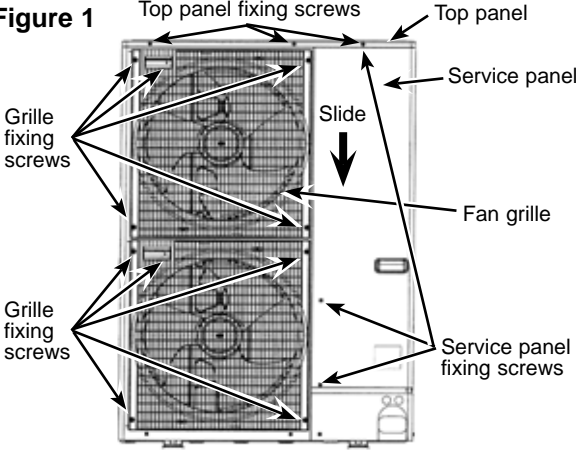
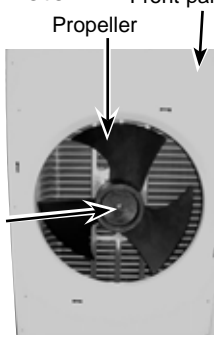
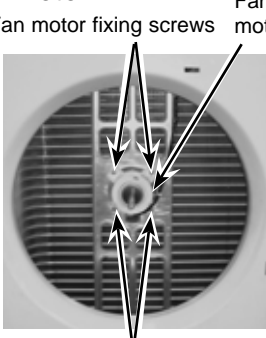
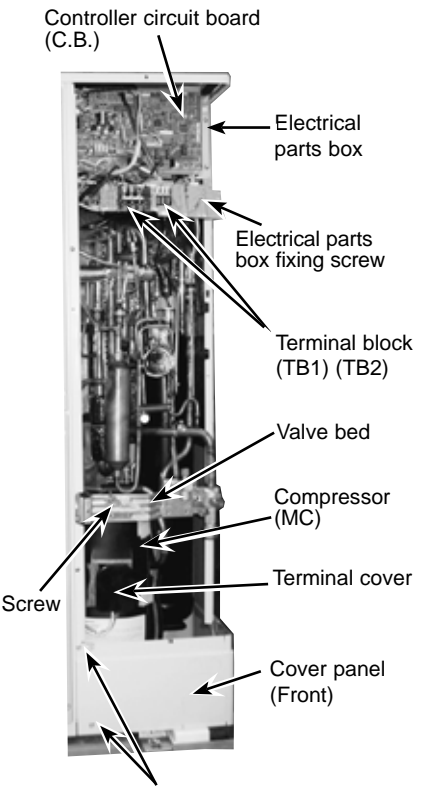
OPERATING PROCEDURE	PHOTOS & ILLUSTRATION
<p>1. Removing the service panel and top panel</p> <p>(1) Remove 3 service panel fixing screws (5 × 10) and slide the hook on the right downward to remove the service panel.</p> <p>(2) Remove screws (3 for front, 3 for rear/5 × 10) of the top panel and remove it.</p>	<p>Figure 1</p> 
<p>2. Removing the fan motor (MF1, MF2)</p> <p>(1) Remove the service panel. (See Figure 1)</p> <p>(2) Remove the top panel. (See Figure 1)</p> <p>(3) Remove 5 fan grille fixing screws (5 × 10) to detach the fan grille. (See Figure 1)</p> <p>(4) Remove a nut (for right handed screw of M6) to detach the propeller. (See Photo 1)</p> <p>(5) Disconnect the connectors, CNF1 and CNF2 on controller circuit board in electrical parts box.</p> <p>(6) Remove 4 fan motor fixing screws (5 × 25) to detach the fan motor. (See Photo 2)</p>	<p>Photo 1</p>  <p>Photo 2</p> 
<p>3. Removing the electrical parts box</p> <p>(1) Remove the service panel. (See Figure 1)</p> <p>(2) Remove the top panel. (See Figure 1)</p> <p>(3) Disconnect the indoor/outdoor connecting wire and power supply wire from each terminal block.</p> <p>(4) Remove all the following connectors from controller circuit board; fan motor, thermistor <Outdoor pipe>, thermistor <Discharge>, thermistor <Outdoor 2-phase pipe>, thermistor <Outdoor>, high pressure switch, high pressure sensor, low pressure switch, solenoid valve coil <4-way valve> and solenoid valve coil <Hot gas bypass>, solenoid valve coil <Returning oil bypass>.</p> <p>Then remove a screw (4 × 8) from the valve bed to remove the lead wire.</p> <p>Pull out the disconnected wire from the electrical parts box.</p> <p><Diagram symbol in the connector housing></p> <ul style="list-style-type: none"> • Fan motor (CNF1, CNF2) • Thermistor <Outdoor pipe> (TH3) • Thermistor <Discharge> (TH4) • Thermistor <Outdoor 2-phase pipe, Outdoor> (TH7/6) • High pressure switch (63H) • High pressure sensor (63HS) • Low pressure switch (63L) • Solenoid valve coil <4-way valve> (21S4) • Solenoid valve coil <Bypass valve> (SV1) • Solenoid valve coil (Returning oil bypass) <Bypass valve> (SV2) <p>(5) Remove the terminal cover and disconnect the compressor lead wire.</p> <p>(6) Remove an electrical parts box fixing screw (4 × 10) and detach the electrical parts box by pulling it upward. The electrical parts box is fixed with 2 hooks on the left and 1 hook on the right.</p>	<p>Photo 3</p> 

OPERATING PROCEDURE

4. Removing the thermistor <Outdoor 2-phase pipe> (TH6)

- (1) Remove the service panel. (See Figure 1)
- (2) Remove the top panel. (See Figure 1)
- (3) Disconnect the connectors, TH6 and TH7 (red), on the controller circuit board in the electrical parts box.
- (4) Loosen the clamp for the lead wire in the rear of the electrical parts box.
- (5) Pull out the thermistor <Outdoor 2-phase pipe> (TH6) from the sensor holder.

Note: In case of replacing thermistor <Outdoor 2-phase pipe> (TH6), replace it together with thermistor <Outdoor> (TH7) since they are combined together. Refer to No.5 below to remove thermistor <Outdoor>.

PHOTOS

Photo 4

Controller circuit board (C.B.)

Thermistor
<Outdoor 2-phase pipe>
(TH6)

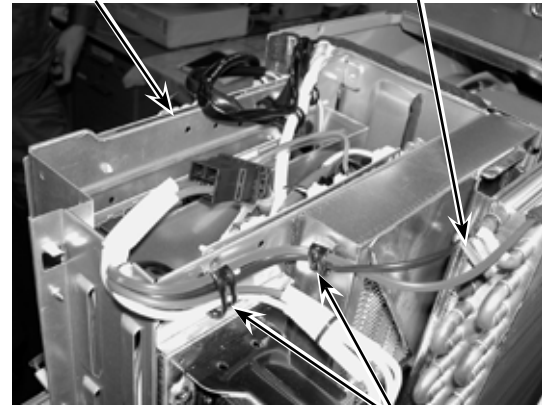

Clamp

5. Removing the thermistor <Outdoor> (TH7)

- (1) Remove the service panel. (See Figure 1)
- (2) Remove the top panel. (See Figure 1)
- (3) Disconnect the connector TH7 (red) on the controller circuit board in the electrical parts box.
- (4) Loosen the clamp for the lead wire in the rear of the electrical parts box. (See Photo 4)
- (5) Pull out the thermistor <Outdoor> (TH7) from the sensor holder.

Note: In case of replacing thermistor <Outdoor> (TH7), replace it together with thermistor <Outdoor 2-phase pipe> (TH6), since they are combined together. Refer to No.4 above to remove thermistor <Outdoor 2-phase pipe>.

Photo 5

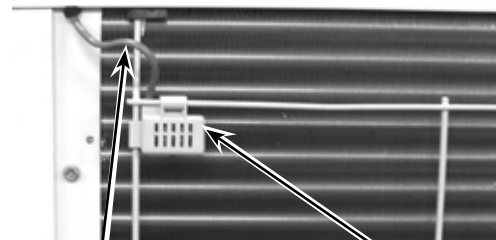

Lead wire of thermistor
<Outdoor> (TH7)

Sensor holder

6. Removing the thermistor <Outdoor pipe> (TH3) and thermistor <Discharge> (TH4)

- (1) Remove the service panel. (See Figure 1)
- (2) Disconnect the connectors, TH3 (white) and TH4 (white), on the controller circuit board in the electrical parts box.
- (3) Loosen the clamp for the lead wire in the rear of the electrical parts box. (See Photo 4)
- (4) Pull out the thermistor <Outdoor pipe> (TH3) and thermistor <Discharge> (TH4) from the sensor holder.

Photo 6

Thermistor <Outdoor pipe> (TH3)



Compressor (MC)

Thermistor <Discharge> (TH4)

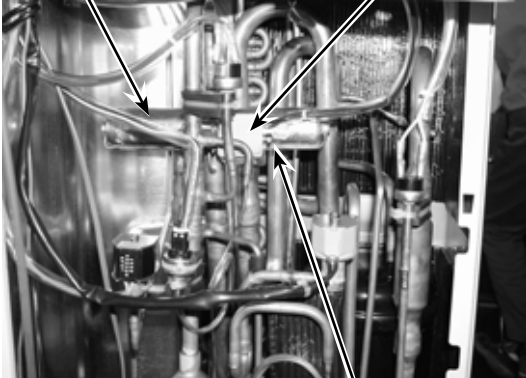
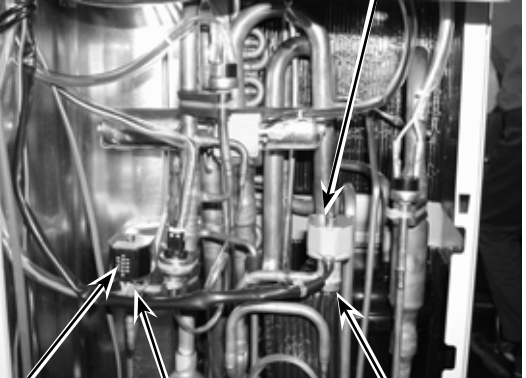

OPERATING PROCEDURE	PHOTOS
<p>7. Removing the solenoid valve coil <4-way valve> (21S4)</p> <ol style="list-style-type: none">(1) Remove the service panel. (See Figure 1)(2) Remove the top panel. (See Figure 1) <p>[Removing the solenoid valve coil <4-way valve>]</p> <ol style="list-style-type: none">(3) Remove 4-way valve solenoid coil fixing screw (M4 x 6).(4) Remove the solenoid valve coil <4-way valve> by sliding the coil toward you.(5) Disconnect the connector 21S4 (green) on the controller circuit board in the electrical parts box. <p>8. Removing the 4-way valve</p> <ol style="list-style-type: none">(1) Remove the service panel. (See Figure 1)(2) Remove the top panel. (See Figure 1)(3) Remove 3 valve bed fixing screws (4 x 10) and 4 ball valve and stop valve fixing screws (5 x 16) and then remove the valve bed.(4) Remove 4 right side panel fixing screws (5 x 10) in the rear of the unit and then remove the right side panel.(5) Remove the solenoid valve coil <4-way valve>. (See Photo 7)(6) Recover refrigerant.(7) Remove the welded part of 4-way valve. <p>Note 1: Recover refrigerant without spreading it in the air. Note 2: The welded part can be removed easily by removing the right side panel. Note 3: When installing the 4-way valve, cover it with a wet cloth to prevent it from heating (120°C [250°F] or more), then braze the pipes so that the inside of pipes are not oxidized.</p>	<p>Photo 7</p>  <p>4-way valve</p> <p>Solenoid valve coil <4-way valve> (21S4)</p> <p>Solenoid valve coil <4-way valve> fixing screw</p>
<p>9. Removing solenoid valve coil <Bypass valve> (SV1) and bypass valve</p> <ol style="list-style-type: none">(1) Remove the service panel. (See Figure 1)(2) Remove the top panel. (See Figure 1)(3) Remove the electrical parts box. (See Photo 4)(4) Remove 3 right side panel fixing screws (5 x 10) in the rear of the unit and remove the right side panel.(5) Remove the bypass valve coil fixing screw (M4 x 6).(6) Remove the solenoid valve coil <Bypass valve> (SV1) by sliding the coil upward.(7) Recover refrigerant.(8) Remove the welded part of bypass valve. <p>Note 1: Recover refrigerant without spreading it in the air. Note 2: The welded part can be removed easily by removing the right side panel.</p>	<p>Photo 8</p>  <p>Solenoid valve coil <Bypass valve> (Returning oil bypass) (SV2)</p> <p>Solenoid valve coil <Bypass valve> (SV1)</p> <p>Bypass valve (SV1)</p> <p>Bypass valve (SV2)</p>
<p>10. Removing solenoid valve coil (Returning oil bypass) <Bypass valve> (SV2) and bypass valve</p> <ol style="list-style-type: none">(1) Remove the service panel. (See Figure 1)(2) Remove the top panel. (See Figure 1)(3) Remove the electrical parts box. (See Photo 4)(4) Remove 3 right side panel fixing screws (5 x 10) in the rear of the unit and remove the right side panel.(5) Remove the bypass valve coil fixing screw (M5 x 6).(6) Remove the solenoid valve coil (Returning oil bypass) <Bypass valve> (SV2) by sliding the coil upward.(7) Recover refrigerant.(8) Remove the welded part of bypass valve. <p>Note 1: Recover refrigerant without spreading it in the air. Note 2: The welded part can be removed easily by removing the right side panel.</p>	

OPERATING PROCEDURE

11. Removing the high pressure switch (63H) and low pressure switch (63L)

- (1) Remove the service panel. (See Figure 1)
- (2) Remove the top panel. (See Figure 1)
- (3) Remove the electrical parts box. (See Photo 4)
- (4) Remove 3 right side panel fixing screws (5 × 10) in the rear of the unit and remove the right side panel.
- (5) Pull out the lead wire of high pressure switch and low pressure switch.
- (6) Recover refrigerant.
- (7) Remove the welded part of high pressure switch and low pressure switch.

Note 1: Recover refrigerant without spreading it in the air.

Note 2: The welded part can be removed easily by removing the right side panel.

Note 3: When installing the high pressure switch and low pressure switch, cover them with a wet cloth to prevent them from heating (100°C [210°F] or more), then braze the pipes so that the inside of pipes are not oxidized.

12. Removing the high pressure sensor (63HS)

- (1) Remove the service panel. (See Figure 1)
- (2) Remove the top panel. (See Figure 1)
- (3) Remove the electrical parts box. (See Photo 4)
- (4) Remove 3 right side panel fixing screws (5 × 10) in the rear of the unit and remove the right side panel.
- (5) Pull out the lead wire of high pressure sensor.
- (6) Recover refrigerant.
- (7) Remove the welded part of high pressure sensor.

Note 1: Recover refrigerant without spreading it in the air.

Note 2: The welded part can be removed easily by removing the right side panel.

Note 3: When installing the high pressure sensor, cover it with a wet cloth to prevent it from heating (100°C [210°F] or more), then braze the pipes so that the inside of pipes are not oxidized.

PHOTOS

Photo 9

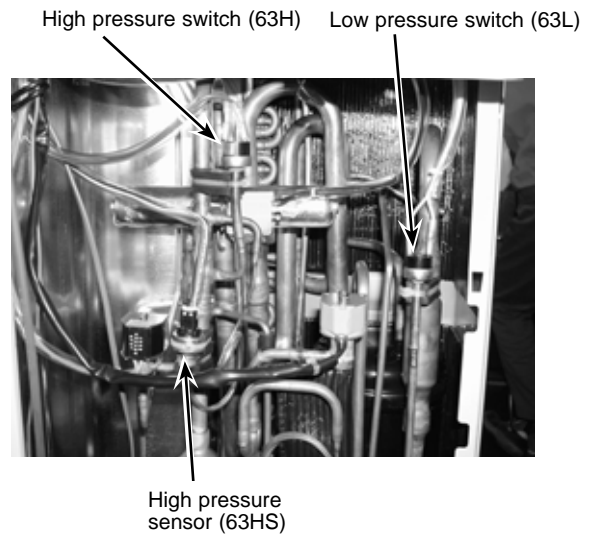

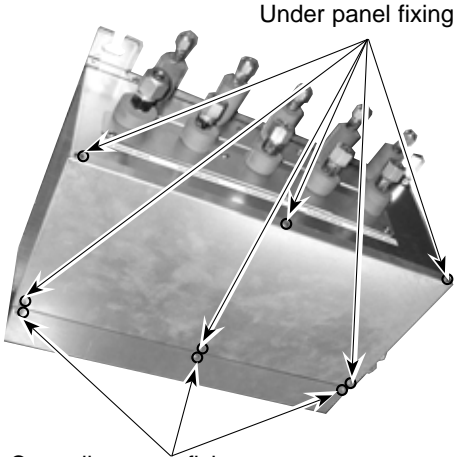
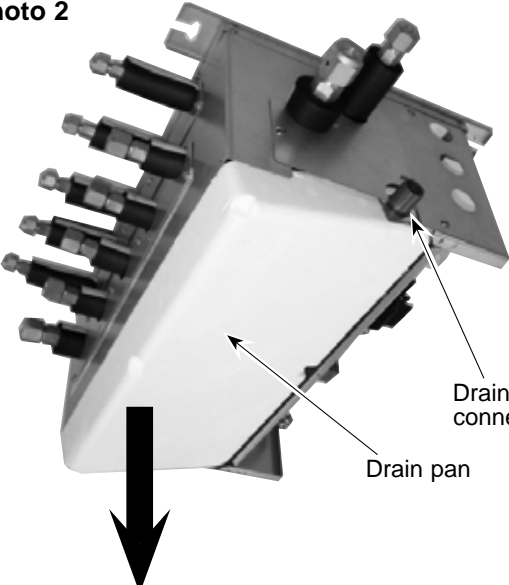
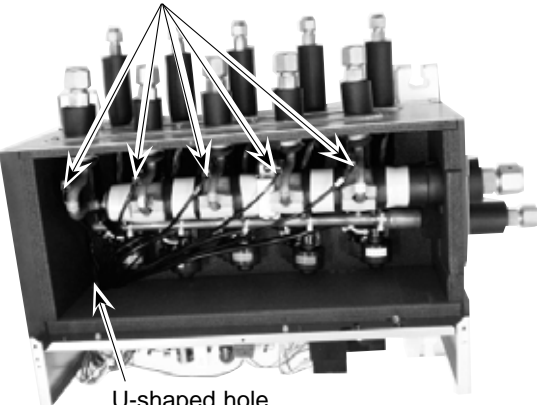
OPERATING PROCEDURE	PHOTOS
<p>1. Removing the controller cover and under panel</p> <p>(1) Remove 3 controller cover fixing screws (4 × 10) to detach the cover. (See Photo 1)</p> <p>(2) Remove 6 under panel fixing screws (4 × 10) to remove the panel. (See Photo 1)</p>	<p>Photo 1</p>  <p>Under panel fixing screws</p> <p>Controller cover fixing screws</p>
<p>2. Removing the drain pan</p> <p>(1) Remove the under panel. (See Photo 1)</p> <p>(2) Remove the drain hose.</p> <p>(3) Incline the side of the drain pan that faces the piping to remove the pan.</p> <p>※ When removing the drain pan, be careful with remaining water on the pan.</p> <p>Also, be careful not to make cracks on the pan.</p>	<p>Photo 2</p>  <p>Drain hose connection</p> <p>Drain pan</p>
<p>3. Removing the thermistors (TH-A-E)</p> <p>(1) Remove the controller cover. (See Photo 1)</p> <p>(2) Remove the under panel. (See Photo 1)</p> <p>(3) Pull out the thermistors, TH-A-E, from the sensor holders mounted on the gas pipe. (See Photo 3)</p> <p>(4) Pull out those thermistors through the U-shaped hole to the board side.</p> <p>(5) Loosen the side clamps of the board and disconnect the connectors on the board.</p>	<p>Photo 3</p>  <p>Sensor holder</p> <p>U-shaped hole</p>

OPERATING PROCEDURE

4. Removing the LEV coil (LEV-A-E)

- (1) Remove the controller cover. (See Photo 1)
- (2) Remove the under cover. (See Photo 1)
- (3) Remove 4 separator fixing screws (4 × 10) in the side of the branch box. (See Photo 4)
- (4) Tilt the separator to the board side. (See Photo 4)
- (5) Loosen the side clamps of the board and disconnect the connectors on the board.
- (6) Pull out the lead wire through the U-shaped hole. (See Photo 3)
- (7) Cut the band that fixes the lead wire to pull out the LEV coil (LEV-A-E). (See Photo 5)

PHOTOS

Photo 4

Separator fixing screws

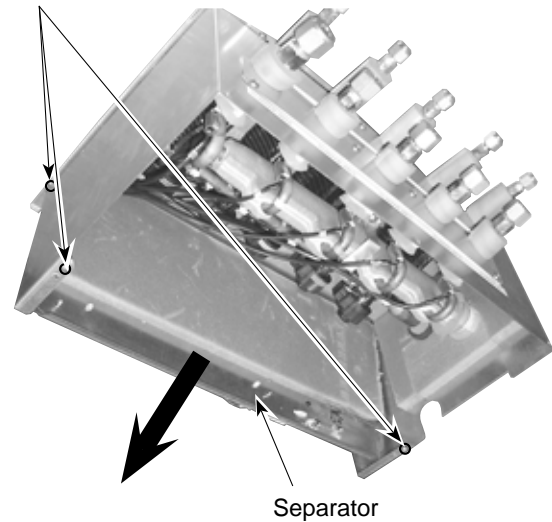

Photo 5

Separator

LEV coil



Band

 **MITSUBISHI ELECTRIC CORPORATION**

HEAD OFFICE : TOKYO BLDG., 2-7-3, MARUNOUCHI, CHIYODA-KU, TOKYO100-8310, JAPAN