

COMPANY LOYALTY

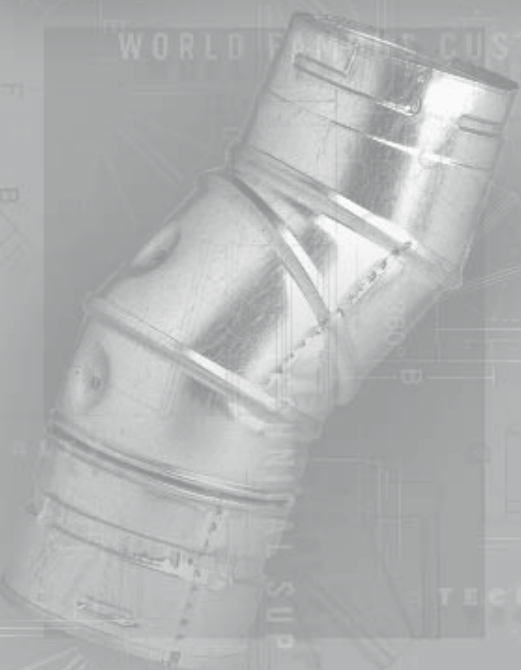

METAL-FAB[®] INC.

THE BEST TYPE-B GAS VENT IN THE INDUSTRY



FOR YOUR REFERENCE

MODELS "M" & "MO", TYPE B, GAS VENT

METAL-FAB ROUND AND OVAL TYPE-B GAS VENT IS LISTED BY UNDERWRITERS LABORATORIES, INC. FOR USE WITH APPROVED GAS FURNACES, HEATERS, FIREPLACES AND BOILERS. METAL-FAB MEETS OR EXCEEDS ALL RECOGNIZED GAS VENTING CODES, STANDARDS OR REQUIREMENTS, WHETHER LOCAL, STATE, OR UNITED STATES. MAXIMUM TEMPERATURE RATING FOR B-VENT IS 530° F.

1" Minimum clearance to combustibles for 3" through 24" diameters.

2" Minimum clearance to combustibles for 26" through 30" diameters.

Round pipe and fittings available in 3" through 30" diameters.

Oval pipe and fittings available in 4", 5", and 6" diameters.



Listed 441

MATERIAL SPECIFICATIONS

The outer wall is constructed of galvanized steel, .018" thick G-90 for sizes 3" to 14" diameter, and .024" thick G-90 for sizes 16" to 30" diameter.

The inner wall is constructed of aluminum alloy, .012" thick for sizes 3" to 8" diameter and .018" thick for sizes 10" to 30" diameter.

The vent includes an integral, annular insulating air space, 1/4" thick for sizes 3" to 6" diameter and 1/2" thick for sizes 7" to 30" diameter.

ADAPTABILITY

Metal-Fab round B-Vent has been evaluated and listed by Underwriters Laboratories, Inc., to mate with other specifically identified and UL listed round gas vent, in 3" through 6" diameters. Metal-Fab's approval covers connections at both the male (outlet) end, and the female (inlet) end to the following B-Vent products:

General Products Co., Inc. (Airjet)
American Metal Products Co. (Amerivent)
Hart & Cooley (Metlvent)
Household Manufacturing Inc. (Metalbestos & Airmate)
Mitchell Metal Products Inc. (Mitchvent)
Selkirk Metalbestos (Metalbestos)
Simpson Dura-Vent Inc. (Duravent)
ECCO Heating Products (ECCO Manufacturing)

At the male (outlet) end of compatible gas vent, add an adapter or adjustable length (M6A, M12A, or M18A) - then add sections of Metal-Fab pipe. At the female (inlet) end of compatible vent simply insert the male end of Metal-Fab B-Vent into the compatible gas vent and secure per instructions.

SURELOCK™ B-VENT LOCKING SYSTEM:

The design of the SureLock™ B-Vent Locking System is unique. The male end of the pipe features a square dimple, positioned in the exact location to match the tab that is located on the female end of the pipe. When the pipe is joined and twisted until it stops, the SureLock™ tab can be pushed into the square dimple, therefore creating a positive twist lock that cannot be twisted apart. So unique that a patent is pending.

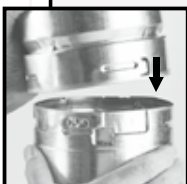

Line up the pipe ends.



Push the ends of the pipe together.



Twist to engage the twist lock.



Depress the SureLock™ tab to secure pipe sections.



To unlock, simply bend out the tab.

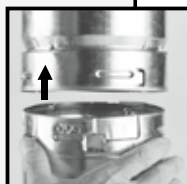

Untwist and pull pipe apart.

TYPE - B GAS VENT - ROUND PIPE

Note: Vent overlaps 1.5" when joined together. Therefore, assembled length is 1.5" less than listed length.

PIPE LENGTHS – 3M through 14M

With positive twist lock.

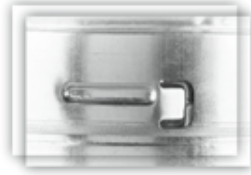

SureLock™ is standard on 3"-6" diameters.

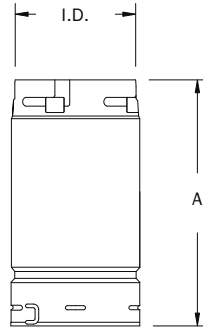

DIAMETER	6"	12"	18"	24"	36"	48"	60"
3" to 6"	X	X	X	X	X	X	X
7" to 10"		X	X	X	X	X	X
12" to 14"		X	X	X	X		

I.D. = 3" through 14" diameter.
A = Length. See chart for available lengths.

PIPE LENGTHS – 16M through 30M

With quick connect lock using sheet metal screws.

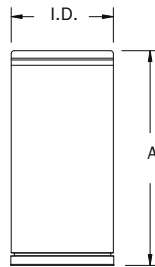
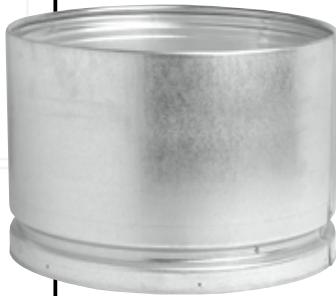

DIAMETER	6"	12"	18"	24"	36"	48"	60"
16" to 30"		X	X	X	X		

I.D. = 16" through 30" diameter.
A = Length. See chart for available lengths.

**ADJUSTABLE LENGTHS
M12A - M18A**

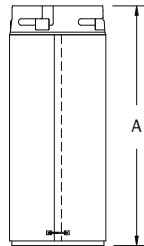

CAT. NO.	A	I.D.
M12A	Adjusts from 3" to 8"	3" through 30"
M18A	Adjusts from 3" to 14"	3" through 30"

ADAPTER – M6A

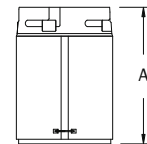

CAT. NO.	A	I.D.
M6A	6"	3" through 8"

ADAPTER – M6AF

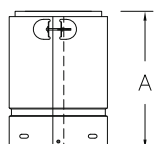

CAT. NO.	A	I.D.
M6AF	6.5"	3" through 6"

TYPE - B GAS VENT - ROUND FITTINGS

90° ADJUSTABLE ELBOW – M90 - 3" through 8"

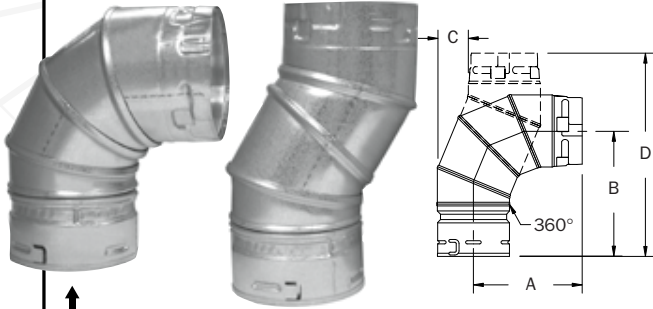

↑ SureLock™ is standard on 3"- 6" diameters.

CAT. NO.	SIZE	A	B	C	D
3M90	3"	4.750"	6.250"	1.750"	9.500"
4M90	4"	5.250"	6.250"	1.750"	9.500"
5M90	5"	6.000"	7.375"	2.250"	11.000"
6M90	6"	6.000"	7.812"	2.500"	11.000"
7M90	7"	7.750"	8.750"	3.125"	13.750"
8M90	8"	8.500"	9.000"	3.375"	14.500"

The five piece M90 short radius elbow is fully adjustable from 0° (straight) to 90°.

The 360° rotating collar allows for desired orientation of vent pipe.

45°/60° ADJUSTABLE ELBOW – M45/60 - 3" through 6" 45° ADJUSTABLE ELBOW – M45 - 7" and 8"

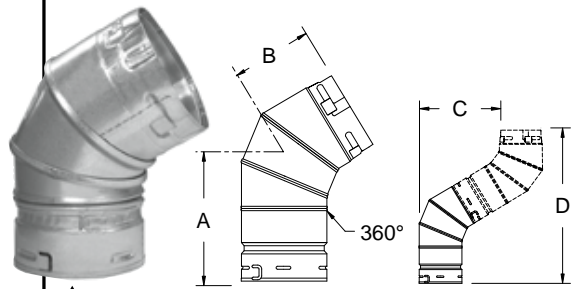

↑ SureLock™ is standard on 3"- 6" diameters.

CAT. NO.	SIZE	@ 45°				@ 60°	
		A	B	C	D	C	D
3M45/60	3"	4.528"	3.478"	4.601"	12.607"	5.754"	11.466"
4M45/60	4"	4.628"	3.528"	4.707"	12.863"	5.884"	11.691"
5M45/60	5"	5.859"	4.609"	6.342"	16.811"	7.896"	15.176"
6M45/60	6"	6.091"	4.391"	6.351"	16.832"	7.916"	15.211"
7M45	7"	5.500"	4.250"	5.798"	15.498"	N/A	N/A
8M45	8"	6.000"	4.500"	6.364"	16.864"	N/A	N/A

In sizes 3" through 6", the four piece M45/60 short radius elbow is fully adjustable from 0° (straight) to 60°.

In sizes 7" and 8", the elbow is adjustable from 0° to 45°.

The 360° rotating collar allows for desired orientation of vent pipe.

45° 2-PIECE ELBOW – M45 - 10", 12", 14", 16" 45° 3-PIECE ELBOW – M45 - 18" through 30"

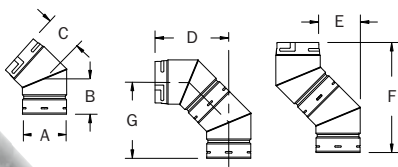

← Fixed 45° 2-piece elbow shown.

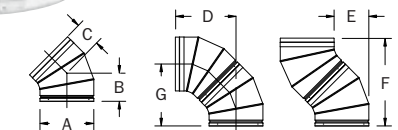

CAT. NO.	SIZE	A	B	C	D	E	F	G
10M45	10"	11.000"	7.500"	6.125"	14.75"	8.63"	22.25"	16.07"
12M45	12"	13.000"	7.630"	7.000"	16.25"	9.75"	23.88"	16.91"
14M45	14"	15.000"	8.250"	7.250"	17.25"	10.00"	25.38"	18.15"
16M45	16"	17.000"	7.000"	9.000"	19.43"	10.43"	26.43"	17.25"
18M45	18"	19.125"	10.790"	10.790"	24.99"	14.20"	35.78"	24.99"
20M45	20"	21.125"	10.790"	10.790"	24.99"	14.20"	35.78"	24.99"
22M45	22"	23.125"	10.790"	10.790"	24.99"	14.20"	35.78"	24.99"
24M45	24"	25.125"	10.790"	10.790"	24.99"	14.20"	35.78"	24.99"
26M45	26"	27.125"	11.950"	11.950"	27.78"	15.84"	39.72"	27.78"
28M45	28"	29.125"	11.950"	11.950"	27.78"	15.84"	39.72"	27.78"
30M45	30"	31.125"	11.950"	11.950"	27.78"	15.84"	39.72"	27.78"

Note: 10", 12", and 14" elbows are adjustable, and these same diameters have positive twist lock. Fixed angles in 16" through 30" diameter have quick connect lock using sheet metal screws.

SWIVEL TEE – MST - 3” through 6”

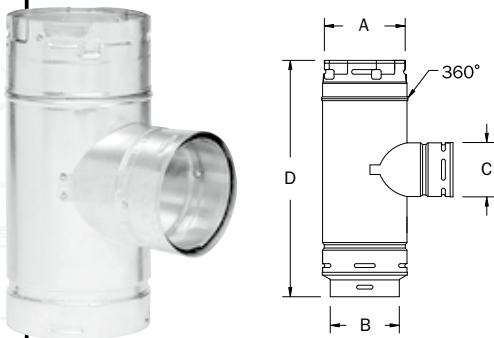

SureLock™ is standard on male end on 3"- 6" diameters.

CAT. NO.	SIZE	A	B	C	D
3M3ST3	3"	3.430"	3.500"	3.500"	9.940"
4M4ST4	4"	4.435"	4.505"	4.505"	10.920"
4M4ST3	4"	4.435"	4.505"	3.500"	9.940"
5M5ST5	5"	5.430"	5.500"	5.500"	11.530"
5M5ST4	5"	5.430"	5.500"	4.505"	10.920"
5M5ST3	5"	5.430"	5.500"	3.500"	9.940"
5M4ST4	5"	5.430"	4.505"	4.505"	12.170"
5M4ST3	5"	5.430"	4.505"	3.500"	11.190"
6M6ST6	6"	6.442"	6.510"	6.510"	12.410"
6M6ST5	6"	6.442"	6.510"	5.500"	11.530"
6M6ST4	6"	6.442"	6.510"	4.505"	10.920"
6M6ST3	6"	6.442"	6.510"	3.500"	9.940"
6M5ST4	6"	6.442"	5.500"	4.505"	12.170"
6M5ST3	6"	6.442"	5.500"	3.500"	11.190"

STANDARD TEE – MT - 7” through 30”

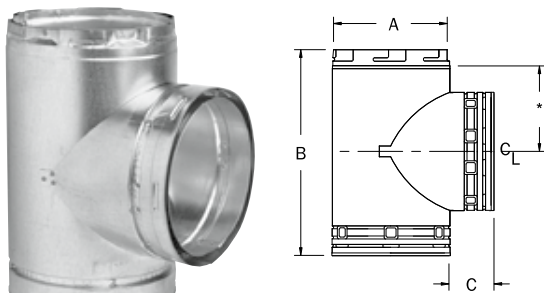

*Tap centered on installed body length

Tees in 7" through 14" diameter have positive twist lock.

Tees in 16" through 30" diameter use quick connect lock using sheet metal screws.

CAT. NO.	SIZE	A	B	C
7MT	7"	8.000"	13.75"	3"
8MT	8"	9.000"	14.75"	3"
10MT	10"	11.000"	19.00"	4"
12MT	12"	13.000"	21.00"	4"
14MT	14"	15.000"	23.00"	4"
16MT	16"	17.125"	28.50"	4"
18MT	18"	19.125"	30.50"	4"
20MT	20"	21.125"	32.50"	4"
22MT	22"	23.125"	34.50"	4"
24MT	24"	25.125"	36.50"	4"
26MT	26"	27.125"	38.50"	4"
28MT	28"	29.125"	40.50"	4"
30MT	30"	31.125"	42.50"	4"

SWIVEL WYE – MSY - 4” through 6”

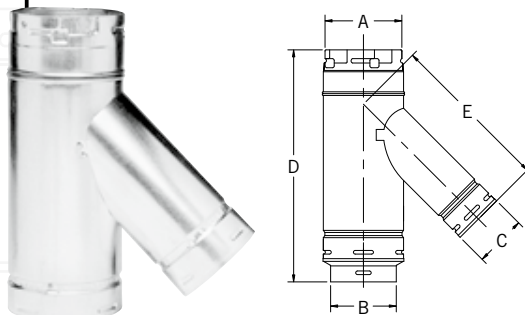

SureLock™ is standard on male end on 3"- 6" diameters.

CAT. NO.	SIZE	A	B	C	D	E
4M4SY4	4"	4.435"	4.505"	4.505"	14.50"	10.086"
4M4SY3	4"	4.435"	4.505"	3.500"	14.50"	10.581"
5M5SY4	5"	5.430"	5.500"	4.505"	14.50"	10.790"
5M5SY3	5"	5.430"	5.500"	3.500"	14.50"	11.285"
5M4SY4	5"	5.430"	4.505"	4.505"	15.75"	10.790"
5M4SY3	5"	5.430"	4.505"	3.500"	15.75"	11.285"
6M6SY5	6"	6.442"	6.510"	5.500"	15.75"	11.008"
6M6SY4	6"	6.442"	6.510"	4.505"	15.75"	11.505"
6M6SY3	6"	6.442"	6.510"	3.500"	15.75"	12.000"
6M5SY4	6"	6.442"	5.500"	4.505"	17.00"	12.000"
6M5SY3	6"	6.442"	5.500"	3.500"	17.00"	12.000"
6M4SY3	6"	6.442"	4.505"	3.500"	15.75"	12.000"

TYPE - B GAS VENT - ROUND FITTINGS

VENT CAP – MCHP - 3" through 6"

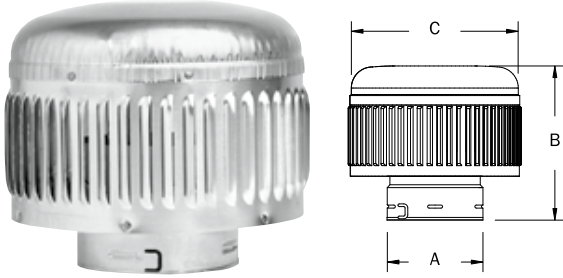

CAT. NO.	SIZE	A	B	C
3MCHP	3"	3.5"	8.0625"	5.50"
4MCHP	4"	4.5"	8.0000"	6.75"
5MCHP	5"	5.5"	8.5625"	10.00"
6MCHP	6"	6.5"	9.5625"	12.00"

SureLock™ is standard on 3"- 6" diameters.

VENT CAP – MC - 7" through 12"

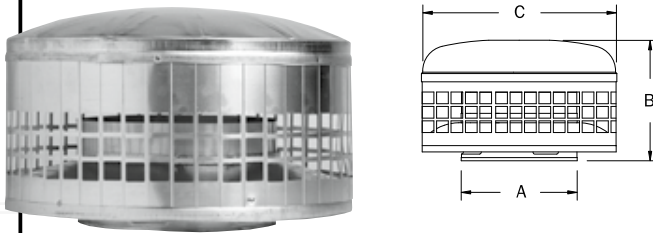

CAT. NO.	SIZE	A	B	C
7MC	7"	8"	8.00"	13.5"
8MC	8"	9"	9.25"	15.0"
10MC	10"	11"	11.00"	19.0"
12MC	12"	13"	11.00"	19.0"

With positive twist lock.

UNIVERSAL CAP – MCUHP - 3" through 6"

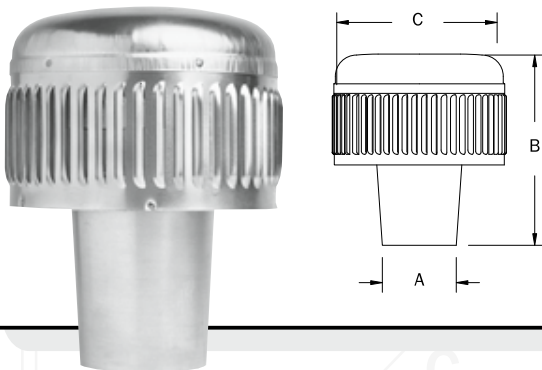

CAT. NO.	SIZE	A	B	C
3MCUHP	3"	2.75"	8.375"	5.50"
4MCUHP	4"	3.75"	11.000"	6.75"
5MCUHP	5"	4.75"	11.250"	10.00"
6MCUHP	6"	5.50"	12.000"	12.00"

TYPE - B GAS VENT - ROUND FITTINGS

UNIVERSAL CAP – MCU - 7" and 8"

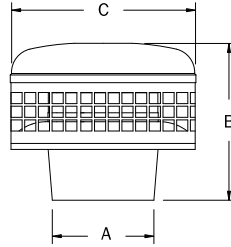

CAT. NO.	SIZE	A	B	C
7MCU	7"	6.75"	9.75"	13.5"
8MCU	8"	7.75"	11.50"	15.0"

VENT CAP – MC - 14" through 30"

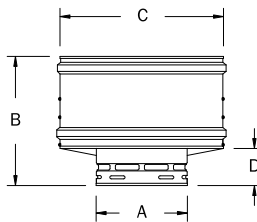

CAT. NO.	SIZE	A	B	C	D
14MC	14"	15"	23.25"	28.62"	5.62"
16MC	16"	17"	22.50"	30.62"	7.00"
18MC	18"	19"	24.50"	32.87"	7.00"
20MC	20"	21"	29.00"	39.00"	5.75"
22MC	22"	23"	29.50"	41.50"	8.00"
24MC	24"	25"	31.50"	43.50"	8.00"
26MC	26"	27"	35.50"	50.25"	6.00"
28MC	28"	29"	36.50"	52.25"	7.50"
30MC	30"	31"	37.00"	54.25"	7.50"

Note: 14" has positive twist lock.
16" - 30" has quick connect lock.

TYPE - B GAS VENT - ROUND FITTINGS

NO-HEIGHT INCREASER - MIN

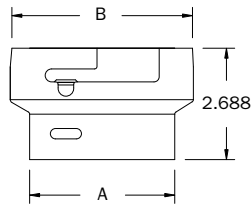

CAT. NO.	A	B
3MIN4	3"	4"
4MIN5	4"	5"
5MIN6	5"	6"

INCREASERS - Mix

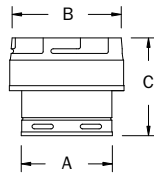

4" through 14"

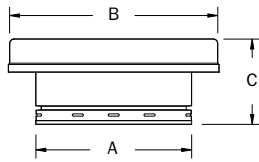

16" through 30"

CAT. NO.	4"-14"			CAT. NO.	16"-30"		
	A	B	C		A	B	C
3Mix5	3"	x 5"	6.5"	?Mix16	Specified	x 16"	8.5"
4Mix6	4"	x 6"	6.5"	?Mix18	Specified	x 18"	8.5"
?Mix7	Specified	x 7"	8.5"	?Mix20	Specified	x 20"	8.5"
?Mix8	Specified	x 8"	8.5"	?Mix22	Specified	x 22"	8.5"
?Mix10	Specified	x 10"	8.5"	?Mix24	Specified	x 24"	8.5"
?Mix12	Specified	x 12"	8.5"	?Mix26	Specified	x 26"	8.5"
?Mix14	Specified	x 14"	8.5"	?Mix28	Specified	x 28"	8.5"
				?Mix30	Specified	x 30"	8.5"

MOTOR HOUSING ADAPTERS

AD

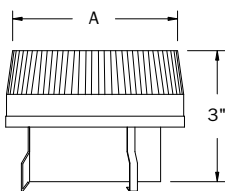

MA

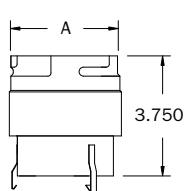

For connection to plastic motor housing.

CAT. NO.	A
3AD4	3.812"
3AD5	4.812"
3MA3	3.430"
3MA4	4.435"
3MA5	5.430"
4MA4	4.435"

AD With Single Wall Outlet
MA With Double Wall Outlet

TYPE - B GAS VENT - ROUND FITTINGS

DRAFTHOOD CONNECTOR – MDC

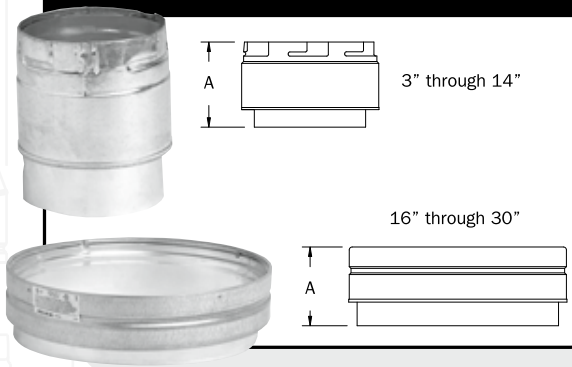

CAT. NO.	SIZE	A	CAT. NO.	SIZE	A
3MDC	3"	4.875"	16MDC	16"	5.000"
4MDC	4"	4.875"	18MDC	18"	5.000"
5MDC	5"	4.875"	20MDC	20"	5.000"
6MDC	6"	4.875"	22MDC	22"	5.000"
7MDC	7"	4.875"	24MDC	24"	5.000"
8MDC	8"	4.875"	26MDC	26"	5.000"
10MDC	10"	4.875"	28MDC	28"	5.000"
12MDC	12"	4.875"	30MDC	30"	5.000"
14MDC	14"	4.875"			

EASYOUT™ DRAFTHOOD CONNECTOR – 4MDC-CB

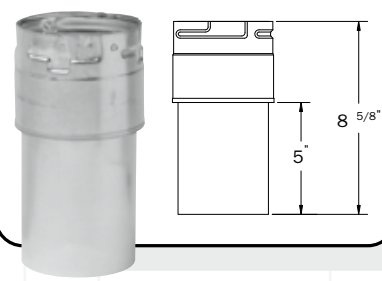

Connects to a furnace's internal vent elbow and exits the cabinet, where B-Vent can then be connected.

Designed for specific Carrier, Bryant and Payne gas furnaces, see spec sheet for models.

DRAFTHOOD INCREASER – 3MDC4

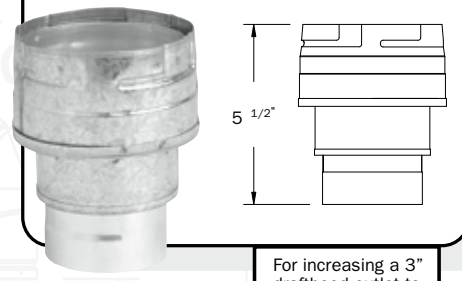

For increasing a 3" drafthood outlet to a 4" B-Vent outlet.

SINGLE WALL FLEX CONNECTORS MSWF - 3" through 5"

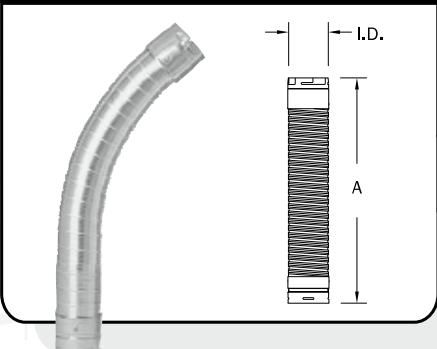

CAT. NO.	SIZE	A
MSWF03	3"	1',2',3',4',5'
MSWF04	4"	1',2',3',4',5'
MSWF05	5"	1',2',3',4',5'

For easy connection of appliance to common B-Vent.

B-FLEX FLEXIBLE B-VENT MDWF - 3" through 6"

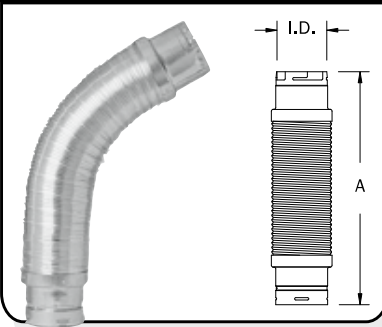

CAT. NO.	SIZE	A
MDWF03	3"	2',3',4',5'
MDWF04	4"	2',3',4',5'
MDWF05	5"	2',3',4',5'
MDWF06	6"	2',3',4',5'

Use as a connection of appliance to common B-Vent or as a segment of B-Vent except where it penetrates the structure; walls, floors, ceilings, roof.

PARTITION THIMBLE – MPT - 3" through 8"

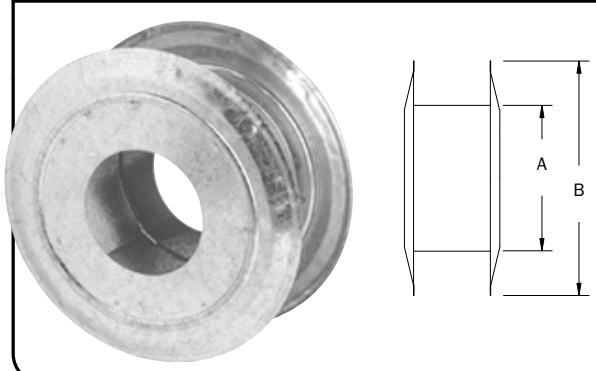

CAT. NO.	SIZE	A	B
3MPT	3"	5.6250"	9.00"
4MPT	4"	6.6875"	9.00"
5MPT	5"	7.6875"	11.00"
6MPT	6"	8.6875"	11.00"
7MPT	7"	10.1875"	13.25"
8MPT	8"	11.1875"	14.00"

Adjusts from 4.0" to 6.5" for variable wall thickness.

TYPE - B GAS VENT - ROUND FITTINGS

HANGER/WALL BAND – MH

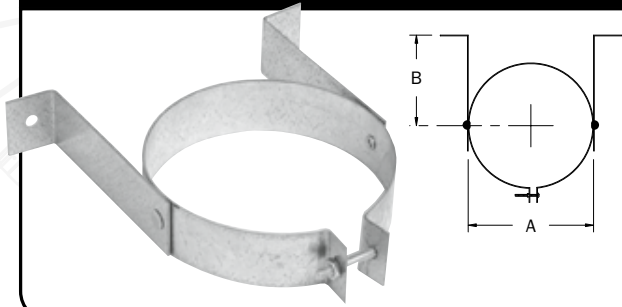

CAT. NO.	SIZE	A	B
3MH	3"	3.625"	3.218"
4MH	4"	4.625"	3.718"
5MH	5"	5.625"	4.218"
6MH	6"	6.625"	4.718"

7MWB and 8MWB still available - see price sheet.

FIRESTOP – MFS

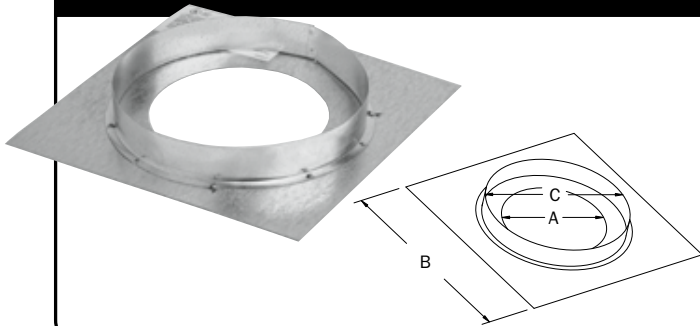

CAT. NO.	SIZE	A	B	C
3MFS	3"	3.563"	8.5"	5.5"
4MFS	4"	4.563"	8.5"	6.5"
5MFS	5"	5.563"	10.5"	7.5"
6MFS	6"	6.563"	10.5"	8.5"
7MFS	7"	8.063"	13.0"	10.0"
8MFS	8"	9.063"	13.0"	11.0"

Space ring attached to plate ensures 1" clearance to combustible.

SUREGRIP™ VENT SUPPORT PLATE - MVSP

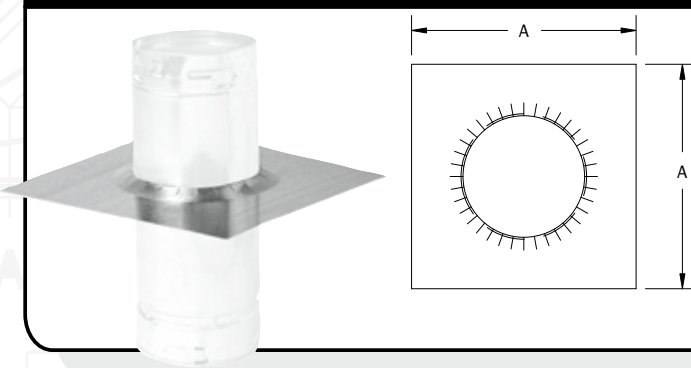

CAT. NO.	SIZE	A
2MVSP	2"	7"
3MVSP	3"	8"
4MVSP	4"	10"
5MVSP	5"	11"
6MVSP	6"	12"
7MVSP	7"	13"
8MVSP	8"	14"

The fastest, easiest way to support B-Vent where it penetrates floors and ceilings.

NOTE: Pipe not included.

SUREGRIP™ VENT SUPPORT PLATE ADJUSTABLE - MVSPA

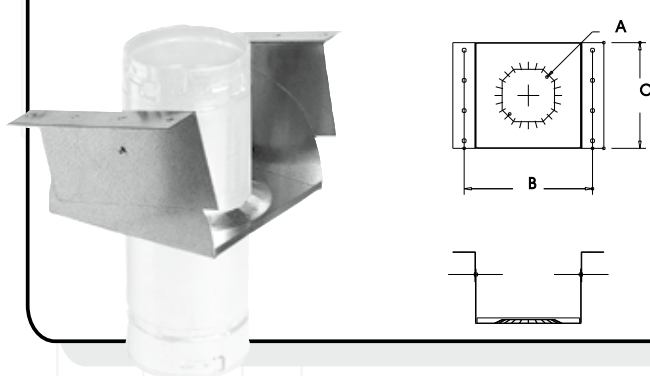

CAT. NO.	SIZE	A	B	C
3MVSPA	3"	3.475"	7.500"	6.000"
4MVSPA	4"	4.475"	8.500"	7.000"
5MVSPA	5"	5.448"	9.500"	8.000"
6MVSPA	6"	6.448"	10.500"	9.000"

NOTE: Pipe not included.

TEE CAP – MTC

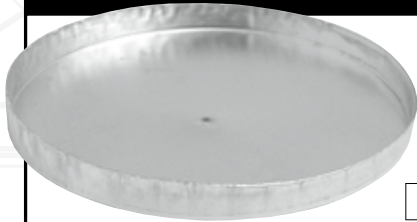

Sizes 3" through 30".

Use to cap flue when tee has no bottom (inlet) entry.

SUPPORT PLATE – MSP

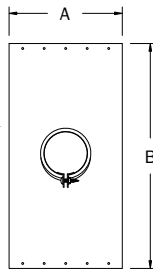
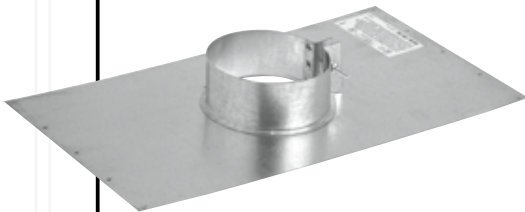

CAT. NO.	SIZE	A	B	CAT. NO.	SIZE	A	B
3MSP	3"	8.5"	17.0"	16MSP	16"	21.5"	21.5"
4MSP	4"	9.5"	17.0"	18MSP	18"	23.5"	24.0"
5MSP	5"	10.5"	17.0"	20MSP	20"	25.5"	30.0"
6MSP	6"	12.0"	17.0"	22MSP	22"	27.5"	30.0"
7MSP	7"	13.5"	17.0"	24MSP	24"	29.5"	30.0"
8MSP	8"	13.5"	17.0"	26MSP	26"	31.5"	36.0"
10MSP	10"	15.5"	17.0"	28MSP	28"	33.5"	36.0"
12MSP	12"	17.5"	21.5"	30MSP	30"	35.0"	36.0"
14MSP	14"	19.5"	21.5"				

HEAVY SUPPORT – MHS - 10" through 30"

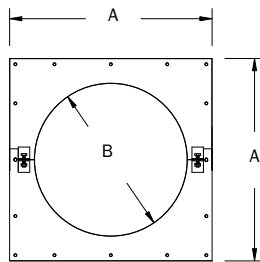
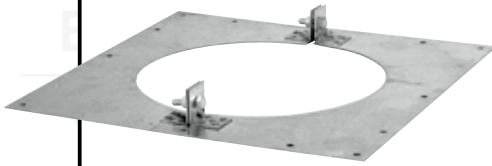

CAT. NO.	SIZE	A	B
10MHS	10"	16"	10.625"
12MHS	12"	18"	12.625"
14MHS	14"	20"	14.625"
16MHS	16"	22"	16.625"
18MHS	18"	24"	18.625"
20MHS	20"	26"	20.625"
22MHS	22"	28"	22.625"
24MHS	24"	30"	24.625"
26MHS	26"	32"	26.625"
28MHS	28"	34"	28.625"
30MHS	30"	36"	30.625"

Designed to support large size pipe sections.
Also serves as a firestop.

GUY RING – MGR

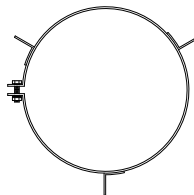

Sizes 10" through 30"
For additional support above the roof.

TYPE - B GAS VENT - ROUND FITTINGS

STANDARD FLASHING – MF

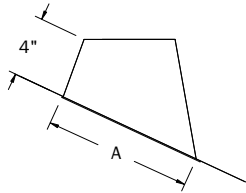
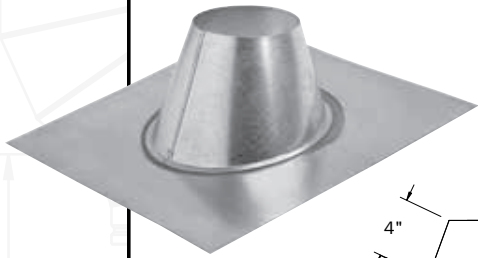

CAT. NO.	SIZE	A	PLATE	CAT. NO.	SIZE	A	PLATE
3MF	3"	7.500"	14.625" x 14.625"	16MF	16"	21.000"	29" x 29"
4MF	4"	7.500"	14.625" x 14.625"	18MF	18"	22.750"	32" x 32"
5MF	5"	8.250"	14.625" x 14.625"	20MF	20"	27.000"	33" x 33"
6MF	6"	9.500"	17.500" x 17.500"	22MF	22"	26.750"	35" x 35"
7MF	7"	11.000"	19.000" x 19.000"	24MF	24"	29.250"	38" x 38"
8MF	8"	12.000"	20.000" x 20.000"	26MF	26"	31.750"	40" x 40"
10MF	10"	14.625"	22.375" x 22.375"	28MF	28"	32.750"	42" x 42"
12MF	12"	16.625"	24.000" x 24.000"	30MF	30"	36.250"	45" x 45"
14MF	14"	18.750"	26.750" x 26.750"				

Fits roof pitch from 2/12 to 5/12

12/12 FLASHING – MF - 12

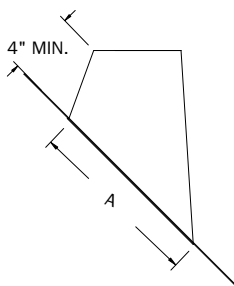

CAT. NO.	SIZE	A	PLATE
3MF-12	3"	12.000"	20" x 20"
4MF-12	4"	12.000"	20" x 20"
5MF-12	5"	12.000"	20" x 20"
6MF-12	6"	12.500"	21" x 28"
7MF-12	7"	13.000" x 18.000" Oval	21" x 28"
8MF-12	8"	13.000" x 18.000" Oval	21" x 28"

Fits roof pitch 6/12 to 12/12

TALL CONE FLAT FLASHING – MFT

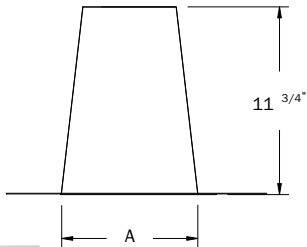
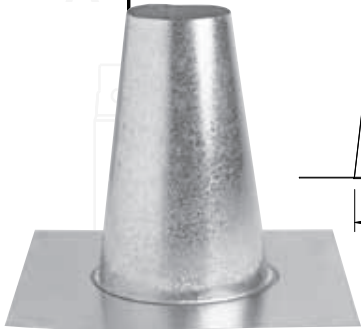

CAT. NO.	SIZE	A	PLATE	CAT. NO.	SIZE	A	PLATE
3MFT	3"	7.500"	14.625" x 14.625"	16MFT	16"	21.312"	29" x 29"
4MFT	4"	7.500"	14.625" x 14.625"	18MFT	18"	22.562"	32" x 32"
5MFT	5"	8.250"	14.625" x 14.625"	20MFT	20"	24.750"	33" x 33"
6MFT	6"	9.500"	17.500" x 17.500"	22MFT	22"	26.750"	35" x 35"
7MFT	7"	11.000"	19.000" x 19.000"	24MFT	24"	28.750"	38" x 38"
8MFT	8"	12.000"	20.000" x 20.000"	26MFT	26"	30.750"	40" x 40"
10MFT	10"	14.562"	22.375" x 22.375"	28MFT	28"	33.875"	42" x 42"
12MFT	12"	16.625"	24.000" x 24.000"	30MFT	30"	34.750"	45" x 45"
14MFT	14"	19.000"	26.750" x 26.750"				

Flat roof flashing.

TYPE - B GAS VENT - ROUND FITTINGS

VENT COLLAR – MVC - 3" through 8"

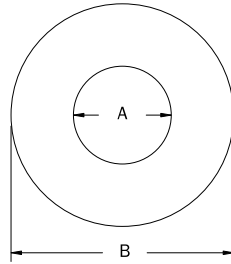

CAT. NO.	SIZE	A	B
3MVC	3"	3.5625"	8.250"
4MVC	4"	4.5625"	8.750"
5MVC	5"	5.5625"	10.125"
6MVC	6"	6.5625"	10.125"
7MVC	7"	8.0000"	13.875"
8MVC	8"	9.0000"	13.875"

STORM COLLAR – MSC

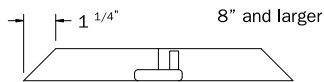
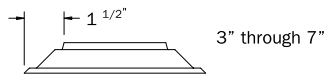

CAT. NO.	SIZE	CAT. NO.	SIZE
3MSC	3"	16MSC	16"
4MSC	4"	18MSC	18"
5MSC	5"	20MSC	20"
6MSC	6"	22MSC	22"
7MSC	7"	24MSC	24"
8MSC	8"	26MSC	26"
10MSC	10"	28MSC	28"
12MSC	12"	30MSC	30"
14MSC	14"		

STORM COLLAR SEALANT TAPE – MST



WATERPROOF - Will not harden or oxidize from weather.

NON TOXIC

Dimensions are 1/16" in thickness by 5/8" width, 25 feet to the roll.

TYPE - B GAS VENT - OVAL PIPE & FITTINGS

OVAL PIPE – MO - 4" through 6"

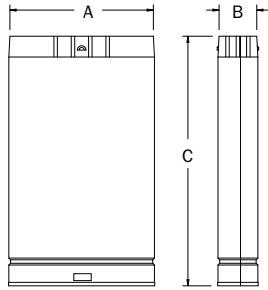
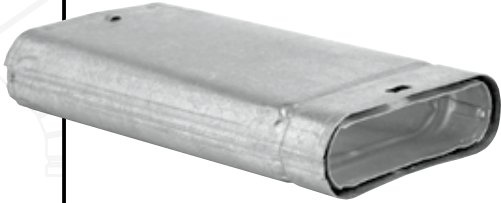

CAT. NO.	SIZE	A	B	C LENGTHS
4MO	4"	7.25"	2.500"	6", 12", 18", 2', 3', 4', 5'
5MO	5"	10.50"	2.875"	6", 12", 18", 2', 3', 4', 5'
6MO	6"	12.00"	3.250"	6", 12", 18", 2', 3', 4', 5'

4" & 5" oval fit 2" x 4" or 2" x 6" stud walls.
6" oval fits 2" x 6" stud wall.

OVAL ADJUSTABLE LENGTH – M012A

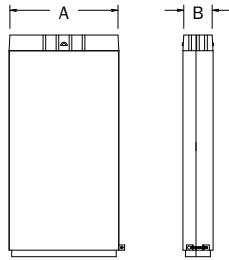
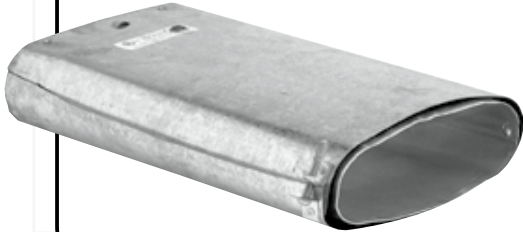

CAT. NO.	SIZE	LISTED LENGTH
4M012A	4"	12"
5M012A	5"	12"
6M012A	6"	12"

M012A adjusts from 3" to 9".

45° STANDARD FIXED ANGLE – M045S

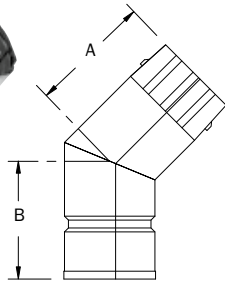
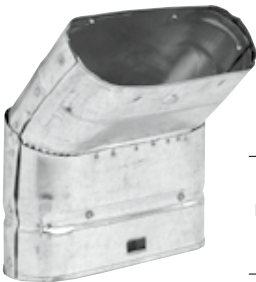

CAT. NO.	SIZE	A	B	OFFSET
4M045S	4"	2.25"	3.75"	4.50"
5M045S	5"	2.25"	3.75"	4.50"
6M045S	6"	2.25"	3.75"	4.50"

45° FLAT FIXED ANGLE – M045F

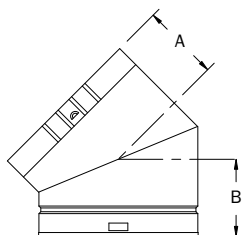

CAT. NO.	SIZE	A	B	OFFSET
4M045F	4"	3.000"	4.750"	5.5"
5M045F	5"	3.375"	4.875"	3.5"
6M045F	6"	4.250"	5.500"	3.0"

TYPE - B GAS VENT - OVAL PIPE & FITTINGS

ADAPTER: ROUND TO OVAL – MRO

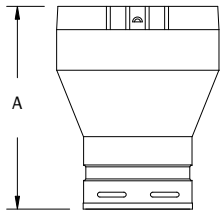

CAT. NO.	OVAL SIZE	ROUND SIZE	A	CAT. NO.
4MRO	4"	4"	8.75"	4MOR
5MRO	5"	5"	10.50"	5MOR
6MRO	6"	6"	11.50"	6MOR
6MRO5	6"	5"	11.50"	6MOR5

ADAPTER: OVAL TO ROUND – MOR

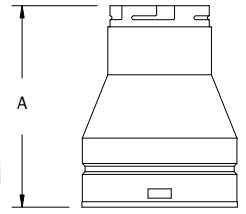

OVAL TEE – MOT

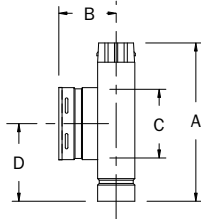

CAT. NO.	A	B	C	D
4MOT	11"	4.50"	4"	6.25"
4MOT3	11"	4.50"	3"	6.25"
5MOT	11"	4.75"	5"	6.25"
6MOT	11"	5.00"	6"	6.25"

OVAL VENT CAP – MOC

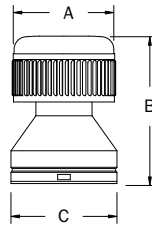

CAT. NO.	SIZE	A	B	C
4MOC	4"	8.25"	11.5625"	7.5"
5MOC	5"	10.00"	14.6250"	10.5"
6MOC	6"	12.00"	16.0000"	12.0"

OVAL ADJUSTABLE ROOF FLASHING – MOF

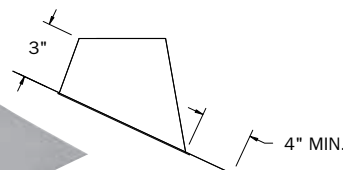
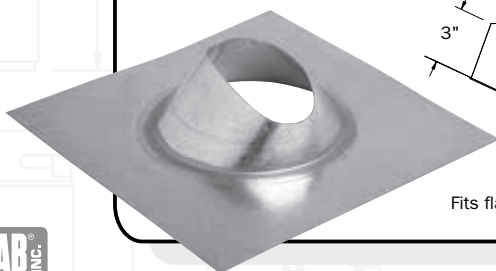

Fits flat to 5/12 roof pitch.

CAT. NO.	SIZE
4MOF	4"
5MOF	5"
6MOF	6"

TYPE - B GAS VENT - OVAL PIPE & FITTINGS

OVAL STORM COLLAR – MOSC

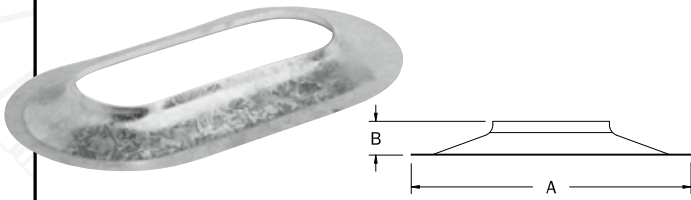

CAT. NO.	SIZES	A	B
4MOSC	4"	10.875"	0.75"
5MOSC	5"	13.500"	1.50"
6MOSC	6"	15.125"	1.50"

OVAL TEE CAP – MOTC



CAT. NO.
4MOTC
5MOTC
6MOTC

Sizes 4" through 6"
Use to cap flue when tee has no bottom (inlet) entry.

OVAL TEE SUPPORT – MOTS

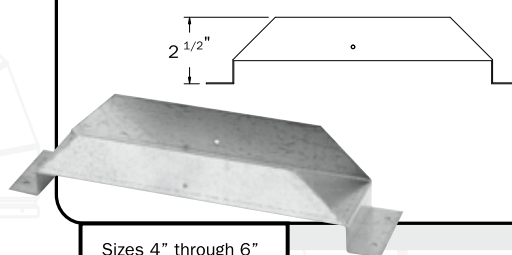

CAT. NO.
4MOTS
5MOTS
6MOTS

Sizes 4" through 6"

OVAL FIRESTOP SPACERS – MOFS, MOFS6

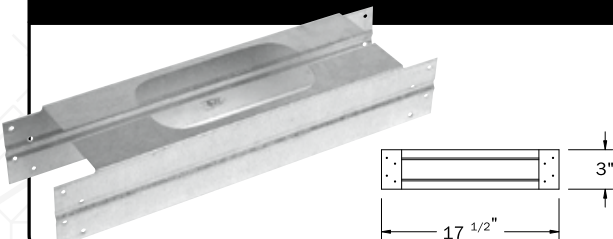

CAT. NO.	CAT. NO.
4MOFS	4MOFS6
5MOFS	5MOFS6
6MOFS	

Sizes 4" through 6"
Fits space between studs 16" on center.
Note: Model MOFS6 is for 2" x 6" stud wall.

BW INSTALLATION KIT – MOK - 4" ONLY

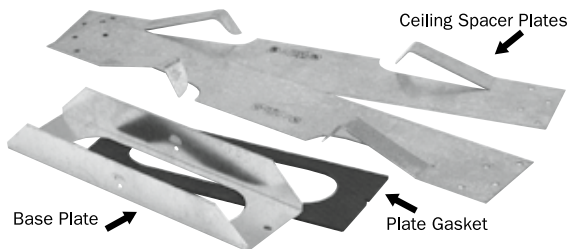

CAT. NO.
4MOK

Kit Includes:
4CPS Ceiling Spacer Plates (2)
4BP Base Plate (1)
Gasket (1)

For venting recessed wall heaters. The installation kit adapts 4" MO pipe for use with wall furnaces.

METAL-FAB[®] INC.

P.O. BOX 1138 • WICHITA, KANSAS 67201

(316) 943-2351 • FAX (316) 771-4154

e-mail: info@metal-fabinc.com • www.metal-fabinc.com

800-835-2830