

CORR/GUARD®

INTRODUCING
NEW MODEL CGV

SPECIAL GAS VENT

PRECISION ENGINEERED FOR FAST INSTALLATION

EXCLUSIVE SNAP-LOCK DESIGN

SINGLE WALL
DOUBLE WALL
3", 4" & 5" DIAMETER



MODEL CG - STANDARD • MODEL CGV - VALUE

CORR/GUARD® FEATURE BENEFITS

**Corr/Guard® makes your job easier with exclusive benefits...
the Gold Standard of Special Gas Vent!**

FAST, EASY INSTALLATION

One-step connection and snap lock - just slide together until it "clicks" tight, no tools required.
Moderate insertion force needed.
Fewer supports required on horizontal runs.

QUICK AVAILABILITY

Ships in as little as 2-3 days.
100% order fill.

NO SAGGING

Tight overlap and lock prevent sag and "wobble".
Fewer supports needed.

LEAKPROOF GOLD SEAL

Seamless, precision formed "gold seal" gasket.
Close tolerance pipe.
Snap lock.

PRECISION ENGINEERED GOLD QUALITY

Gasket is molded to fit, not extruded/spliced.
Continuous weld inside the flue on elbows, not taped.
TIG welded pipe.
Consistently close tolerances.
Pressure rated to 10 inches of water column.
AL29-4C® or 550° superferritic stainless steel.
UL Listed - tested and labeled to UL1738 for Category II, III & IV appliances.
Limited Lifetime Warranty.
Patent Pending.

FULL LINE

3", 4", 5" diameter, 6" - 48" lengths. (For 6" - 36" dia. refer to L2610 design manual.)
Complete selection of components.

MULTIPLE APPLICATIONS

Single Wall Special Vent Pipe
Double Wall Special Vent Pipe
Double Wall can also be used for Direct Vent applications.

Specify the model that fits your application:

CG - Standard: AL29-4C stainless steel,
limited lifetime warranty.

See price list L1758.

Example:

Single Wall Straight Length = CGSW

CGV - Value: Superferritic stainless steel,
five year warranty.

See price list L1758.

Example:

Single Wall Straight Length = CGVSW

One-step connection...fastest on the market!

*Just push together until the snap-lock tabs "click" into locked position,
your assurance of a leak-free connection.*



AL29-4C® is a registered trademark of ATI Properties, Inc.

CORR/GUARD PRODUCT INFORMATION

APPLICATION INFORMATION	DOUBLE WALL	SINGLE WALL
Maximum Operating Temp.	550 Degrees F (288 C)	550 Degrees F (288 C)
Maximum Operating Pressure	10" w.g.	10" w.g.
Clearance to Combustibles HORIZONTAL-Enclosed	3", 4" & 5" Diameters 300 F (149 C) =3" (76 mm) 480 F (249 C) =6" (153 mm) 550 F (288 C) =Do Not Enclose	3" & 4" Diameters 480 F (249 C) =8" (203 mm) 550 F (288 C) =Do Not Enclose Do Not Enclose 5" Diameter
Clearance to Combustibles HORIZONTAL-Unenclosed	3", 4" & 5" Diameters 550 F (288 C) =1" (25 mm)	3", 4" & 5" Diameters 400 F (204 C) =1" (25 mm) 550 F (288 C) =2" (51mm)
Clearance to Combustibles VERTICAL-Enclosed	3", 4" & 5" Diameters 480 F (249 C) =6" (153 mm) 550 F (288 C) =Do Not Enclose	3" & 4" Diameters 480 F (249 C) =4" (102 mm) 550 F (288 C) =Do Not Enclose 5" Diameter 480 F (288 C) =6" (152mm) 550 F (288 C) =Do Not Enclose
Clearance to Combustibles VERTICAL-Unenclosed	3", 4" & 5" Diameters 550 F (288 C) =1" (25 mm)	3", 4" & 5" Diameters 400 F (204 C) =1" (25 mm) 550 F (288 C) =2" (51 mm)
Joint Connection	Gasketed; No Sealant Required	Gasketed; No Sealant Required
Flue Material & Thickness	AL29-4C (0.015) 444 (0.015)	AL29-4C (0.015) 444 (0.015)
Casing Material & Thickness	Aluminized Steel (0.018) Optional 430 Stainless Steel (0.018) Optional 304 Stainless Steel (0.018) Optional 316 Stainless Steel (0.018)	Not Applicable Not Applicable Not Applicable Not Applicable

CODES AND STANDARDS



MH26687

Corr/Guard is listed to UL 1738, Standard for Venting Systems for Gas-Burning Appliances, Categories II, III, and IV. These requirements cover venting systems intended for venting Category II, III, and IV gas-burning appliances as defined by the Standard for Gas-Fired Central Furnaces (except Direct Vent Central Furnaces), ANSI Z21.47 and the National Fuel Gas Code, NFPA 54. Venting systems covered by these requirements are intended to be used with Category II, III, and IV appliances that have been installed in accordance with NFPA 54, and with codes such as the BOCA National Mechanical Code, the Standard Mechanical Code, the Uniform Mechanical Code, and local codes.

Corr/Guard vent material is AL29-4C® or superferritic stainless steel. This vent is intended for use wherever appliance manufacturers specify superferritic stainless steel as the required vent material and, vent gas temperatures do not exceed those listed in the Metal-Fab Installation Instructions and the Application section of this manual.

New York City, NY MEA Approval No. 78-00-E

For complete details on Corr/Guard 6"-36" diameter vent, please see the Corr/Guard II Design Manual, Form No. L2610

SINGLE WALL CORR/GUARD APPLICATION DRAWINGS

ROOF EXHAUST

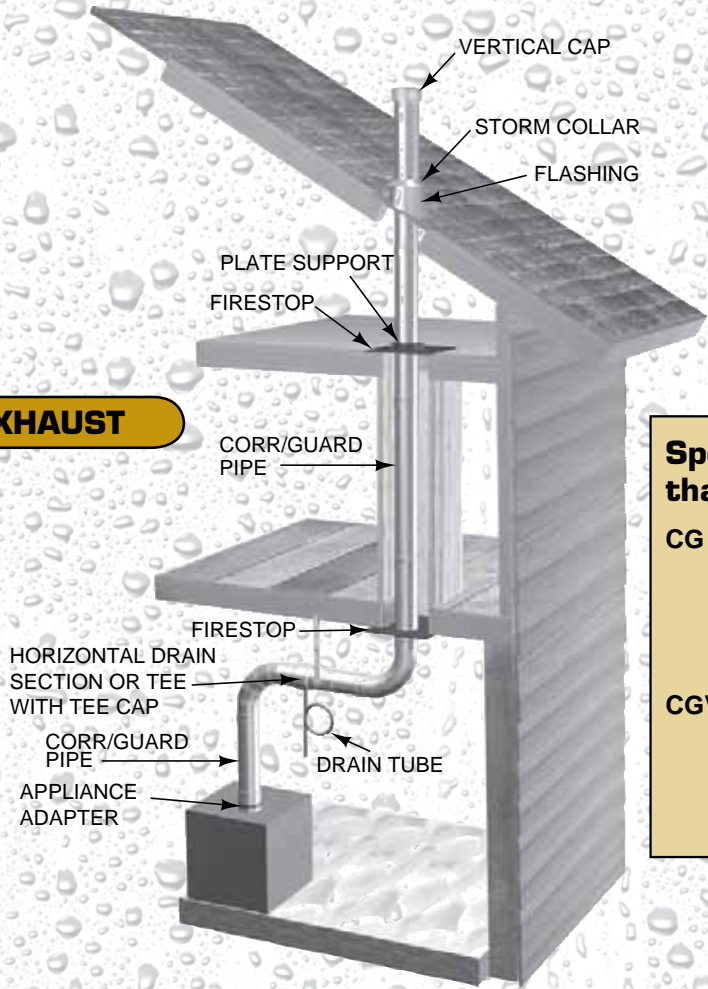

Specify the model that fits your application:

CG - Standard: AL29-4C stainless steel, limited lifetime warranty. See price list L1758.
 Example: Single Wall Straight Length = CGSW

CGV - Value: Superferritic stainless steel, five year warranty. See price list L1758.
 Example: Single Wall Straight Length = CGVSW

SIDEWALL EXHAUST

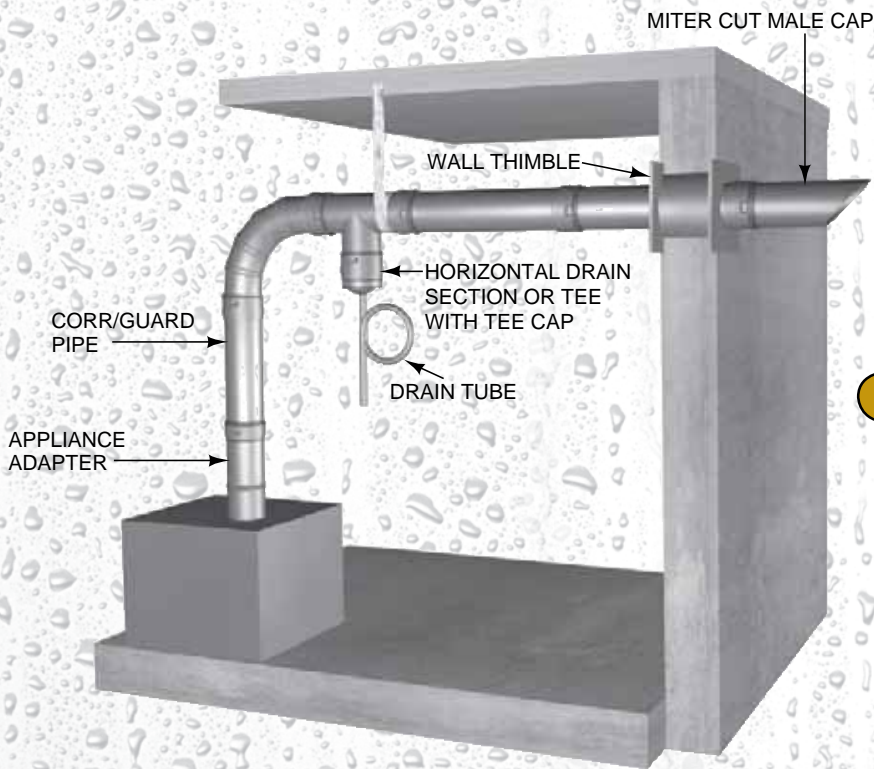

SINGLE WALL CORR/GUARD

NOTE: Corr/Guard pipe overlaps 2.25" when joined together, therefore assembled length is 2.25" less than listed length.

STRAIGHT LENGTH - CGSW

I.D.	C
3.00	5.66
3.00	11.66
3.00	17.66
3.00	23.66
3.00	35.66
3.00	47.66
4.00	5.66
4.00	11.66
4.00	17.66
4.00	23.66
4.00	35.66
4.00	47.66
5.00	5.66
5.00	11.66
5.00	17.66
5.00	23.66
5.00	35.66
5.00	47.66

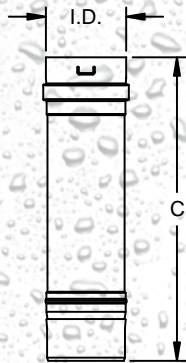

STRAIGHT LENGTH W/SCREEN

CGSWHTM (MALE)



I.D.
3.00
4.00
5.00

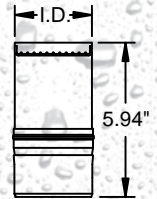

CGSWHTF (FEMALE)

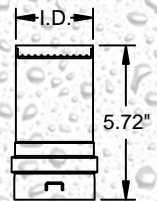

VARIABLE LENGTH

CGSWVL (VL10)

CGSWVL (VL22)

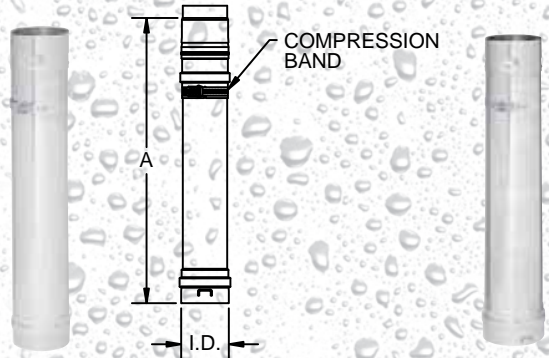

VL10

I.D.	A
3.00	7.50 TO 10.00
4.00	7.50 TO 10.00
5.00	7.50 TO 10.00

VL22

3.00	7.50 TO 22.00
4.00	7.50 TO 22.00
5.00	7.50 TO 22.00

MALE TO MALE ADAPTER - CGSWDMA

I.D.
3.00
4.00
5.00

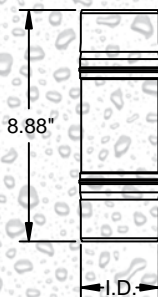

FEMALE TO FEMALE ADAPTER - CGSWDFA

I.D.
3.00
4.00
5.00

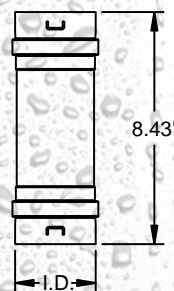

SINGLE WALL CORR/GUARD

NOTE: Be sure to specify the model that fits your specification, prefix CG or CGV.

90° ELBOW - CGSW90L; CGSW90SL

	A	B	C	D
3CGSW90L	8.13	8.00	16.13	13.94
4CGSW90L	8.13	8.00	16.13	13.94
5CGSW90L	8.13	8.00	16.13	13.94
3CGSW90SL	5.56	5.56	11.13	8.88
4CGSW90SL	5.56	5.56	11.13	8.88

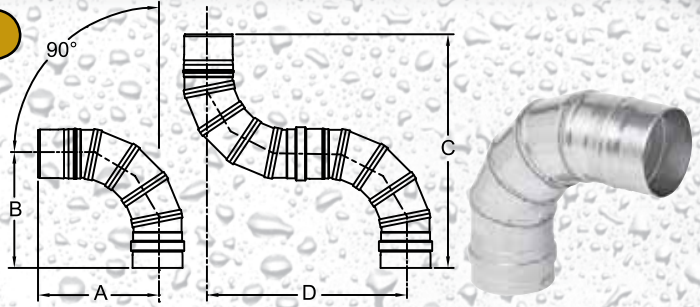

90° ELBOW W/SCREEN

CGSW90LTF (FEMALE)

CGSW90LTM (MALE)

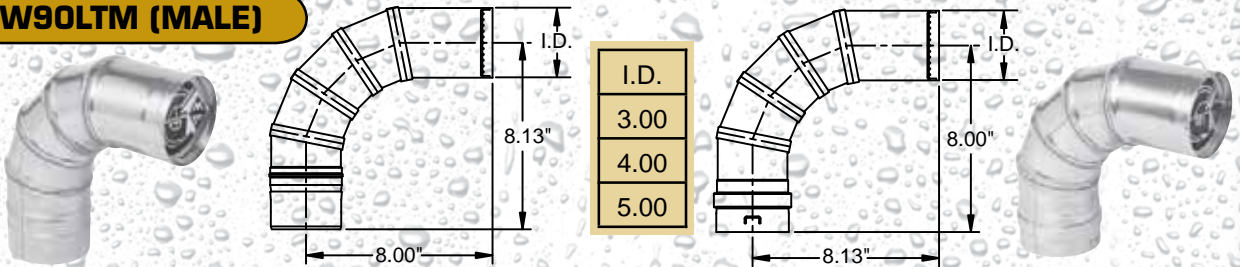

45° ELBOW - CGSW45L

I.D.
3.00
4.00
5.00

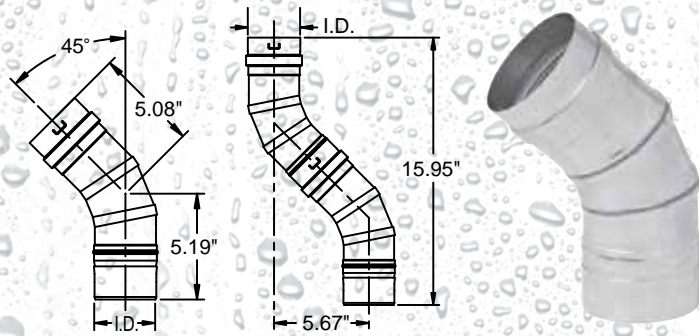

90° TEE - CGSWT

I.D.	A
3.00	10.00
4.00	11.00
5.00	12.00

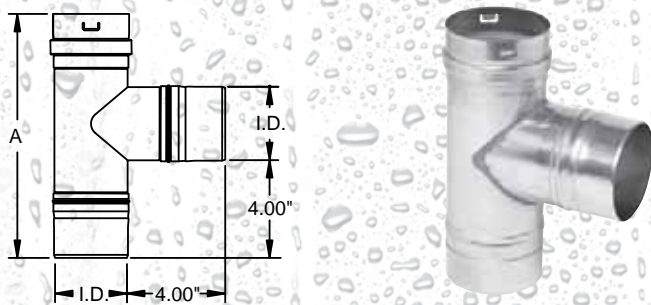

TEE W/SCREEN

CGSWTTF (FEMALE)

CGSWTTM (MALE)

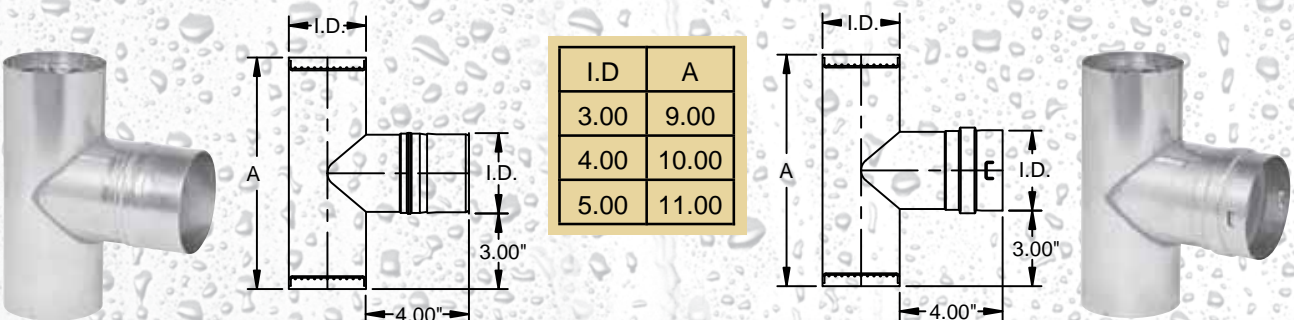

SINGLE WALL CORR/GUARD

NOTE: Corr/Guard pipe overlaps 2.25" when joined together, therefore assembled length is 2.25" less than listed length.

TEE CAP

W/O DRAIN FITTING - CGSWTCN

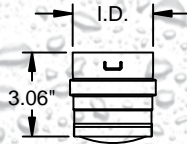

I.D.
3.00
4.00
5.00

W/ DRAIN FITTING - CGSWTC

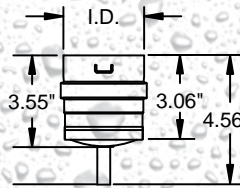

BOOT TEE - CGSWBT

I.D.	O.D.	A
3.00	5.00	11.50
4.00	6.00	12.50
5.00	7.00	13.50

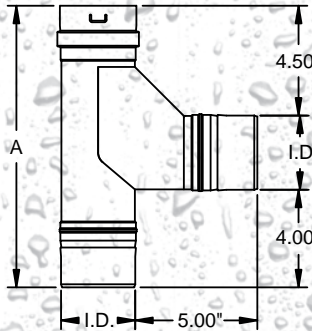

HORIZONTAL DRAIN SECTION - CGSWDS

I.D.
3.00
4.00
5.00

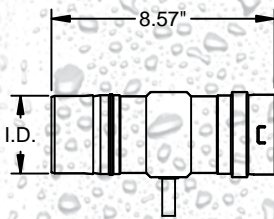

VERTICAL CAP - CGSWC

I.D.	A
3.00	8.25
4.00	8.25
5.00	10.00

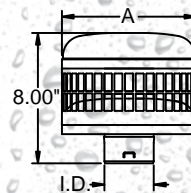

MITER CUT CAP

CGSWMCM - (MALE)

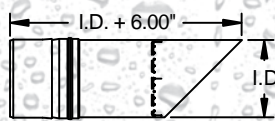

I.D.
3.00
4.00
5.00

CGSWMCF - (FEMALE)

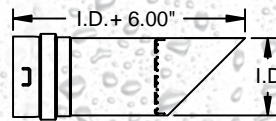

ECCENTRIC REDUCER - CGSWER

B	A
3.00	4.00
4.00	5.00

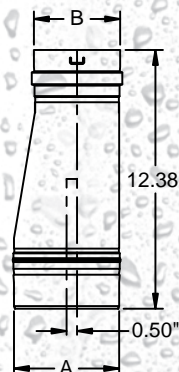

SINGLE WALL CORR/GUARD

NOTE: Corr/Guard pipe overlaps 2.25" when joined together, therefore assembled length is 2.25" less than listed length.

ECCENTRIC INCREASER

TO 4" & 5" DIA. - CGSWEI

A	B	C
3.00	4.00	0.50
4.00	5.00	1.00
5.00	5.00	0.50



TO 6" DIA. - CGSWEI6

A	B
3.00	1.50
4.00	1.00
5.00	0.50

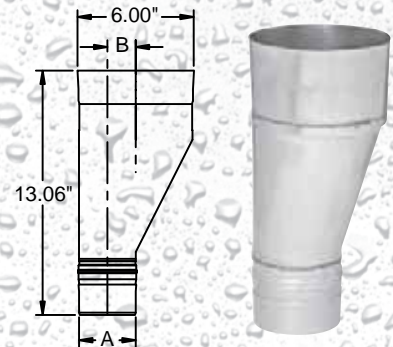

WALL THIMBLE - CGSWWPK

Adjusts from 4.5" to 7.5" wall thickness

A	B	C
3.16	12.00	4.50 TO 7.50
4.16	13.00	4.50 TO 7.50
5.16	14.00	4.50 TO 7.50

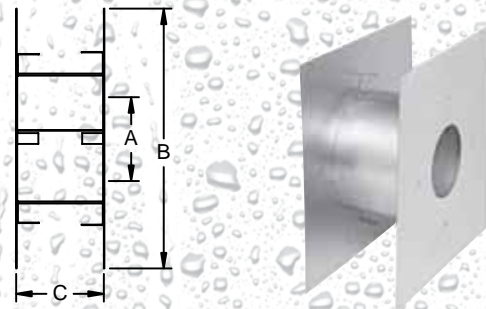

WALL SUPPORT - CGSWWS

I.D.	A	B
3.00	3.38	4.12
4.00	3.88	5.12
5.00	4.38	6.12

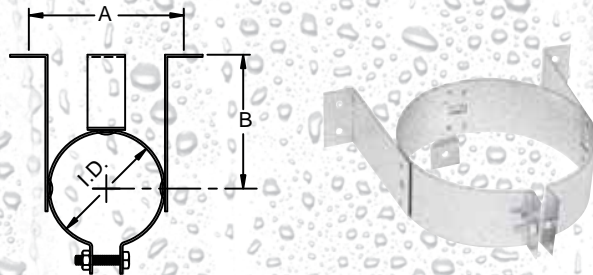

WALL HANGER - CGSWWH

I.D.	A	B
3.00	4.10	3.50
4.00	5.10	4.00
5.00	6.10	4.50

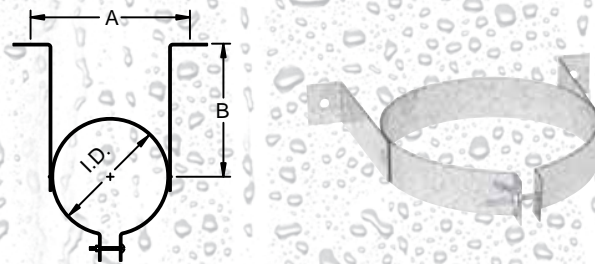
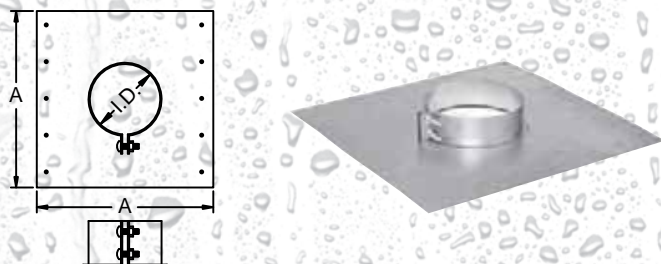

PLATE SUPPORT - CGSWPS

I.D.	A
3.00	17.00
4.00	17.00
5.00	25.00



SINGLE WALL CORR/GUARD

NOTE: Be sure to specify the model that fits your specification, prefix CG or CGV.

GUY RING - CGSWGR

I.D.
3.00
4.00
5.00

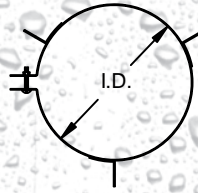

TALL CONE FLASHING - CGSWFT

A	B
3.50	14.63
4.50	14.63
5.50	19.63

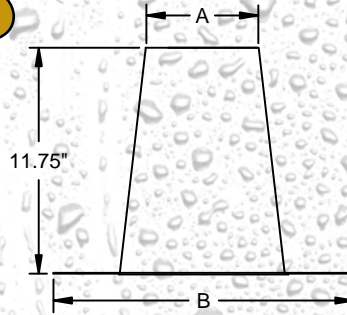

6/12 TO 12/12 PITCH FLASHING - CGSWF-12

A	B
3.50	20 x 20
4.50	21 x 28
5.50	21 x 28

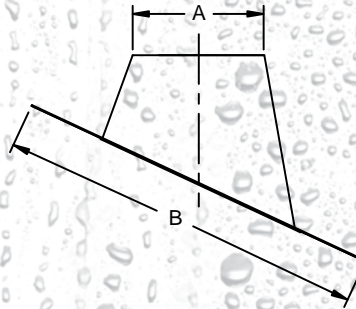

2/12 TO 5/12 PITCH FLASHING - CGSWF

A	B
3.50	14.63
4.50	14.63
5.50	19.63

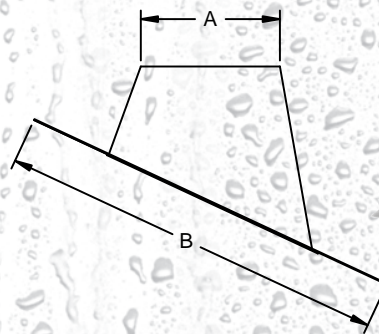

STORM COLLAR - CGSWSC

I.D.
3.00
4.00
5.00

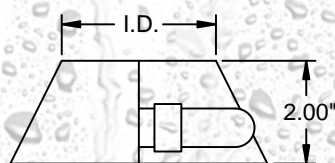

DOUBLE WALL CORR/GUARD APPLICATION DRAWINGS

ROOF EXHAUST

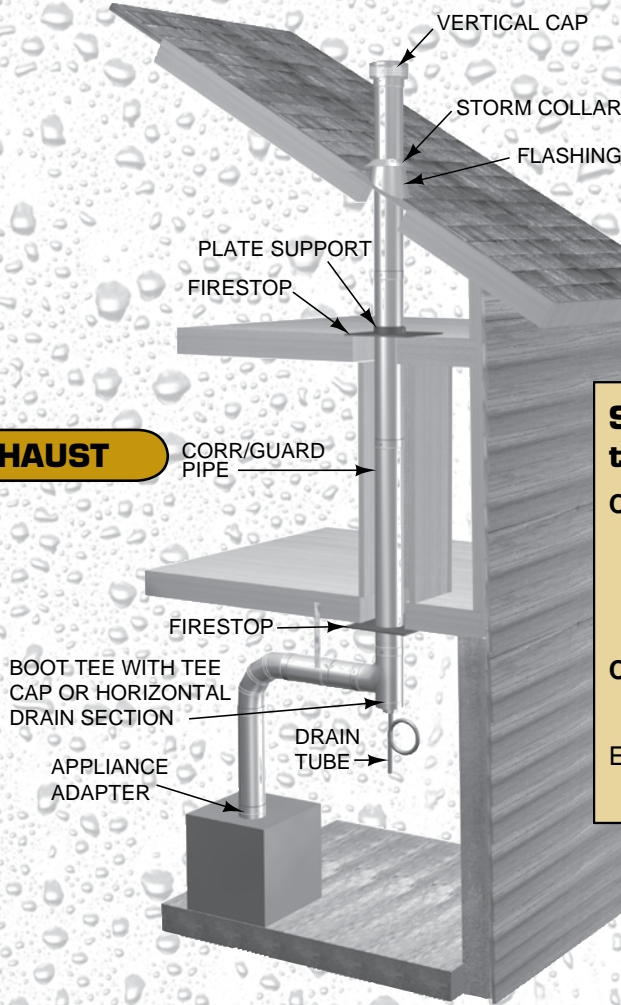

Specify the model that fits your application:

CG - Standard: AL29-4C stainless steel, limited lifetime warranty.

See price list L1758.

Example:

Single Wall Straight Length = CGSW

CGV - Value: Superferritic stainless steel, five year warranty.

See price list L1758.

Example:

Single Wall Straight Length = CGVSW

MITER CUT MALE CAP

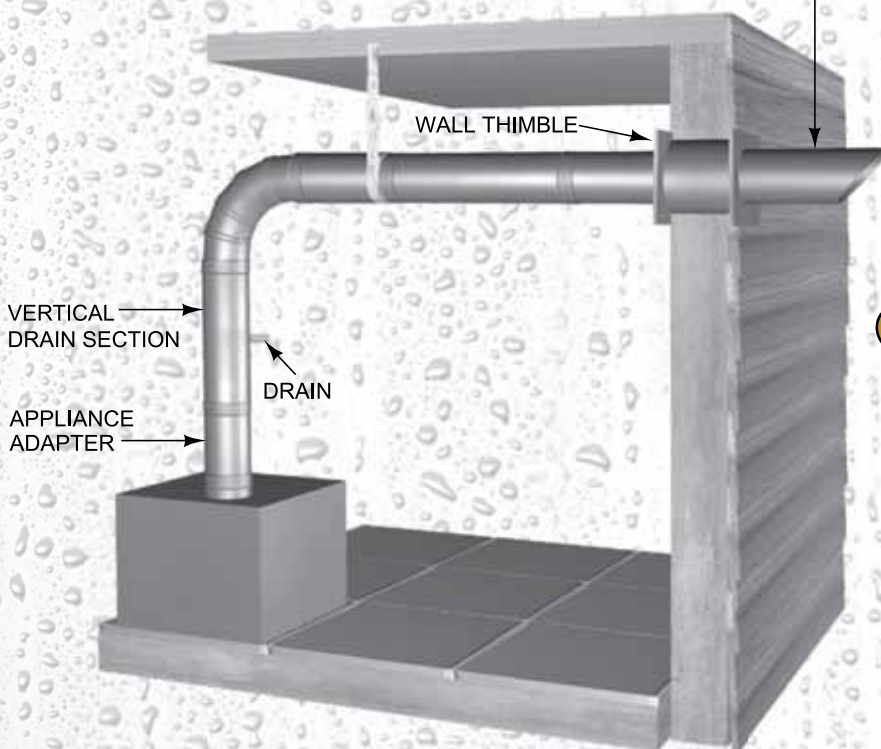

SIDEWALL EXHAUST

DOUBLE WALL CORR/GUARD

NOTE: Corr/Guard pipe overlaps 2.25" when joined together, therefore assembled length is 2.25" less than listed length.

STRAIGHT LENGTH - CG

I.D.	A	B
3.00	5.66	5.00
3.00	11.66	5.00
3.00	17.66	5.00
3.00	23.66	5.00
3.00	35.66	5.00
3.00	47.66	5.00
4.00	5.66	6.00
4.00	11.66	6.00
4.00	17.66	6.00
4.00	23.66	6.00
4.00	35.66	6.00
4.00	47.66	6.00
5.00	5.66	7.00
5.00	11.66	7.00
5.00	17.66	7.00
5.00	23.66	7.00
5.00	35.66	7.00
5.00	47.66	7.00



STRAIGHT LENGTH W/SCREEN

CGHTM (MALE)

I.D.
3.00
4.00
5.00

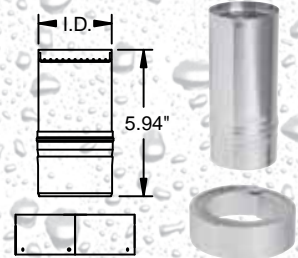

CGHTF (FEMALE)

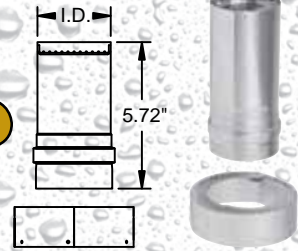

VARIABLE LENGTH

CGVL (VL10)

CGVL (VL22)

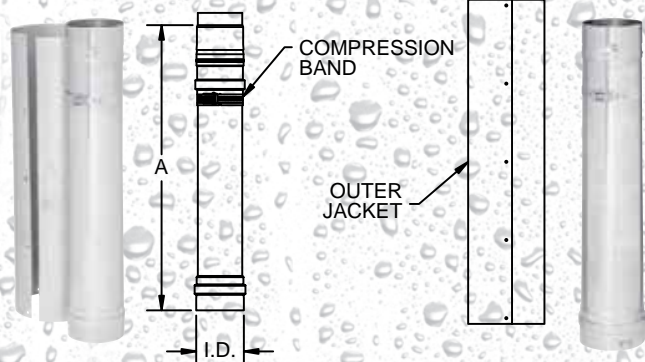

VL10

I.D.	A
3.00	7.50 TO 10.00
4.00	7.50 TO 10.00
5.00	7.50 TO 10.00

VL22

3.00	7.50 TO 22.00
4.00	7.50 TO 22.00
5.00	7.50 TO 22.00

MALE TO MALE ADAPTER - CGDMA

I.D.	A
3.00	5.00
4.00	6.00
5.00	7.00

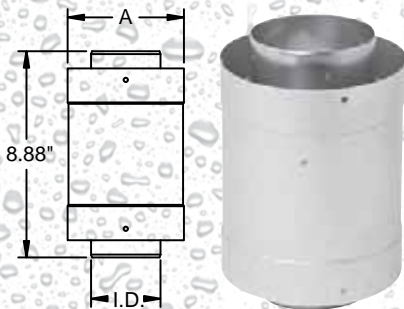

FEMALE TO FEMALE ADAPTER - CGDFA

I.D.	A
3.00	5.00
4.00	6.00
5.00	7.00

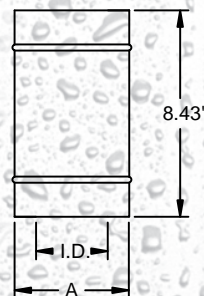

DOUBLE WALL CORR/GUARD

NOTE: Corr/Guard pipe overlaps 2.25" when joined together, therefore assembled length is 2.25" less than listed length.

90° ELBOW - CG90L

I.D.
3.00
4.00
5.00

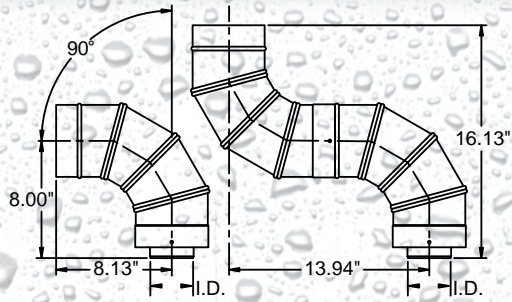

90° ELBOW W/SCREEN

CG90LTM (MALE)

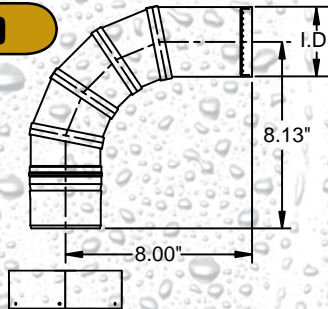

I.D.
3.00
4.00
5.00

CG90LTF (FEMALE)

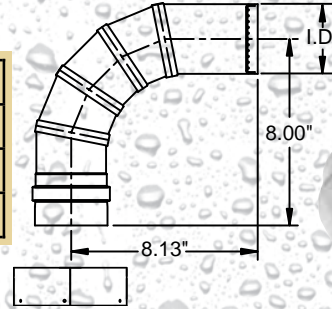

45° ELBOW - CG45L

I.D.
3.00
4.00
5.00

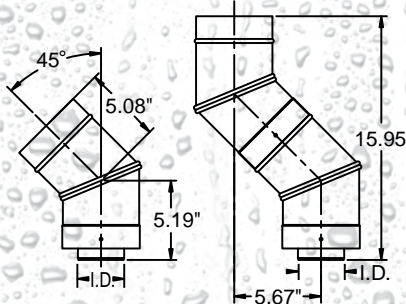

90° TEE - CGT

I.D.	O.D.	A	B
3.00	5.00	10.00	9.25
4.00	6.00	11.00	10.25
5.00	7.00	12.00	11.25

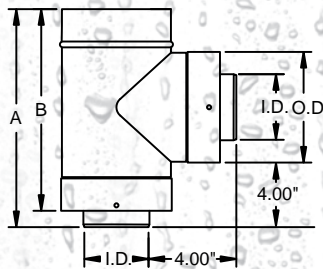

TEE W/SCREEN

CGTTM (MALE)

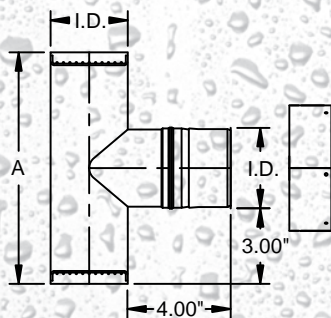

I.D.	A
3.00	9.00
4.00	10.00
5.00	11.00

CGTTF (FEMALE)

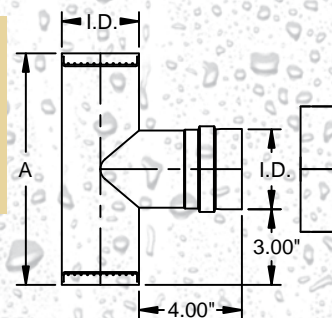

DOUBLE WALL CORR/GUARD

NOTE: Be sure to specify the model that fits your specification, prefix CG or CGV.

TEE CAP

W/O DRAIN FITTING - CGTCN

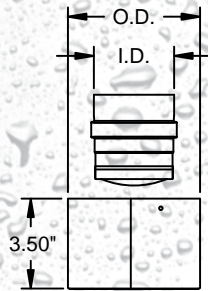

I.D.	O.D.
3.00	5.00
4.00	6.00
5.00	7.00

W/ DRAIN FITTING - CGTC

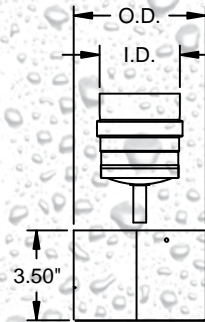

BOOT TEE - CGBT

I.D.	O.D.	A
3.00	5.00	11.50
4.00	6.00	12.50
5.00	7.00	13.50

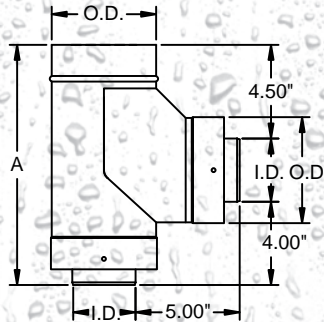

HORIZONTAL DRAIN SECTION - CGDS

I.D.
3.00
4.00
5.00

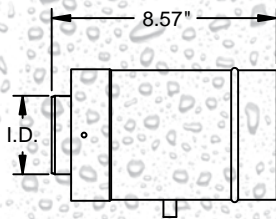

VERTICAL CAP - CGC

I.D.	A
3.00	8.25
4.00	8.25
5.00	10.00

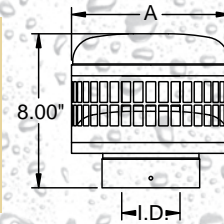

MITER CAP

MALE CAP - CGMCM

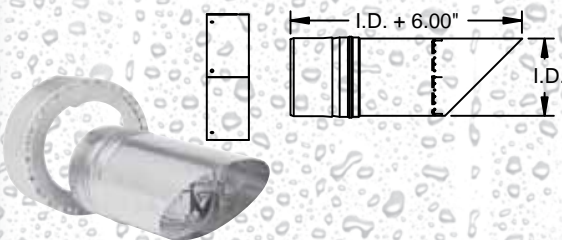

I.D.
3.00
4.00
5.00

FEMALE CAP - CGMCF

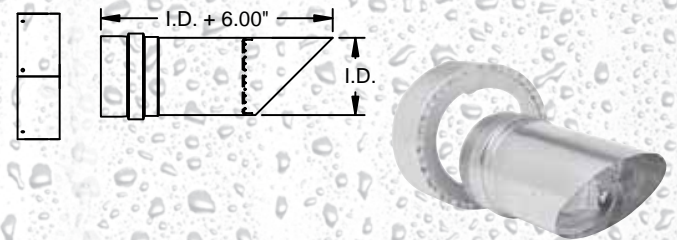

ECCENTRIC REDUCER - CGER

B	A
3.00	4.00
4.00	5.00

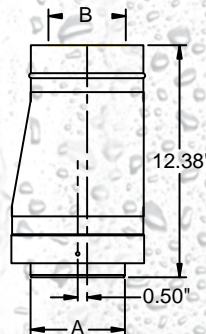

DOUBLE WALL CORR/GUARD

NOTE: Be sure to specify the model that fits your specification, prefix CG or CGV.

ECCENTRIC INCREASER

TO 4" & 5" DIA. - CGEI

A	B	C
3.00	4.00	0.50
3.00	5.00	1.00
4.00	5.00	0.50

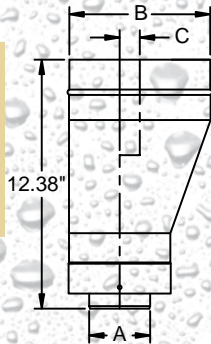

TO 6" DIA. - CGEI6

A	B
3.00	1.50
4.00	1.00
5.00	0.50

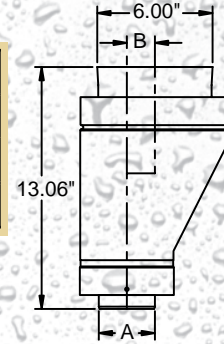

WALL THIMBLE - CGWPK

Adjusts from 4.5" to 7.5" wall thickness

A	B	C
5.16	12.00	4.50 TO 7.50
6.16	13.00	4.50 TO 7.50
7.16	14.00	4.50 TO 7.50

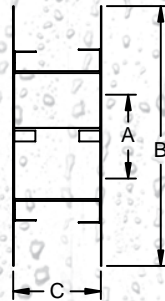

WALL SUPPORT - CGWS

O.D.	A	B
5.00	6.12	3.38
6.00	7.12	3.88
7.00	8.12	4.38

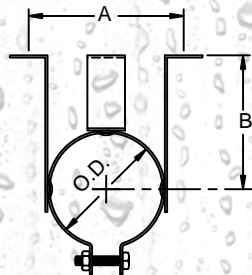

WALL HANGER - CGWH

O.D.	A	B
5.00	6.10	3.50
6.00	7.10	4.00
7.00	8.10	4.50

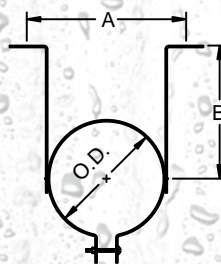
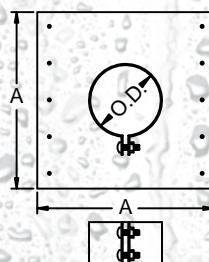

PLATE SUPPORT - CGPS

O.D.	A
5.00	17.00
6.00	17.00
7.00	17.00



DOUBLE WALL CORR/GUARD

NOTE: Corr/Guard pipe overlaps 2.25" when joined together, therefore assembled length is 2.25" less than listed length.

GUY RING - CGGR

O.D.
5.00
6.00
7.00

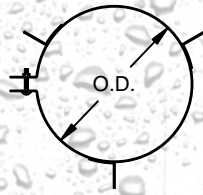

TALL CONE FLASHING - CGFT

A	B
5.50	14.63
6.50	17.50
7.50	19.00

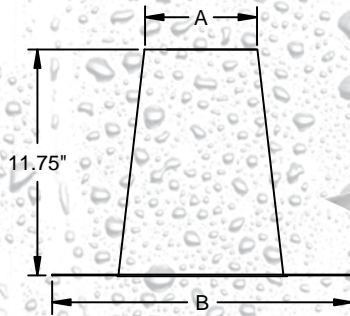

6/12 TO 12/12 PITCH FLASHING - CGF-12

A	B
5.50	20 x 20
6.50	21 x 28
7.50	21 x 28

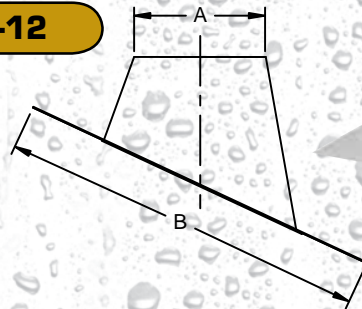

2/12 TO 5/12 PITCH FLASHING - CGF

A	B
5.50	14.63
6.50	17.50
7.50	19.00

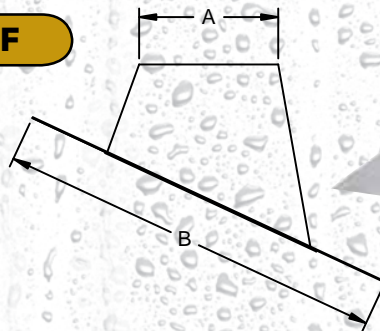

STORM COLLAR - CGSC

O.D.
5.00
6.00
7.00

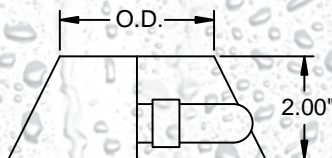

CORR/GUARD KITS

NOTE: Be sure to specify the model that fits your specification, prefix CG or CGV.

HORIZONTAL VENT KIT - 3CGSWHVK 3" AND 4"

NOTE: 4" Kit includes appliance adapter

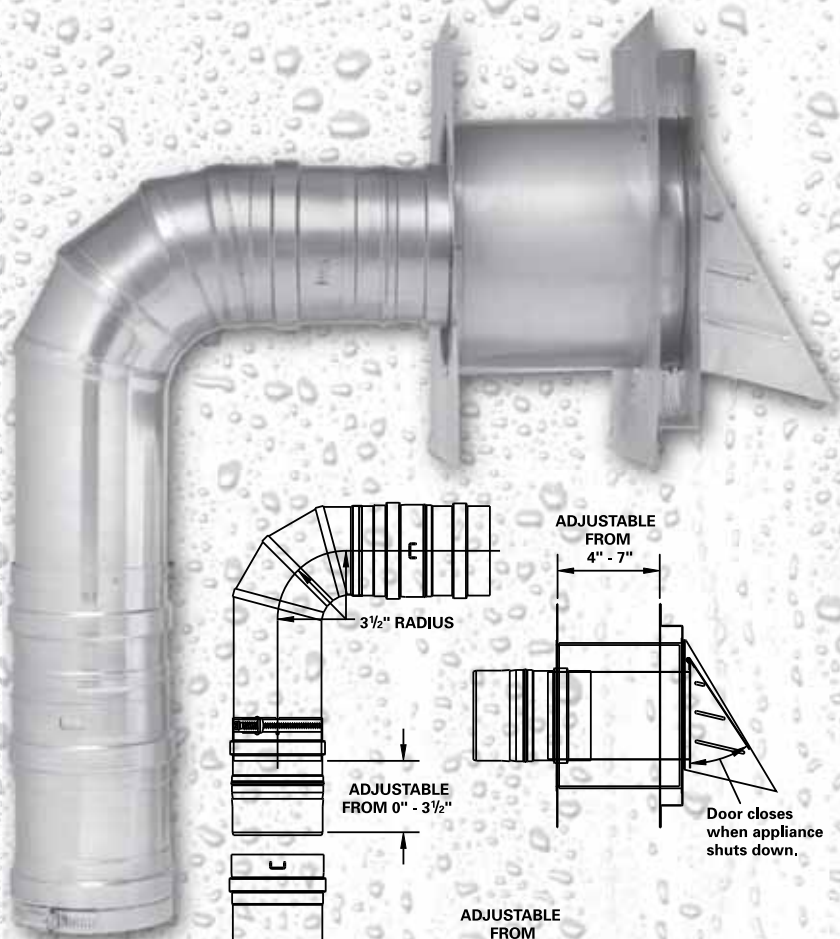

STANDARD VENT DISCHARGE KIT - 3CGRVDK

(Not shown)
Includes 3CGRHA & 3CGRHT*
*Vent pipe added as needed

VERTICAL VENT KIT - 4CGSWVK

Vertical Cap



Storm Collar



Flashing 2/12
through 5/12 pitch



Vertical Drain Section



Double Gasket Appliance Adapter



CORR/GUARD KITS

NOTE: Be sure to specify the model that fits your specification, prefix CG or CGV.

4/7 COAXIAL HORIZONTAL TERMINATION - 4CG7HTL LEFT AND RIGHT ASSEMBLIES - 4CG7HTR

LEFT ASSEMBLY

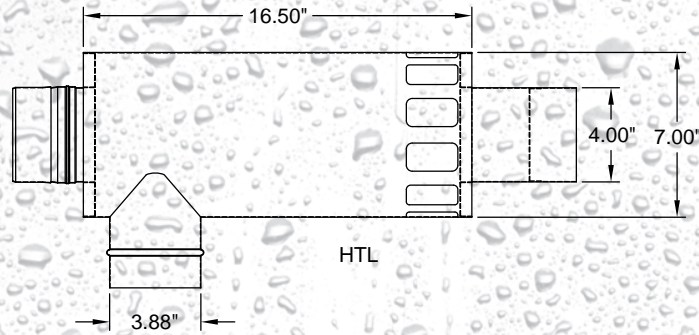

RIGHT ASSEMBLY

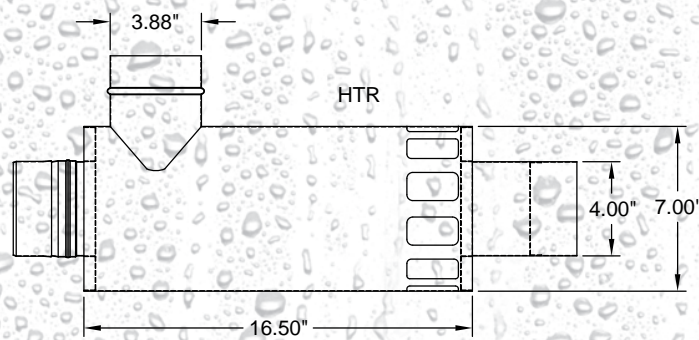

HORIZONTAL TERMINATION ASSEMBLY - 4CG7HT90L LEFT AND RIGHT ASSEMBLIES - 4CG7HT90R

LEFT ASSEMBLY

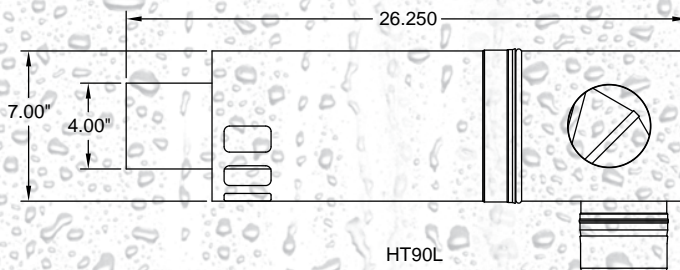

RIGHT ASSEMBLY

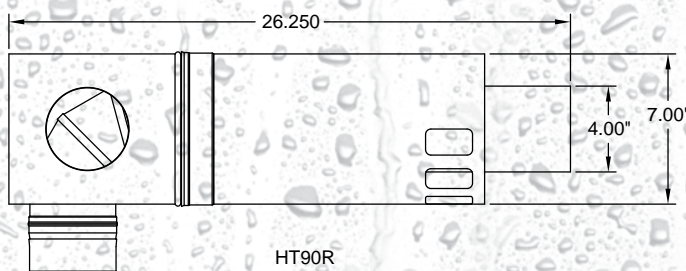

CORR/GUARD SPECIAL APPLICATIONS

NOTE: Be sure to specify the model that fits your specification, prefix CG or CGV.

HORIZONTAL APPLIANCE ADAPTERS - 3CGRLSH

I.D.	O.D.
3.00	5.00

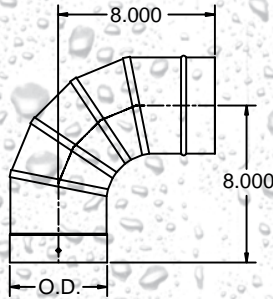

HORIZONTAL TERMINATION - 3CGRHT

I.D.
3.00

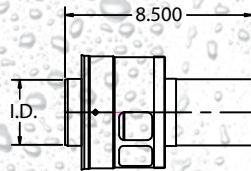

VERTICAL APPLIANCE ADAPTERS - 3CGRLSV - 3CGPA

A	I.D.
5.06	3.00

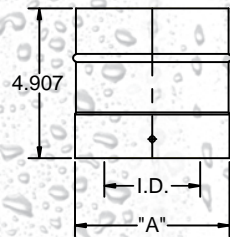

VERTICAL TERMINATION - 3CGRVT

I.D.
3.00

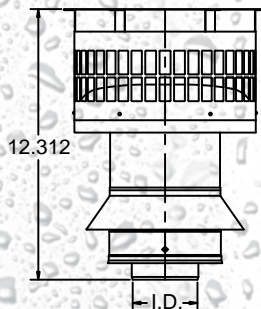

CORR/GUARD COMPARISONS

**How does your Special Gas Vent stack up to Metal-Fab?
Use this handy chart to evaluate your current supplier.**

	Metal-Fab	Heat Fab	ProTech	Z-Flex
1. One-Step Snap Lock	X			
2. Fewest Supports Required	X			
3. No Sag and Wobble	X			
4. Seamless Precision Gasket	X			
5. Continuously Welded Elbows	X			
6. TIG Welded Pipe	X			
7. Consistently Close Tolerances	X			
8. Pressure Rated to 10" W.C.	X			
9. AL29-4C® or Equivalent Stainless	X			
10. Limited Lifetime Warranty	X			
11. Patent Pending	X			
12. Friendly Customer Service	X			
13. Shipping in 2-3 days	X			
14. Regional Warehouses	X			
15. 100% Order Fill	X			
16. E-Mail Order Acknowledgement	X			
17. E-Mail Order Tracking	X			
18. Stretch Wrapped Skids	X			
19. Skid Stickers	X			
20. Skid Lists	X			
21. Convenient Unloading At Your Site	X			
22. Technical Support	X			

A FULL LINE OF QUALITY PRODUCTS

TYPE-B GAS VENT



Easiest installation on the market...featuring SureLock® B-Vent Locking System.

BIGVENT™



Complete line of Type-B Gas Vent in 14" through 30" diameters.

FLEXIBLE CHIMNEY LINERS



Available in complete relining kits.

TEMP/GUARD®



Double-wall chimney for use with listed wood, coal, oil or gas-fired appliances.

BIOMASS CHIMNEY



Tested and UL 641 Listed, 3" and 4" diameters, positive twist lock.

BLACK STOVEPIPE



Single wall and double wall tested to UL 103.

DAMPERS



Complete line of fire and ceiling radiation dampers. Capacity to fill high volume orders 100%.

GRILLES & REGISTERS



A quality, complete line including 2X2 and extruded aluminum.

DIAMONDBACK™



Flexible Gas Piping - Faster installations of gas pipe for new construction or retrofit projects.



P.O. BOX 1138 • WICHITA, KANSAS 67201 • (316) 943-2351 • FAX (316) 771-4154

e-mail: info@metal-fabinc.com • www.metal-fabinc.com

800-835-2830