

### Features

- 36-inch minimum base cabinet width.
- Large/medium bowls.
- 9-inch depth.
- Shortened apron allows sink to be used in most standard cabinetry or retrofitted to existing standard cabinetry.
- Self-Trimming apron overlaps the cabinet face for easy installation and beautiful results.
- No faucet holes.
- Smart Divide® features a low dividing barrier that increases workspace and versatility.
- Basin slopes toward drain to minimize water pooling.
- Offset drain increases workspace in the sink and storage space underneath.

### Material

- KOHLER® enameled cast iron.

### Installation

- Under-mount apron-front.

### Recommended Accessories

K-9000 P-Trap

### Optional Accessories

K-5828 Basin Rack Large  
K-5874 Basin Rack Small  
8801

### Components

Additional included component/s: Countertop cut-out template, and Cabinet face cut-out template.



### Codes/Standards







ASME A112.19.1/CSA B45.2

### Kohler Enameled Cast Iron Kitchen Sink - Lifetime Limited Warranty

See website for detailed warranty information.

### Available Color/Finishes

*Color tiles intended for reference only.*

Color	Code	Description
	0	White
	FF	Sea Salt™
	96	Biscuit
	47	Almond
	FD	Cane Sugar™
	NY	Dune
	95	Ice™ Grey
	G9	Sandbar
	33	Mexican Sand™
	K4	Cashmere
	FT	Basalt
	58	Thunder™ Grey
	20	Suede
	KA	Black 'n Tan
	FP	Caviar
	7	Black Black™

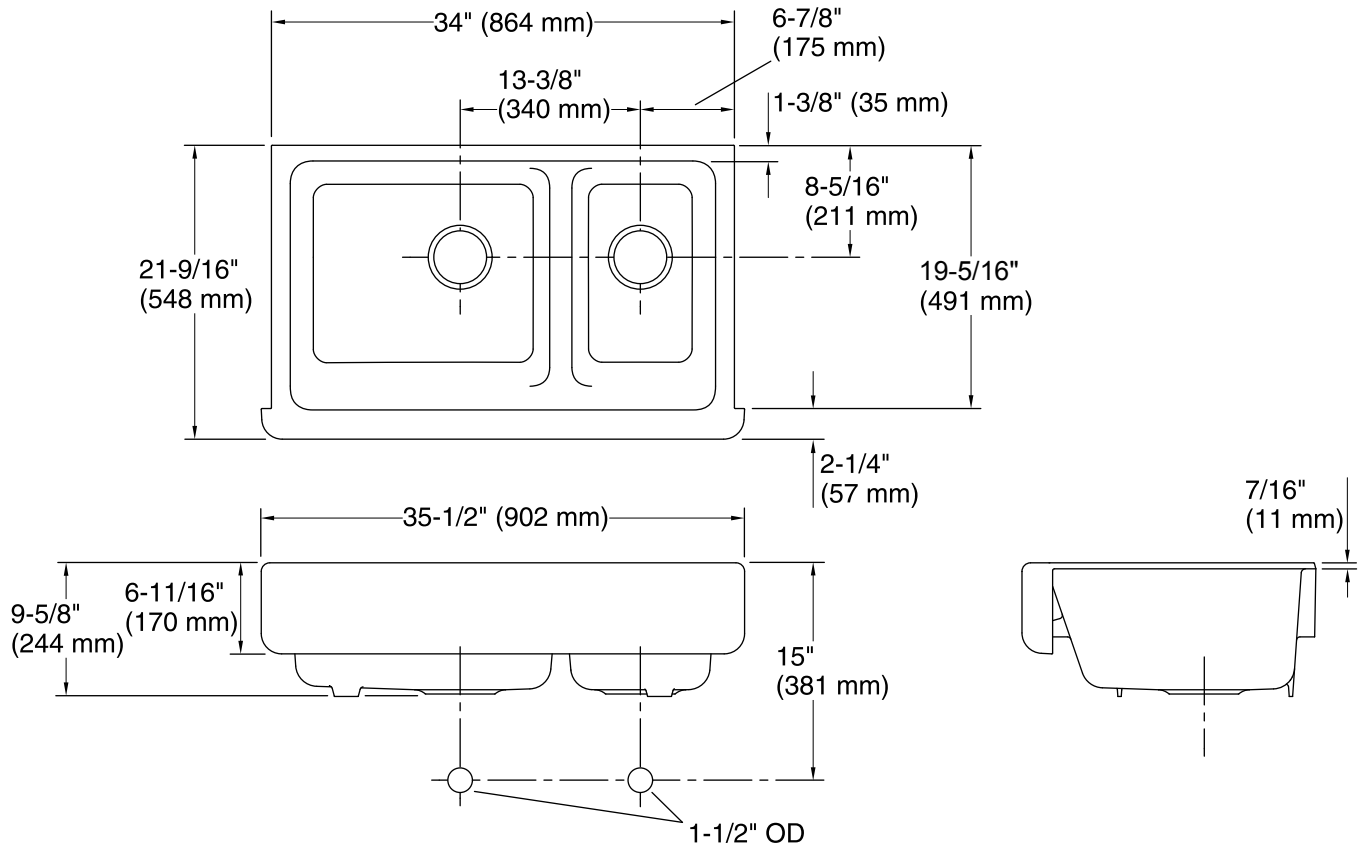

### Technical Information

All product dimensions are nominal.

Bowl configuration:	Large/medium
Installation:	Under-mount
Min. base cabinet width:	36" (914 mm)
Bowl area	Length: 18-13/16" (478 mm) Width: 18-1/16" (459 mm) Bowl depth: 9" (229 mm) Water depth: 9" (229 mm)
Bowl area	Length: 10-5/16" (262 mm) Width: 18-1/16" (459 mm) Bowl depth: 9" (229 mm) Water depth: 9" (229 mm)
Drain hole:	3-5/8" (92 mm)

### Notes

Install this product according to the installation guide.

**NOTICE:** The countertop manufacturer or cutter must use the cut-out template provided with the product, or a current one provided by Kohler Co. (call 1-800-4KOHLER). Kohler Co. is not responsible for cut-out errors when the incorrect cut-out template is used.

**IMPORTANT!** The distance from the top edge of the cabinet to the top of the cabinet door must be at least 6-7/8" (175 mm) to install this sink.