

**SECTION E - COMMERCIAL & RESIDENTIAL PLASTICS**

Closet Flanges & Accessories .....	180-184	
Residential Drains .....	185-194	
LevelBest Drain & Cleanout System .....	195-198	
Commercial Drain Bases.....	199-200	
Commercial Spuds & Strainers .....	201-204	
Commercial Drains.....	205-233	
Residential & Light Commercial Cleanouts .....	234-236	
Cleanout Spuds.....	237-238	
Commerical Cleanouts.....	239-244	
Floor Sinks & Accessories .....	245-246	
Roof Drains.....	247	



**Plumbfit Closet Flange**

3" x 4" Fits Flush with Floor  
3" Fits Inside 3" Schedule 40 DWV Pipe



- Long shank
- Six screw holes
- Extra-thick flange with short slots for extra strength
- For 3" units cut pipe 1/8" below floor and remove concrete so unit will fit flush
- 3" has 4 closet bolt slots



PVC		
PART NO.	DESCRIPTION	CTN QTY
C51300	3" less knockout	20
C50300	3" with Knockout	20
C51340	3" x 4" less knockout	20
C50340	3" x 4" with knockout	20

ABS		
PART NO.	DESCRIPTION	CTN QTY
C51301	3" less knockout	20
C50301	3" with Knockout	20
C51341	3" x 4" less knockout	20
C50341	3" x 4" with knockout	20

**Plumbfit Closet Flange**

Fits Over 4" Schedule 40 DWV Pipe



- Extra thick flange with short slots for extra strength
- Six screw holes
- Long shank



PVC		
PART NO.	DESCRIPTION	CTN QTY
C51400	4" less knockout	20
C50400	4" with knockout	20

ABS		
PART NO.	DESCRIPTION	CTN QTY
C51401	4" less knockout	20

**Plumbfit Closet Flange w/Metal Rings**

Fits Over 3" or Inside 4" Schedule 40 DWV Pipe  
Fits Over 4" Schedule 40 DWV Pipe



- Adjustable metal ring
- Two radial slots for closet bolts



PVC		
PART NO.	DESCRIPTION	CTN QTY
C53340	3" x 4" less knockout	20
C52340	3" x 4" with knockout	20
C53400	4" less knockout	20
C52400	4" with knockout	20

ABS		
PART NO.	DESCRIPTION	CTN QTY
C53341	3" x 4" less knockout	20
C52341	3" x 4" with knockout	20
C53401	4" less knockout	20
C52401	4" with knockout	20

**Plumbfit Closet Flange with SS Ring**



- Exclusive 400 grade stainless with plumb fit bodies
- Radial slots for closet bolts; 6 screw holes
- For Schedule 40 DWV pipe



PVC		
PART NO.	DESCRIPTION	CTN QTY
C57234	Inside 3" pipe; 4" long shank less knockout	20
C57236	Inside 3" pipe; 6" long shank less knockout	20
C57134	Over 3" inside 4" less knockout	20
C57034	Over 3" inside 4" with knockout	20
C57334	Over 3" Inside 4"; 6" long shank less knockout	20
C57040	Over 4" pipe with knockout	20
C57140	Over 4" pipe less knockout	20

ABS		
PART NO.	DESCRIPTION	CTN QTY
C58234	Inside 3" pipe; 4" long shank less knockout	20
C58236	Inside 3" pipe; 6" long shank less knockout	20
C58134	Over 3" inside 4" less knockout	20
C58034	Over 3" Inside 4" with knockout	20
C58334	Over 3" Inside 4"; 6" long shank less knockout	20
C58040	Over 4" pipe with knockout	20
C58140	Over 4" pipe less knockout	20

**Offset Plumbfit Closet Flange w/SS Ring**



- Exclusive 400 grade stainless with plumb fit bodies
- Radial slots for closet bolts; 6 screw holes
- For Schedule 40 DWV pipe



PVC		
PART NO.	DESCRIPTION	CTN QTY
C57434	Over 3" Inside 4"; offset less knockout	20

ABS		
PART NO.	DESCRIPTION	CTN QTY
C58434	Over 3" Inside 4"; offset less knockout	20

**Spigot Fit Closet Flange**



- Extra-thick flange with short slots for extra strength
- Six screw holes



PVC		
PART NO.	DESCRIPTION	CTN QTY
C51350	3" less knockout	20
C51450	4" less knockout	20

ABS		
PART NO.	DESCRIPTION	CTN QTY
C51351	3" less knockout	20
C51451	4" less knockout	20

**Plumbfit Closet Flanges w/Adj. Rings**

Fits Over 3" and Inside 4" Schedule 40 DWV Pipe

MADE IN THE  
**USA**



- 6" long shank
- Can be cut to desired length
- Swivel rings

PVC		
PART NO.	DESCRIPTION	CTN QTY
C53600	Metal Ring	10
C53700	Plastic ring	10
ABS		
PART NO.	DESCRIPTION	CTN QTY
C53601	Metal Ring	10
C53701	Plastic ring	10

**3" Closet Flange with Long Barrel**

Fits Inside 3" Schedule 40 DWV

MADE IN THE  
**USA**



- 4" long shank
- Adjustable swivel rings

PVC		
PART NO.	DESCRIPTION	CTN QTY
C50302	3" Metal ring	10
C50306	3" Plastic ring	10
C50304	3" Metal ring	10
C50308	3" Plastic ring	10
ABS		
PART NO.	DESCRIPTION	CTN QTY
C50303	3" Metal ring	10
C50307	3" Plastic ring	10
C50305	3" Metal ring	10
C50309	3" Plastic ring	10

**Plastic Two Finger Flange**

MADE IN THE  
**USA**



- Fits flush
- Patent #: 5,937,450
- Will fit oblong horns
- Pushes easily into 3" or 4" cast iron or Schedule 40 DWV pipe
- ASTM C-564 rubber gasket

NSF

White Plastic		
PART NO.	DESCRIPTION	CTN QTY
C4733P	3" x 3"	6
C4743P	4" x 3"	6
Black Plastic		
PART NO.	DESCRIPTION	CTN QTY
C4733A	3" x 3"	6
C4743A	4" x 3"	6

**Closest Flange w/3-1/2" Extended Threads**

MADE IN THE  
**USA**



PVC		
PART NO.	DESCRIPTION	CTN/MSTR
C54150	with 3-1/2" extended threads	20

**Plumbfit Closet Flanges with Plastic Swivel Ring**

3" x 4" Fits Over 3" or Inside 4" Schedule 40 DWV Pipe

MADE IN THE  
**USA**



- Plastic ring will not deteriorate
- 360° rotation
- 2 radial slots and 2 grooved slots for closet bolts
- 6 screw holes for securing to floor

NSF

PVC		
PART NO.	DESCRIPTION	CTN QTY
C53342	3" x 4" less knockout	20
C54402	3" x 4" offset - less knockout	20
C52342	3" x 4" with knockout	6
ABS		
PART NO.	DESCRIPTION	CTN QTY
C53343	3" x 4" less knockout	20
C54403	3" x 4" offset - less knockout	20
C52343	3" x 4" with knockout	20

**Plumbfit Closet Flanges with Plastic Swivel Ring**

4" Fits Over Schedule 40 DWV Pipe

MADE IN THE  
**USA**



- Plastic ring will not deteriorate
- 360° rotation
- 2 radial slots and 2 grooved slots for closet bolts
- 6 screw holes for securing to floor

NSF

PVC		
PART NO.	DESCRIPTION	CTN QTY
C52402	4" with knockout	10
C53402	4" less knockout	10
ABS		
PART NO.	DESCRIPTION	CTN QTY
C52403	4" with knockout	10
C53403	4" less knockout	10

### 45° Closet Flange

Fits Over 3" DWV with a 4" Sweep



- CSA certified
- With plastic swivel ring
- More versatile than an offset closet flange
- Provides unlimited offset when used in conjunction with a socket x socket 45° elbow



PVC		
PART NO.	DESCRIPTION	CTN QTY
C55043	3" with Plastic ring	20

ABS		
PART NO.	DESCRIPTION	CTN QTY
C55143	3" with Plastic ring	20

### 3" Over Schedule 30 Pipe Closet Flange

MADE IN THE USA



PVC		
PART NO.	DESCRIPTION	CTN QTY
C51150	3" less knockout	20
C52150	3" with knockout	20

### Offset Closet Flange

Fits Over 3" or Inside 4" Schedule 40 DWV Pipe



- 2" Offset
- Four closet bolt slots and two mounting screw holes

MADE IN THE USA



PVC		
PART NO.	DESCRIPTION	CTN QTY
C54340	3" x 4"	20

ABS		
PART NO.	DESCRIPTION	CTN QTY
C54341	3" x 4"	20

### Adjustable Urinal Flange Kits

Socket Fits Over 2" Schedule 40 DWV Pipe

Spigot Fits Inside Hub of Fitting



- 3-1/4" - 7" flange mounting centers
- Kits include bolts, nuts, washers and gasket

	A	B	C	D
Spigot	2-3/8"	1-13/16"	7"	1-11/16"
Socket/Hub	2-11/16"	1-1/2"	7"	1-11/16"

PVC		
PART NO.	DESCRIPTION	CTN QTY
F10001	Spigot outlet	20
F10002	Socket/hub outlet	20

ABS		
PART NO.	DESCRIPTION	CTN QTY
F11001	Spigot Outlet	20
F11002	Socket/hub outlet	20

### Offset Closet Flange with Metal Ring

Fits Over 3" or Inside 4" Schedule 40 DWV Pipe



- Adjustable metal ring
- Two radial slots for closet bolts

MADE IN THE USA



PVC		
PART NO.	DESCRIPTION	CTN QTY
C54400	3" x 4" less knockout	20

ABS		
PART NO.	DESCRIPTION	CTN QTY
C54401	3" x 4" less knockout	20

### Radial Fit Urinal Flange Kits



- Permits parallel alignment using radial slots
- Adjusts to 4" to 6" centers
- Socket and spigot connections
- Kit includes bolts, nuts, washers and gasket

PVC		
PART NO.	DESCRIPTION	CTN QTY
F10003	2" with socket connection	1
F10004	2" with spigot connection	1

ABS		
PART NO.	DESCRIPTION	CTN QTY
F11003	2" with socket connection	1
F11004	2" with spigot connection	1

### 4-Way Offset Closet Flange

Fits Over 3" or Inside 4" Schedule 40 DWV Pipe



- 2" Offset
- 1-13/16" barrel depth

MADE IN THE USA



PVC		
PART NO.	DESCRIPTION	CTN QTY
C54342	3" x 4"	20

ABS		
PART NO.	DESCRIPTION	CTN QTY
C54343	3" x 4"	20

**Closest Flange Extenders**



- Stackable to desired height
- For raising floor height when adding ceramic tile or hardwood

MADE IN THE USA

PVC		
PART NO.	DESCRIPTION	CTN QTY
C88001	1/2" Thick	20
C88501	1/4" Thick	20

**Waxless Gasket**



- Reusable
- Seals closest flange without using wax

MADE IN THE USA

PART NO.	DESCRIPTION	CTN QTY
C88002	Waxless gasket	1

**Closest Flange Rings**



- Fits over 3" or 4" PVC
- Converts 3 and 4" PVC pipe into a toilet ready application

MADE IN THE USA

PVC		
PART NO.	DESCRIPTION	CTN QTY
C51302	3" Ring	10
C51402	4" Ring	10

ABS		
PART NO.	DESCRIPTION	CTN QTY
C51303	3" Ring	10
C51403	4" Ring	10

**Closest Flange Repair Ring**



- Securely attaches to concrete or wood sub-floor
- Replaces most closest rings
- Corrosion resistant
- Mounting ears offset by 1/8" to allow closet bolts to be installed

PART NO.	DESCRIPTION	CTN /MSTR
C85000	Closest flange repair ring	20/80

**Set-Rite® Toilet Flange Spacer Kits**



- Code Approved: Water and Gas tight seal!
- Raises existing toilet flange from 1/4" up to 1-5/8"
- Kit includes yellow extender, 4 spacers, gasket & 6 stainless steel screws

PART NO.	DESCRIPTION	CTN QTY
C89500	Etender Kit	5

**Complete Closest Flange Extension Kit with Gaskets**



- Useful when overlaying, replacing or tiling bathroom floors
- Two 3-1/2" closet bolts with washers and nuts
- Anchors toilet bolts when closet ring is broken
- No caulking required
- Has built-in gaskets
- One 1/4" flange & one 1/2" flange

MADE IN THE USA

PART NO.	DESCRIPTION	CTN QTY
C88500	Complete Kit	10
C88502	Kit less bolts	10

**Complete Closest Flange Extension Kit**



- Three 1/4" extenders for easy adjustment
- Two 3-1/2" closet bolts with washers and nuts
- Adhesive caulk and all hardware included

MADE IN THE USA

PART NO.	DESCRIPTION	CTN QTY
C88500C	Complete Kit	10

**Closest Flange Extension Kit**



- No mastic necessary between pieces as with stackable units
- Heavy solid plastic construction
- Two 3-1/2" closet bolts with washers and nuts
- Packaged in display header bag
- One 1/2" flange

MADE IN THE USA

PART NO.	DESCRIPTION	CTN QTY
C88050	1/2"	10

**Set-Rite® Toilet Flange Spacer Kit**



- Set your flange height right the first time!
- Install under the flange during rough-in
- Kit includes 4 spacers: 3/4", 1/2", 1/4" & 1/8"

PART NO.	DESCRIPTION	CTN QTY
C89600	Spacer Kit	12

**Closest Flange Spacer Kit**



- Reusable toilet seal gasket
- For repair or correction of problems resulting from installation errors or remodeling projects
- Complete kit includes: 2 gaskets, 1/2" spacer, 1/4" x 3-1/2" closet bolt kit, 2 plastic shims

MADE IN THE USA

PART NO.	DESCRIPTION	CTN/MSTR
C88600	1" repair ring	1/10

**Gapper Flange**



- Used to repair broken closest flanges
- Individually carded for easy display or bulk

PART NO.	DESCRIPTION	CTN/MSTR
C87100	Repair flange carded	24/240

### Flexible and Rigid Super Shims



- Stackable
- Rigid, can be driven
- Flexible, can be trimmed
- **Priced per bag**
- 10 per bag

MADE IN THE  
**USA**

PART NO.	DESCRIPTION	CTN QTY
S55950	1-1/8" x 1-15/16" x 1/4" flexible	1
S55951	1-1/8" x 1-15/16" x 1/4" rigid	1

### Flexible Super Shims



- 200 Flexible super shims packaged in a convenient refillable "candy bowl" counter display
- **Priced per display**

MADE IN THE  
**USA**

PART NO.	DESCRIPTION	CTN QTY
S55952	200 Flexible super shims	1

### Rigid Super Shims



- 200 Rigid super shims packaged in a convenient refillable "candy bowl" counter display
- **Priced per display**

MADE IN THE  
**USA**

PART NO.	DESCRIPTION	CTN QTY
S55953	200 Rigid super shims	1

### Closet Wedge Shims



- Stackable
- 3/8" width x 1-3/8" length x 5/16" height
- Easily trimmed to desired height
- **Priced per bag or display**

MADE IN THE  
**USA**

PART NO.	DESCRIPTION	CTN/MSTR
S55902	100 shims poly bagged	1 bag of 100
S55903	1000 shims counter display	1 bowl of 1000

### Shower/Floor Drains

Fits Over 2" or Inside 3" Schedule 40 DWV Pipe

MADE IN THE USA



- Low profile for first and second floor installations
- Beveled edge allows for recessed installation
- Reversible clamping ring for additional 1/2" height adjustment
- Brass inserts ensure secure clamping of membrane
- Dual weeps holes
- Recessed sump area for added drainage
- D50001 UPC Listed

PVC

PART NO.	STRAINER	REPL. STRAINER	CTN QTY
D50001	4"SS	C60809	20
D50002	4"PB	C60810	20
D50132	4" PB cast	C60807	20
D50133	4" PB cast w/ring	C60807/C60824	20
D50130	4" NB cast	C60808	20
D50131	4" NB cast w/ring	C60808/C60825	20
D50011	4" CP cast	C60806	20
D50010	4" CP cast w/ring	C60806/C60818	20
D50134	4" CP cast square	C60812	20
D50135	4" PB cast square	C60813	20
D50120	2" x 3" SS w/PT	C60809	1
D50121	2" x 3" PB w/PT	C60810	1
D50122	2" x 3" PB cast w/PT	C60807	1
D50123	2" x 3" CP cast w/PT	C60806	1
D50124	2" x 3" NB cast w/PT	C60808	1

ABS

PART NO.	STRAINER	REPL. STRAINER	CTN QTY
D50301	4" SS	C60809	20
D50302	4" PB	C60810	20
D50332	4" PB cast	C60807	20
D50333	4" PB cast w/ring	C60807/C60824	20
D50330	4" NB cast	C60808	20
D50331	4" NB cast w/ring	C60808/C60825	20
D50311	4" CP cast	C60806	20
D50310	4" CP cast w/ring	C60806/C60818	20
D50334	4" CP cast square	C60812	20
D50335	4" PB cast square	C60813	20

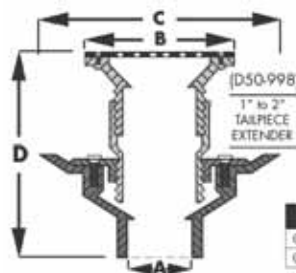

• Use D50998 Tailpiece Extension (listed below) when additional height is needed.

A	B	C	D
Over 2" ppe	4-1/4"	6-1/2"	3-1/4" - 4-3/8"
Over 3" pipe	4-1/4"	6-1/2"	3-1/4" - 4-3/8"

### Tailpiece Extension

MADE IN THE USA



- Use when additional height is needed
- Compensates for thick shower bases

PART NO.	DESCRIPTION	CTN QTY
D50998	1" - 2" tailpiece extension	1

### Shower/Floor Drains w/Brass Tailpiece

Fits Over 2" or Inside 3" Schedule 40 DWV Pipe

MADE IN THE USA



#### BRASS TAILPIECE

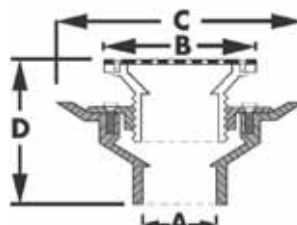

- Low profile for first and second floor installations
- Beveled edge allows for recessed installation
- Reversible clamping ring for additional 1/2" height adjustment
- Brass inserts ensure secure clamping of membrane
- Dual weeps holes
- Recessed sump area for added drainage

A	B	C	D
Over 2" pipe	4-1/4"	6-1/2"	3-1/4" - 4-3/8"
Over 3" pipe	4-1/4"	6-1/2"	3-1/4" - 4-3/8"

PVC

PART NO.	STRAINER	REPL. STRAINER	CTN QTY
D50101	4" SS	D60780	20
D50111	4" CP	D60781	20
D50102	4" PB	D60782	20
D50800	6" CP	-	20
D50802	6" PB	-	20
D50161	4" CP square	C60812	20
D50152	4" PB square	C60813	20

ABS

PART NO.	STRAINER	REPL. STRAINER	CTN QTY
D50401	4" SS	D60780	20
D50411	4" CP	D60781	20
D50402	4" PB	D60782	20
D50830	6" CP	-	20
D50832	6" PB	-	20
D50162	4" CP square	C60812	20
D50153	4" PB square	C60813	20

### Brass Drain Extension



- 2" MIP x 2" FIP for 2" drain spuds
- Use when additional height is required to overcome inconsistent concrete pours
- Height extension from 1-1/2" to 3-1/2"
- Solid brass construction

PART NO.	DESCRIPTION	CTN QTY
D60978	Brass drain extension	1

### "Perfect Low Profile" Drain

Fits Over 2" or Inside 3" PVC Schedule 40 DWV Pipe

MADE IN THE USA

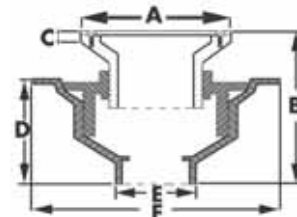

- 3" total height; perfect for multiple stories
- Reversible clamping ring, stainless steel strainer

A	B	C	D	E	F
4-1/4"	MIN: 3" - MAX: 4-1/4"	3/8"	2"	ID: 2-3/8" OD: 3-1/16"	6-5/8"

PVC

PART NO.	DESCRIPTION	CTN QTY
D50PLP	"Perfect low profile" drain	20

**PVC Low Profile Drain**

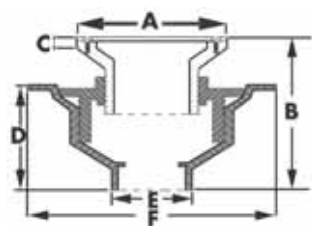

• Primer tapped

MADE IN THE USA

A	B	C	D	E	F
4-1/4"	MIN: 3" - MAX: 4-1/4"	3/8"	2"	ID: 2-3/8" OD: 3-1/16"	6-5/8"

PVC

PART NO.	DESCRIPTION	CTN QTY
D50125	2" x 3" with SS strainer	1
D50126	2" x 3" with NB cast strainer	1

**Shower/Floor Drains with Plastic Tailpiece**

Fits Over 2" Schedule 40 DWV Pipe

COVERALL TOPS  
PLASTIC TAILPIECE

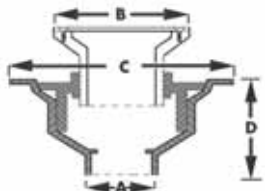

• Screw-down clamping ring has weep holes for secondary drainage

MADE IN THE USA

A	B	C	D
Over 2" pipe	4-1/4"	7	3-5/8" - 5-1/8"
With Ring	4-1/4"	7"	3-3/4" - 5-1/4"

PVC

PART NO.	DESCRIPTION	CTN QTY
D50700	4" SS strainer	10
D50702	4" PB strainer	10
D50708	4" PB strainer cast	10
D50709	4" PB strainer with ring	10
D50701	4" CP strainer	10
D50706	4" NB strainer	10
D50707	4" NB strainer with ring	10

ABS

PART NO.	DESCRIPTION	CTN QTY
D50703	4" SS strainer	10
D50705	4" PB strainer	10
D50726	4" PB strainer cast	10
D50727	4" PB strainer with ring	10
D50704	4" CP strainer	10
D50724	4" NB strainer	10
D50725	4" NB strainer with ring	10

**Shower/Floor Drains with Brass Tailpiece**

Fits Over 2" Schedule 40 DWV Pipe

COVERALL TOPS  
BRASS TAILPIECE

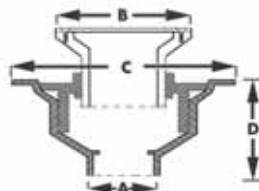

• Screw-down clamping ring has weep holes for secondary drainage

MADE IN THE USA

A	B	C	D
Over 2" pipe	4-1/8" or 6"	7"	3-5/8" - 5-1/4"

PVC

PART NO.	DESCRIPTION	CTN QTY
D50710	4" SS strainer	10
D50712	4" PB strainer	10
D50711	4" CP strainer	10
D50721	6" PB strainer	10
D50720	6" CP strainer	10

ABS

PART NO.	DESCRIPTION	CTN QTY
D50713	4" SS strainer	10
D50715	4" PB strainer	10
D50714	4" CP strainer	10
D50723	6" PB strainer	10
D50722	6" CP strainer	10

**No Caulk Shower Drains**

Pushes Over 2" DWV Pipe

COVERALL TOPS  
NO CAULK

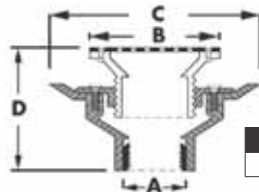

• Tongue-and-grooved beveled clamping ring  
• Brass inserts  
• Supplied with gasket

MADE IN THE USA

A	B	C	D
2" no caulk	4-1/4"	6-1/2"	3-1/2" - 4-3/4"

PVC - PLASTIC TAILPIECE

PART NO.	DESCRIPTION	CTN QTY
D50500	SS Strainer	10
D50510	CP Strainer	10

PVC - BRASS TAILPIECE

PART NO.	DESCRIPTION	CTN QTY
D50501	SS Strainer	10
D50502	PB Strainer	10
D50511	CP Strainer	10

### No Caulk Shower Stall Drains

Fits Over 2" Schedule 40 DWV Pipe

**COVERALL TOPS  
NO CAULK**

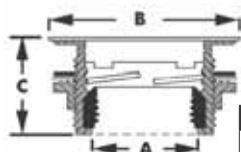

- Snap-in strainer
- Wrench included
- For 2" CTS order gasket separately
- D40140 UPC Listed

A	B	C
2"	4-1/4"	2"

**Plastic Body**

PART NO.	DESCRIPTION	CTN QTY
D40101	SS Strainer (101PNC) with plastic body	20
D40151	White plastic strainer with plastic body	20
D40201	PB strainer with plastic body	10
D40401	White epoxy coated SS str. with plastic body	10

**Brass Body**

PART NO.	DESCRIPTION	CTN QTY
D40140	SS Strainer (140NC) with brass body	20
D40240	PB strainer with brass body	10
D40440	White epoxy coated SS str. with brass body	10

**Snap-in Replacement Strainers**

PART NO.	DESCRIPTION	CTN QTY
D40005	SS replacement strainer for solvent outlet drains	1
D40003	PB replacement strainer	1
D40004	White epoxy coated SS replacement strainer	1
D40006	Replacement Wrench key	1
D40007	2" Schedule 40 DWV gasket	1
D40008	2" CTS replacement gasket	1
D40009	White plastic replacement strainer	1
D40010	SN replacement strainer	1

### Drop-in Shower Stall Drains

Fits Over 2" Schedule 40 DWV Pipe

**DROP-IN**

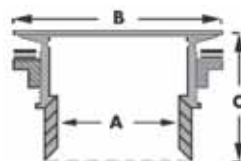

- Drain body drops through shower base
- Locknut tightens from underside
- Snap-in strainer

A	B	C
2"	4-1/4"	2-5/8"

**PVC**

PART NO.	DESCRIPTION	CTN QTY
D41007	2" Solvent outlet with SS strainer	20
D41009	2" Solvent outlet with PB strainer	20
D41008	2" No-caulk/solvent outlet with SS strainer	20

**ABS**

PART NO.	DESCRIPTION	CTN QTY
D41307	2" Solvent outlet with SS strainer	20
D41105	2" Solvent outlet with PB strainer	20

**Snap-In Replacement Strainers**

PART NO.	DESCRIPTION	CTN QTY
D40005	SS for solvent outlet drains	10
D41103	SS for no caulk/solvent drains	10
D41104	Snap-in for D41008	10
D40010	SN	10
D40003	PB	10

### Shower Stall Drains with Receptor Base

Fits Over 2" Schedule 40 DWV Pipe

**RECEPTOR BASE**

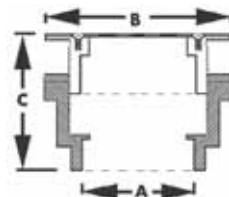

- Allows for secondary drainage
- Accepts knockout test cap for testing

A	B	C
2"	4-1/4"	2"

**PVC**

PART NO.	DESCRIPTION	CTN QTY
D41001	2" Pipe size with SS strainer	25
D41002	2" Pipe size with PB strainer	20
D41003	2" Pipe size with AB strainer	20
D41004	2" Pipe size with SN strainer	20

**ABS**

PART NO.	DESCRIPTION	CTN QTY
D41301	2" Pipe size with SS strainer	20
D41302	2" Pipe size with PB strainer	20
D41303	2" Pipe size with AB strainer	20

**PVC - 2" Offset**

PART NO.	DESCRIPTION	CTN QTY
D41600	2" Offset with SS strainer	20

**ABS - 2" Offset**

PART NO.	DESCRIPTION	CTN QTY
D41601	2" Offset with SS strainer	20

**Replacement Strainers with Screws**

PART NO.	DESCRIPTION	CTN QTY
D41101	SS replacement strainer with screws	1
D41102	PB replacement strainer with screws	1
D41106	AB replacement strainer with screws	1
D41107	SN replacement strainer with screws	1

**General Purpose Drains**

2" x 3" Fits Over 2" or Inside 3" Schedule 40 DWV Pipe

**COVERALL TOPS**

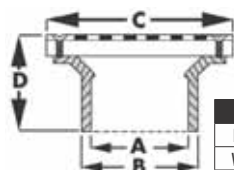

• Brass inserts

A	B	C	D
Less rings: Over 2" pipe	Inside 3" pipe	4-1/4"	1-1/2"
With rings: Over 2" pipe	Inside 3" pipe	4-1/2"	2-1/4"

MADE IN THE USA



PVC

PART NO.	DESCRIPTION	CTN QTY
D54001	with SS strainer	20
D54013	with NB strainer	20
D54014	with NB strainer with ring	20
D54002	with CP strainer	20
D54022	with CP strainer with ring	20
D54015	PB stamped strainer (PVD finish)	20
D54011	PB cast strainer	20
D54012	PB cast strainer with ring	20

ABS

PART NO.	DESCRIPTION	CTN QTY
D54301	with SS strainer	20
D54313	with NB strainer	20
D54314	with NB strainer with ring	20
D54302	with CP strainer	20
D54319	with CP strainer with ring	20
D54315	PB stamped str. (PVD finish)	20
D54311	PB cast strainer	20
D54312	PB cast strainer with ring	20

**General Purpose Drains with Long Body**

2" x 3" Fits Over 2" or Inside 3" Schedule 40 DWV Pipe

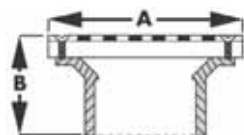

PART NO.	A	B
D54-001L	4-1/4"	2"
D54-002L	4-1/4"	2-1/8"
D54-013L	4-1/4"	2-1/8"
D54-014L	4-1/2"	2-1/4"

MADE IN THE USA

PVC

PART NO.	DESCRIPTION	CTN QTY
D54001L	with SS strainer	20
D54002L	with CP Brass strainer	20
D54013L	with NB strainer	20
D54014L	with NB strainer with ring	20

**General Purpose Drains**

2" x 3" Fits Over 2" or Inside 3" Schedule 40 DWV Pipe  
3" x 4" Fits Over 3" or Inside 4" Schedule 40 DWV Pipe  
4" Fits Over 4" Schedule 40 DWV Pipe

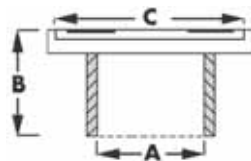

• Cast iron strainer for heavy trucking traffic areas

SIZE	A	B	C
2" x 3"	2-3/8" ID 3" OD	2-1/8"	4-3/4" ID 5-1/8" OD
3" x 4"	3-5/8" ID 4" OD	3-1/8"	4-5/8" ID 5-1/8" OD
4"	4-5/8" ID 5-1/16" OD	3-3/8"	5-3/8" ID 5-3/4" OD

MADE IN THE USA

PVC

PART NO.	DESCRIPTION	CTN QTY
D54016	2" x 3" with CI ring and strainer	1
D54126	3" x 4" with CI ring and strainer	1
D54136	4" with CI ring and strainer	1

ABS

PART NO.	DESCRIPTION	CTN QTY
D54316	2" x 3" with CI ring and strainer	1
D54326	3" x 4" with CI ring and strainer	1
D54336	4" with CI ring and strainer	1

**General Purpose Drains**

3" x 4" Fits Over 3" or Inside 4" DWV Pipe

**COVERALL TOPS**

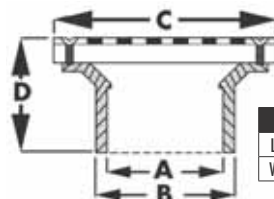

• Brass inserts

A	B	C	D
Less rings: 3" socket	Inside 4" pipe	5-3/16"	2-3/8"
With rings: 3" socket	Inside 4" pipe	5-1/2"	2-11/16"

MADE IN THE USA



PVC

PART NO.	DESCRIPTION	CTN QTY
D54100	with SS strainer	10
D54113	with NB strainer	10
D54114	with NB strainer with ring	10
D54101	with CP strainer	10
D54107	with CP strainer with ring	10
D54111	with PB strainer	10
D54112	with PB strainer with ring	10

ABS

PART NO.	DESCRIPTION	CTN QTY
D54400	with SS strainer	10
D54323	with NB strainer	10
D54324	with NB strainer with ring	10
D54401	with CP strainer	10
D54307	with CP strainer with ring	10
D54321	with PB strainer	10
D54322	with PB strainer with ring	10

### General Purpose Drains

4" Fits Over 4" Schedule 40 DWV Pipe

#### COVERALL TOPS

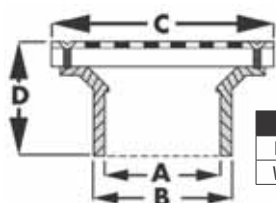

MADE IN THE USA



• Brass Inserts

	A	B	C	D
Less rings: Over 4" pipe	5"	6-3/16"	2-5/8"	
With rings: Over 4" pipe	5"	6-7/16"	2-3/4"	

#### PVC

PART NO.	DESCRIPTION	CTN QTY
D54104	with SS strainer	10
D54130	with NB strainer	10
D54132	with NB strainer with ring	10
D54102	with CP strainer	10
D54137	with CP strainer with ring	10
D54105	with PB strainer	10
D54131	with PB strainer with ring	10
D54133	with 7" PB square strainer	5
D54134	with 7" NB square strainer	5

#### ABS

PART NO.	DESCRIPTION	CTN QTY
D54304	with SS strainer	10
D54330	with NB strainer	10
D54332	with NB strainer with ring	10
D54305	with CP strainer	10
D54337	with CP strainer with ring	10
D54306	with PB strainer	10
D54331	with PB strainer with ring	10
D54333	with 7" PB square strainer	5
D54334	with 7" NB square strainer	5

### 8-1/2" Pan Heavy Duty Traffic Floor Drain

MADE IN THE USA



- Floor sink, area drain, garbage drain, yard drain
- Full plastic 7-1/4" grate; 8-1/2" pan
- Sediment bucket option
- 3 sizes available

#### PVC

PART NO.	DESCRIPTION	CTN QTY
D49820	2" x 3"	1
D49821	3" x 4"	1
D49822	4"	1

#### ABS

PART NO.	DESCRIPTION	CTN QTY
D49823	2" x 3"	1
D49824	3" x 4"	1
D49825	4"	1

#### PVC - With Sediment Bucket

PART NO.	DESCRIPTION	CTN QTY
D49826	2" x 3"	1
D49827	3" x 4"	1
D49828	4"	1

#### ABS - With Sediment Bucket

PART NO.	DESCRIPTION	CTN QTY
D49829	2" x 3"	1
D49830	3" x 4"	1
D49831	4"	1

#### Sediment Bucket Only

PART NO.	DESCRIPTION	CTN QTY
D49924	Sediment bucket	1

### Heavy Duty Traffic Floor Drains

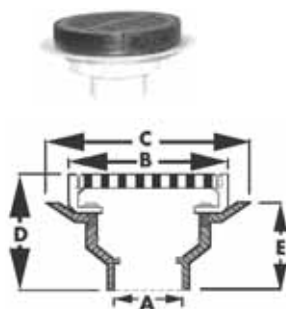

- Floor sink, area drain, garbage drain, yard drain
- 8-1/2" diameter grate
- Brass inserts
- Available with cast iron or plastic grate and ring



	A	B	C	D	E
Over 2" pipe	9"	11"	4-11/16"	3-5/16"	
Over 3" pipe	9"	11"	4-11/16"	3-5/16"	
Over 4" pipe	9"	11"	5-1/16"	3-5/16"	

#### PVC - Full Cast Iron Grate and Ring

PART NO.	DESCRIPTION	CTN QTY
D50092	2" drain	1
D50093	3" drain	1
D50094	4" drain	1
D50089	2" drain with CI sediment bucket	1
D50090	3" drain with CI sediment bucket	1
D50091	4" drain with CI sediment bucket	1

#### ABS - Full Cast Iron Grate and Ring

PART NO.	DESCRIPTION	CTN QTY
D50392	2" drain	1
D50393	3" drain	1
D50394	4" drain	1
D50389	2" drain with CI sediment bucket	1
D50390	3" drain with CI sediment bucket	1
D50391	4" drain with CI sediment bucket	1

#### PVC - Full Plastic Grate and Ring

PART NO.	DESCRIPTION	CTN QTY
D50177	2" drain	1
D50179	3" drain	1
D50181	4" drain	1
D50178	2" drain with debris bucket	1
D50180	3" drain with debris bucket	1
D50182	4" drain with debris bucket	1
D50682	6" drain with debris bucket	1

#### ABS - Full Plastic Grate and Ring

PART NO.	DESCRIPTION	CTN QTY
D50377	2" drain	1
D50379	3" drain	1
D50381	4" drain	1
D50378	2" drain with debris bucket	1
D50380	3" drain with debris bucket	1
D50382	4" drain with debris bucket	1
D50683	6" drain with debris bucket	1

#### PVC - Three-Quarter Plastic Grate and Ring

PART NO.	DESCRIPTION	CTN QTY
D50183	2" drain	1
D50184	3" drain	1
D50185	4" drain	1

#### ABS - Three-Quarter Plastic Grate and Ring

PART NO.	DESCRIPTION	CTN QTY
D50383	2" drain	1
D50384	3" drain	1
D50385	4" drain	1

#### PVC - Half Plastic Grate and Ring

PART NO.	DESCRIPTION	CTN QTY
D50186	2" drain	1
D50187	3" drain	1
D50188	4" drain	1

#### ABS - Half Plastic Grate and Ring

PART NO.	DESCRIPTION	CTN QTY
D50386	2" drain	1
D50387	3" drain	1
D50388	4" drain	1

#### PVC - Replacement Parts

PART NO.	DESCRIPTION	CTN QTY
D50904	Full plastic grate	1
D50906	Three-quarter plastic grate	1
D50908	Half plastic grate	1
D50910	Plastic sediment / debris bucket	1
D50095	CI sediment / debris bucket	1

#### ABS - Replacement Parts

PART NO.	DESCRIPTION	CTN QTY
D50905	Full plastic grate	1
D50907	Three-quarter plastic grate	1
D50909	Half plastic grate	1
D50911	Plastic sediment / debris bucket	1

### All Plastic Snap-in Drains

Fits Into Schedule 40 DWV Pipe

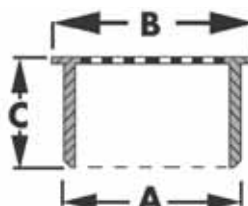

	A	B	C
Inside 2"		2-3/8"	1"
Inside 3"		3-1/2"	1-3/4"
Inside 4"		4-1/2"	2"

#### PVC

PART NO.	DESCRIPTION	CTN QTY
D42002	2"	20
D42003	3"	20
D42004	4"	20

#### ABS

PART NO.	DESCRIPTION	CTN QTY
D42022	2"	20
D42023	3"	20
D42024	4"	20

**Snap-in Drains w/ Stainless Steel Strainers**

Fits Into Schedule 40 DWV Pipe

MADE IN THE **USA**

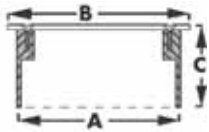

A	B	C
Inside 3" pipe	3-1/2"	2"
Inside 4" pipe	4-1/2"	2"

**PVC**

PART NO.	DESCRIPTION	CTN QTY
D54003	3"	20
D54004	4"	20

**ABS**

PART NO.	DESCRIPTION	CTN QTY
D54005	3"	20
D54006	4"	20

**Snap-in Strainers**

Fits Inside Pipe



• Stainless steel

PART NO.	DESCRIPTION	CTN/MSTR
D59001	3-1/8" strainer fits inside 2" pipe	10/200
D59002	4-1/8" strainer fits inside 3" pipe	10/200
D59003	5-1/8" strainer fits inside 4" pipe	10/100

**Socket Ring**

MADE IN THE **USA**

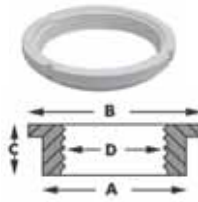

• Solvent welds into Schedule 40 hub to make threaded connection

A	B	C	D
2"	2-3/4"	1/2"	2" FIP
3"	4-1/16"	5/8"	3" FIP
4"	5-1/16"	5/8"	4" FIP

**PVC**

PART NO.	DESCRIPTION	CTN QTY
P48002	2"	20
P48003	3"	20
P48004	4"	20

**ABS**

PART NO.	DESCRIPTION	CTN QTY
P48102	2"	20
P48103	3"	20
P48104	4"	20

**Utility Drains**

MADE IN THE **USA**

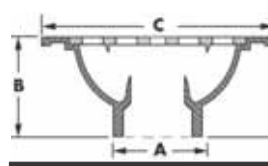

• Snap-in lid  
• Use 2" coupling to connect 6" x 6" to 2" pipe

A	B	C	D
1-1/2" x 2"	2-3/8"	6"	4-9/16"
3" x 4"	3-7/16"	9"	7-11/16"
4"	4-9/16"	9"	7-11/16"
4" w/out stop	4-9/16"	9"	7-11/16"

**PVC**

PART NO.	DESCRIPTION	CTN QTY
D40020	6" x 6" w/pipe stop; 1-1/2" hub; 2" spigot	20
D40021	9" x 9" w/pipe stop; 3" hub; 4" spigot	10
D40023	9" x 9" w/pipe stop; 4" hub	10
D42019	9" x 9" with 4" hub	10

**ABS**

PART NO.	DESCRIPTION	CTN QTY
D42029	9" x 9" with 4" hub	10

**Bell Traps**

MADE IN THE **USA**

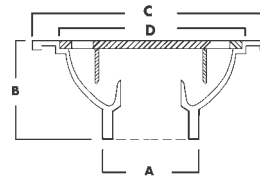

• Snap-in lid  
• Molded bell in lid  
• Use 2" coupling to convert 6" x 6" x 1-1/2" to 2" outlet

A	B	C	D
1-1/2" x 2"	2-3/8"	6"	4-9/16"
3" x 4"	4"	9"	7-3/4"
4"	4-1/2"	9"	7-3/4"

**PVC**

PART NO.	DESCRIPTION	CTN QTY
D42006	6" x 6" with 1-1/2" x 2" outlet	20
D42009	9" x 9" with 3" x 4" outlet	10
D42010	9" x 9" with 4" hub fit outlet	10

**ABS**

PART NO.	DESCRIPTION	CTN QTY
D42011	6" x 6" with 1-1/2" x 2" outlet	20
D42012	9" x 9" with 3" x 4" outlet	10
D42013	9" x 9" with 4" hub fit outlet	10

**Accessories**

PART NO.	DESCRIPTION	CTN QTY
D42007	Lid for the D42006	1
D42008	Lid for the D42009 and D42010	1
D42014	Lid for the D42011	1
D42015	Lid for the D42012 and D42013	1

### Heavy Duty PVC Bell Traps with Hinged Lids

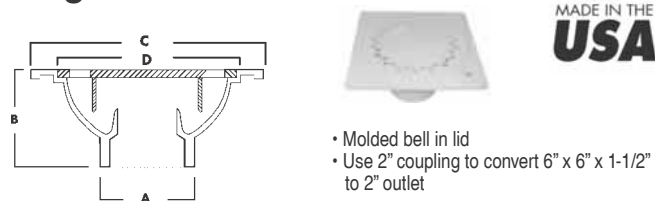

- Molded bell in lid
- Use 2" coupling to convert 6" x 6" x 1-1/2" to 2" outlet

A	B	C	D
1-1/2" x 2"	2-1/2"	6"	4-1/2"
3" x 4"	4-3/8"	9"	7-3/4"
4"	4-1/2"	9"	7-3/4"

**PVC**

PART NO.	DESCRIPTION	CTN QTY
D42006H	6" x 6" with 1-1/2" x 2" outlet	20
D42009H	9" x 9" with 3" x 4" outlet	10
D42010H	9" x 9" with 4" outlet	10

**Accessories**

PART NO.	DESCRIPTION	CTN QTY
D42007H	Lid for the D42006H	1
D42008H	Lid for the D42009H and D42010H	1

### Floor Drains with Traps

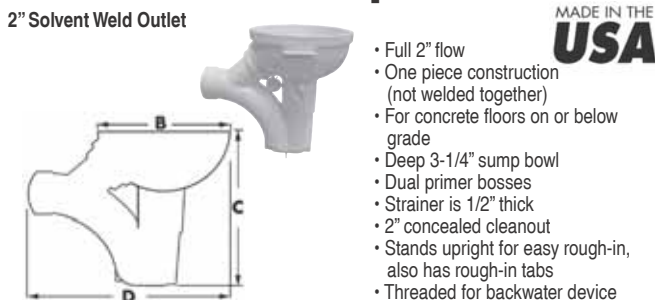

- Full 2" flow
- One piece construction (not welded together)
- For concrete floors on or below grade
- Deep 3-1/4" sump bowl
- Dual primer bosses
- Strainer is 1/2" thick
- 2" concealed cleanout
- Stands upright for easy rough-in, also has rough-in tabs
- Threaded for backwater device

PIPE SIZE	B	C	D
2" IPS	7-5/8"	10-7/8"	11-3/4"

**PVC**

PART NO.	DESCRIPTION	CTN QTY
D50200	with full plastic grate	12
D50208	with 7-1/2" NB strainer	12

**ABS**

PART NO.	DESCRIPTION	CTN QTY
D50600	with full plastic grate	12

**PVC - Accessories**

PART NO.	DESCRIPTION	CTN QTY
D50202	Full grate strainer	1
D50203	Three-quarter grate strainer	1
D50204	Half grate strainer	1

**ABS - Accessories**

PART NO.	DESCRIPTION	CTN QTY
D50205	Full grate strainer	1
D50206	Three-quarter grate strainer	1
D50207	Half grate strainer	1

**Other Accessories**

PART NO.	DESCRIPTION	CTN QTY
D50213	NB strainer	1
B06001	Plastic backwater device	1
B70499	Replacement ball	1

### 4-Way Area Drain

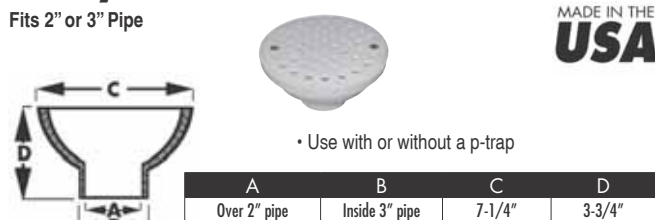

• Use with or without a p-trap

A	B	C	D
Over 2" pipe	Inside 3" pipe	7-1/4"	3-3/4"

**PVC**

PART NO.	DESCRIPTION	CTN QTY
D50201	2" X 3"	15
D50220	2" X 3" without stop	15
B06010	Replacement strainer for D50201	1

**ABS**

PART NO.	DESCRIPTION	CTN QTY
D50601	2" X 3"	15
D50221	2" X 3" without stop	15
B06100	Replacement strainer for D50601	1

### Area Drains



• 5" strainer can be installed as snap-in or screwed in

SIZE	A	B	C	D	E
2" x 3"	2"	3"	5"	6-3/16"	2-3/8"
3" x 4"	3"	4"	5"	6-3/16"	2-3/8"

**PVC**

PART NO.	DESCRIPTION	CTN QTY
D40600	2" x 3"	12
D40601	3" x 4"	12
D40602	PVC Replacement Strainer	1

**ABS**

PART NO.	DESCRIPTION	CTN QTY
D40700	2" x 3"	12
D40701	3" x 4"	12
D40702	ABS Replacement Strainer	1

**Backwater Valves**

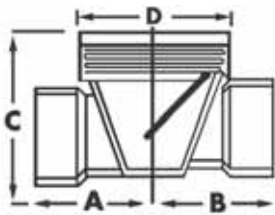

- Sockets are Schedule 40 DWV
- Reduces backflow in drainage system
- Threaded access cover for easy inspection
- Magnetic strip for underground detection
- Flapper and cover have elastomeric gasket to ensure watertight seal
- Stepped construction encourages flow (minimum 1/4" per foot fall)
- The 1-1/2", 2" and 6" have UPC, SBCCI and CSA listings
- The 3" and 4" are NSF and UPC listed

A	B	C	D
1/2"	2-3/16"	2"	4"
2"	2-7/16"	3-7/8"	4"
3"	3-7/8"	5-1/2"	6"
4"	5-3/8"	6-3/4"	8"
6"	7-3/4"	9-1/4"	10-3/4"

**PVC**

PART NO.	DESCRIPTION	CTN QTY
B04150	1-1/2"	1
B04200	2"	1
B04300	3"	1
B04400	4"	1
B04600	6"	1
B04150K	1-1/2" with extension kit & CI lid	1
B04200K	2" with extension kit & CI lid	1
B04300K	3" with extension kit & CI lid	1
B04400K	4" with extension kit & CI lid	1
B04151K	1-1/2" with extension kit & plastic lid	1
B04201K	2" with extension kit & plastic lid	1
B04301K	3" with extension kit & plastic lid	1
B04401K	4" with extension kit & plastic lid	1

**ABS**

PART NO.	DESCRIPTION	CTN QTY
B05150	1-1/2"	1
B05200	2"	1
B05300	3"	1
B05400	4"	1
B05600	6"	1
B05150K	1-1/2" with extension kit & CI lid	1
B05200K	2" with extension kit & CI lid	1
B05300K	3" with extension kit & CI lid	1
B05400K	4" with extension kit & CI lid	1

**Flapper w/Gasket for Backwater Valve**



PART NO.	DESCRIPTION	CTN QTY
B04201	Fits 1-1/2" & 2" backwater valve	1
B04301	Fits 3" backwater valve	1
B04401	Fits 4" backwater valve	1

**Extension Kit**



- Kit includes cast iron top, 16" sleeve and adapter

PART NO.	DESCRIPTION	CTN QTY
B04303	3" complete kit w/CI lid	1
B04403	4" complete kit w/CI lid	1
B04304	3" complete kit w/plastic lid	1
B04404	4" complete kit w/plastic lid	1
BWV200	Ring adapter for 1-1/2" and 2"	1
BWV300	Ring adapter for 3"	1
BWV400	Ring adapter for 4"	1
B04006	6" CI lid for 3" (fits 6" pipe)	1
B04008	8" CI lid for 4" (fits 8" pipe)	1

**Cast Iron Cover Marked "Water" for 6" PVC Pipe**



- Covers 6" PVC and ABS pipe

PART NO.	DESCRIPTION	CTN QTY
B04007	For 6" Plastic Pipe	1

**Condensate Traps**

Manufactured of Schedule 40 DWV Pipe



- One-piece design

PART NO.	DESCRIPTION	CTN QTY
P15050	1/2" p-trap	100
P15075	3/4" p-trap	100
P15175	3/4" mini p-trap	250
R15050	1/2" running trap	100
R15075	3/4" running trap	100

**Mushroom Vent Caps**

Fits 3" or 4" Vent Stacks



- Gray PVC construction
- Includes three installation screws

PART NO.	DESCRIPTION	CTN QTY
M05034	3" x 4"	20

**Flat Top Vent Cap**



- White PVC construction
- Fits 3" and 4" vent stacks
- Includes 2 set screws for securing cap

MADE IN THE  
**USA**

PART NO.	DESCRIPTION	CTN QTY
M05134	Flat top vent cap	20

**PVC Couplings**

4" x 4" Connects 4" Schedule 40 DWV Pipe to 4" SDR



MADE IN THE  
**USA**

PART NO.	DESCRIPTION	CTN QTY
C67440	4" DWV x 4" SDR	10

**PVC Multi-Use Couplings**



- Use to reduce or increase variety of sizes of Schedule 40 pipe

MADE IN THE  
**USA**

PART NO.	DESCRIPTION	CTN QTY
C67230	2" x 3"	1
C67340	3" x 4"	1

**Spigot Adapter**



- 4" DWV x 4" SDR spigot

MADE IN THE  
**USA**

PART NO.	DESCRIPTION	CTN QTY
C67445	4" DWV x 4" SDR spigot	1

**Plastic Over-Fitting Repair Fitting**



- More efficient and less costly way to handle many common PVC re-piping problems
- Available in 1-1/2", 2", 3" and 4" PVC
- Compatible with all fittings
- Raised lettering on hub actually helps seal chemical bond
- Glues over the hub of a fitting on one end and is a 1-1/2" or 2" hub on the other end

MADE IN THE  
**USA**

PVC		
PART NO.	DESCRIPTION	CTN QTY
P22100	1-1/2"	1
P22200	2"	1
P22300	3"	1
P22400	4"	1
ABS		
PART NO.	DESCRIPTION	CTN QTY
P22101	1-1/2"	1
P22201	2"	1

**ADJUST HEIGHT BEFORE & AFTER CONCRETE POUR!**

# LevelBest

## PVC Rough-In Adapter

used for Cast Iron or PVC Drains & Cleanouts

- LevelBest can be used with most manufacturers' products! Industry Standard iron pipe size threads compatible with most adapter and drain bodies.
- LevelBest is the only product on the market that is compatible with most plastic and brass spuds used in the industry.
- LevelBest is the only product that includes the spacer ring that can be used with brass spuds.
- PVC, ABS or CAST IRON drains and cleanouts are compatible with LevelBest.
- LevelBest can be used with tile rings.



**Removable Cap** -  
Remove after concrete is poured

**Optional Spacer** -  
Included for brass spuds

**LevelBest PVC Rough-in Adapter** -  
Allows adjustment to floor level after concrete is poured

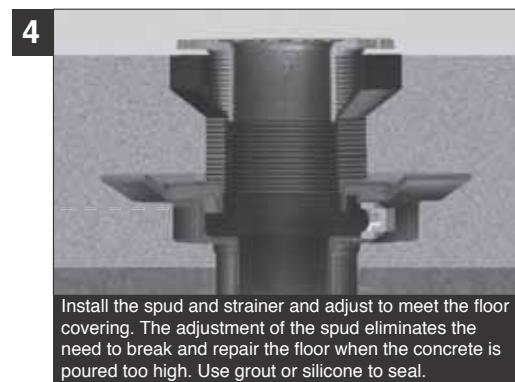
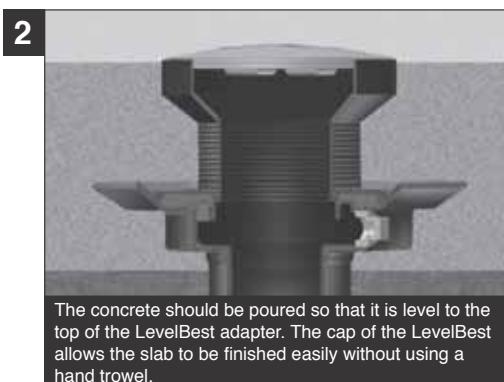
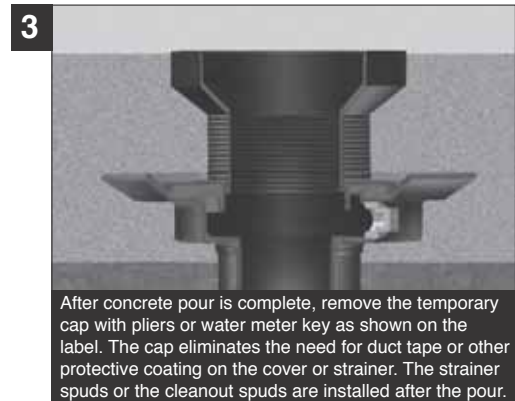
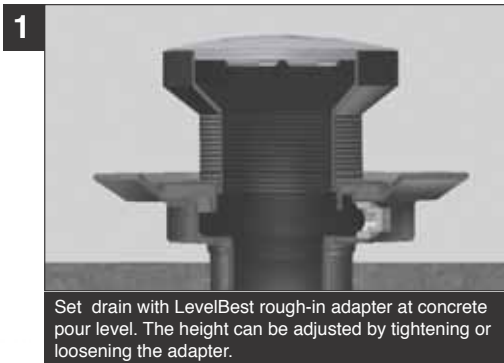

**Adapter**

Allows adjustment to floor level after concrete is poured!

MADE IN THE USA



- PVC, ABS or Cast Iron drains compatible.
- Industry standard iron pipe size threads compatible with most adapter and drain bodies.
- Compatible with most plastic and brass spuds used in the industry
- Includes the spacer ring that can be used with brass spuds
- Can be used with tile rings.
- Drains marked with a **FF** can be built with components available on the "Fast Five Display" (See page 197)

PART NO.	DESCRIPTION	CTN QTY
D50448	3-1/2" x 3" x 6"	1
D50449	4" x 3-1/2" x 6"	1
<b>FF</b> D50450	4" x 3-1/2" x 5"	1
D50451	3-1/2" x 3" x 5"	1
D50452	Replacement Cap	1
D50453	Replacement Ring	1
D50454	Leveling Shim for 5" Strainer	1

**Adapter with Spud & Strainer**

Allows adjustment to floor level after concrete is poured!

MADE IN THE USA



- PVC, ABS or Cast Iron drains compatible.
- Industry standard iron pipe size threads compatible with most adapter and drain bodies.
- Includes the spacer ring that can be used with brass spuds
- Can be used with tile rings.

PART NO.	SIZE	SPUD	STRAINER	CTN QTY
D50522	3-1/2"	3" Plastic	5" NB Round	1
D50523	3-1/2"	3" Metal	5" NB Round	1
D50520	4"	3-1/2" Plastic	5" NB Round	1
D50521	4"	3-1/2" Metal	5" NB Round	1
D50524	3-1/2"	3-1/2" Plastic	6" NB Round	1
D50526	4"	3-1/2" Plastic	6" NB Round	1

**Adapter with Spud & Cleanout**

Allows adjustment to floor level after concrete is poured!

MADE IN THE USA



- PVC, ABS or Cast Iron drains compatible.
- Industry standard iron pipe size threads compatible with most adapter and drain bodies.
- Includes the spacer ring that can be used with brass spuds
- Can be used with tile rings.

PART NO.	SIZE	SPUD	COVER	CTN QTY
D50525	3-1/2"	3" Plastic	6" NB Round	1

**Complete Pipe Fit Drain System**

Allows adjustment to floor level after concrete is poured!

MADE IN THE USA



- Includes the spacer ring that can be used with brass spuds
- Can be used with tile rings.
- Primer tapped with 1/2" IPS plug
- Drains marked with a **FF** can be built with components available on the "Fast Five Display" (See page 197)

PART NO.	PIPE SIZE	SPUD	STRAINER	CTN QTY
D50460	3" x 4"	3" Plastic	5" NB Round	1
D50461	3" x 4"	3" Metal	5" NB Round	1
D50473	3" x 4"	3" Plastic	6" NB Round	1
<b>FF</b> D50486	3" x 4"	3-1/2" Plastic	5" NB Round	1
D50469	3" x 4"	3" Plastic	6" NB Square	1
D50472	4"	3-1/2" Plastic	6" NB Round	1
D50470	4"	3-1/2" Plastic	5" NB Round	1
D50471	4"	3-1/2" Metal	5" NB Round	1
D50465	4"	3" Metal	5" NB Round	1
D50464	4"	3" Plastic	5" NB Round	1
D50474	4"	3" Plastic	6" NB Round	1

**Complete Pipe Fit Cleanout System**

Allows adjustment to floor level after concrete is poured!

MADE IN THE USA



- Includes the spacer ring that can be used with brass spuds
- Can be used with tile rings.
- Primer tapped with 1/2" IPS plug
- Drains marked with a **FF** can be built with components available on the "Fast Five Display" (See page 197)

PART NO.	PIPE SIZE	SPUD	COVER	CTN QTY
C59242	3" x 4"	3" Plastic	5" NB Round	1
C59243	3" x 4"	3" Metal	5" NB Round	1
<b>FF</b> C59252	3" x 4"	3-1/2" Plastic	5" NB Round	1
D50481	3" x 4"	3" Plastic	6" NB Round	1
C59244	over 4"	3" Plastic	5" NB Round	1
C59245	over 4"	3" Metal	5" NB Round	1
C59250	over 4"	3-1/2" Plastic	5" NB Round	1
C59251	over 4"	3-1/2" Metal	5" NB Round	1
D50482	over 4"	3" Plastic	6" NB Round	1
D50480	over 4"	3-1/2" Plastic	6" NB Round	1

**Complete Hub Fit Drain System**

Allows adjustment to floor level after concrete is poured!

MADE IN THE USA



- Includes the spacer ring that can be used with brass spuds
- Can be used with tile rings.

PART NO.	SIZE	SPUD	STRAINER	CTN QTY
D50462	4"	3" Plastic	5" NB Round	1
D50463	4"	3" Metal	5" NB Round	1

### Complete Hub Fit Cleanout System

Allows adjustment to floor level after concrete is poured!

MADE IN THE  
**USA**



- Includes the spacer ring that can be used with brass spuds
- Can be used with tile rings.

PART NO.	SIZE	SPUD	COVER	CTN QTY
C59240	4"	3" Plastic	5" NB Round	1
C59241	4"	3" Metal	5" NB Round	1

### Complete Heavy Duty Drain System

Allows adjustment to floor level after concrete is poured!

MADE IN THE  
**USA**



- Includes the spacer ring that can be used with brass spuds
- Can be used with tile rings.
- Completely adjustable; reversible clamping ring gains additional 1" height
- 8-1/2" Pan primer tapped with 1/2" plug
- Extra weep holes

PART NO.	PIPE SIZE	SPUD	STRAINER	CTN QTY
D49640	4"	3" Plastic	5" NB Round	1
D49641	4"	3" Metal	5" NB Round	1
D49646	4"	3-1/2" Plastic	5" NB Round	1
D49647	4"	3-1/2" Metal	5" NB Round	1
D49644	2" x 3"	3" Plastic	5" NB Round	1
D49645	2" x 3"	3" Metal	5" NB Round	1
D49650	2" x 3"	3-1/2" Plastic	5" NB Round	1
D49651	2" x 3"	3-1/2" Metal	5" NB Round	1
D49642	3" x 4"	3" Plastic	5" NB Round	1
D49643	3" x 4"	3" Metal	5" NB Round	1
D49648	3" x 4"	3-1/2" Plastic	5" NB Round	1
D49649	3" x 4"	3-1/2" Metal	5" NB Round	1
D50477	3"	3-1/2" Plastic	6" NB Round	1
D50479	4"	3-1/2" Plastic	6" NB Round	1

### Complete Heavy Duty Slab Drain System

Allows adjustment to floor level after concrete is poured!

MADE IN THE  
**USA**



- Includes the spacer ring that can be used with brass spuds
- Can be used with tile rings.
- 8-1/2" Pan for applications where no clamping ring is required
- Primer tapped with 1/2" plug
- Completely adjustable

PART NO.	PIPE SIZE	SPUD	STRAINER	CTN QTY
D49656	2" x 3"	3" Plastic	5" NB Round	1
D49657	2" x 3"	3" Metal	5" NB Round	1
D49662	2" x 3"	3-1/2" Plastic	5" NB Round	1
D49663	2" x 3"	3-1/2" Metal	5" NB Round	1
D49654	3" x 4"	3" Plastic	5" NB Round	1
D49655	3" x 4"	3" Metal	5" NB Round	1
D49660	3" x 4"	3-1/2" Plastic	5" NB Round	1
D49661	3" x 4"	3-1/2" Metal	5" NB Round	1
D49652	4"	3" Plastic	5" NB Round	1
D49653	4"	3" Metal	5" NB Round	1
D49658	4"	3-1/2" Plastic	5" NB Round	1
D49659	4"	3-1/2" Metal	5" NB Round	1

### Fast Five Drain Display

Display Part No. Q01555

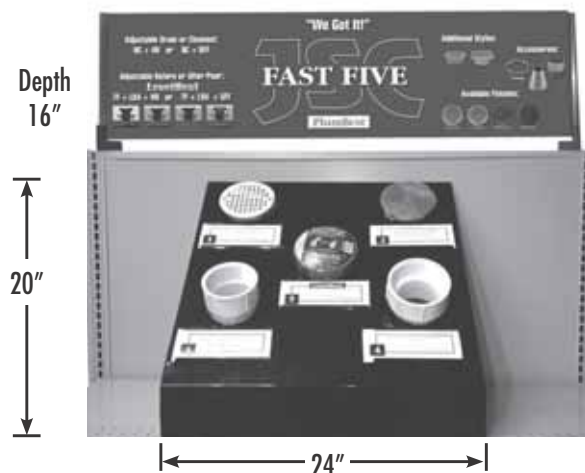

FITS SLOT #	PART NO.	SIZE	SPUD MATERIAL	STRAINER SIZE / MATERIAL	STRAINER DIAMETER	QTY
1	D56214	3-1/2"	Plastic	5" NB Strainer	Round	20
2	D59945	3-1/2"	Plastic	5" NB Cover	Round	20

FITS SLOT #	PART NO.	CONNECTION SIZE	BASE	SPUD SIZE	PRIMER TAP	QTY
3	D52451	3" x 4"	Pipe Fit	3 1/2"	with 1/2" plug	15
4	D52391	3" x 4"	Pipe Fit	4"	with 1/2" plug	10
5	D50450	4" x 3-1/2" x 5"	LevelBest Adpt.	3 1/2"	—	10
—	D49804	3" x 4"	Heavy Duty	3 1/2"	with 1/2" plug	5

**Accessories**

FITS SLOT #	PART NO.	DESCRIPTION	QTY
-	D60996	3-1/2" Metal spud with 5" NB Strainer	5
-	C60805	5" NB cast coverall strainer	5
-	C60503	5" NB cast cleanout cover	5
-	C60823	5" NB ring	5
-	F65400	4" Funnel	2

**Inside Pipe Fit Drain**



• Strainer is the same diameter as the pipe to provide full coverage every time!

MADE IN THE  
**USA**

PART NO.	BASE	STRAINER	CTN QTY
D60130	3" PVC	3-1/2" NB Round	1
D60140	4" PVC	4-1/2" NB Round	1

**Inside Pipe Fit Cleanout**



• Cover is the same diameter as the pipe to provide full coverage every time!

MADE IN THE  
**USA**

PART NO.	BASE	STRAINER	CTN QTY
C60172	3" PVC	3-1/2" NB Round	1
C60170	4" PVC	4-1/2" NB Round	1
C60171	4" PVC	4-1/2" Cast Iron Round	1

**HOW IT WORKS!**

**Concrete Floor Application**

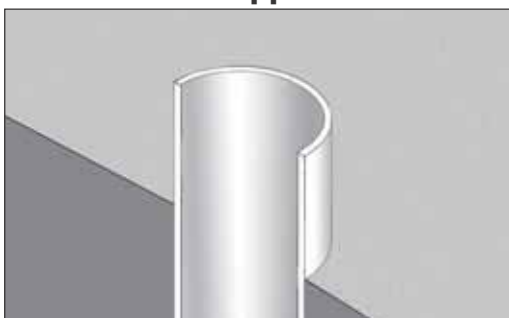

The concrete should be poured so that the pipe stack is above the finished surface.



After concrete is complete, use a Plumbest EZ Stroke pipe saw to cut flush with concrete. Then, use a socket saver or inside pipe cutter to trim pipe 3/8" below concrete surface.

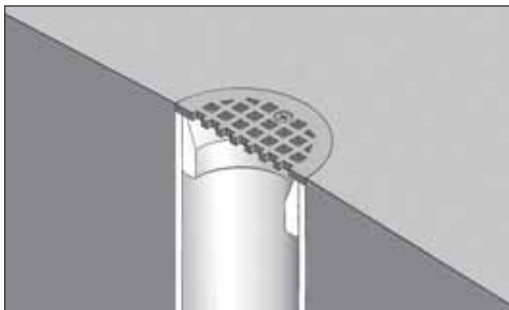

The inside pipe fit drain/cleanout can easily be glued into the pipe creating a level surface once the strainer is installed. No chisel or tape needed!

**Tile Floor Application**

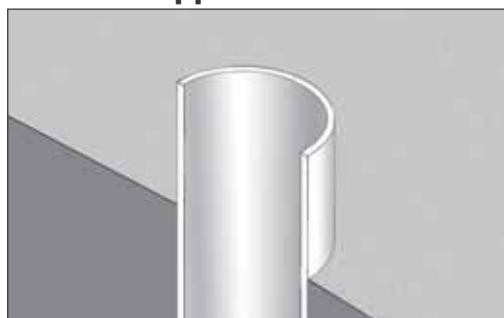

The concrete should be poured so that the pipe stack is above the finished surface.

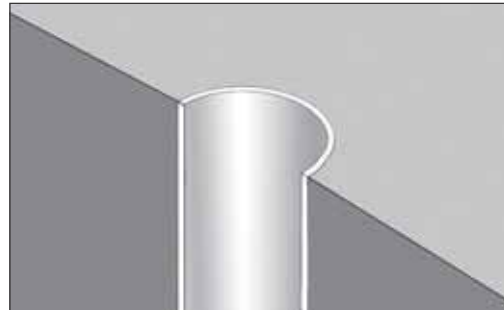

After concrete is complete, use a Plumbest EZ Stroke pipe saw to cut flush with concrete. The inside pipe fit drain/cleanout can easily be glued into the pipe.



Lay tile to the edge of the cover or strainer. No chisel or tape needed!

**Pipe Fit Base**



PVC				
PART NO.	PIPE SIZE	SCH 40 DWV PIPE	SPUD SIZE	CTN QTY
D52120	2"	over 2" w/PT	2"	20
D52012	2"	over 2" and inside 3"	2"	20
D52013	3"	over 3"	3"	10
D52450	3" x 4"	over 3" and inside 4" w/PT	3"	10
D52400	3" x 4"	over 3" and inside 4"	3-1/2"	10
D52451	3" x 4"	over 3" and inside 4" w/PT	3-1/2"	10
D52005	4"	over 4"	3-1/2"	10
D52452	4"	over 4" w/PT	3-1/2"	10
D52014	4"	over 4"	4"	10
D52453	4"	over 4" w/PT	4"	10

ABS				
PART NO.	PIPE SIZE	SCH 40 DWV PIPE	SPUD SIZE	CTN QTY
D52112	2"	over 2" and inside 3"	2"	20
D52016	3"	over 3"	3"	10
D52460	3" x 4"	over 3" and inside 4" w/PT	3"	10
D52500	3" x 4"	over 3" and inside 4"	3-1/2"	10
D52461	3" x 4"	over 3" and inside 4" w/PT	3-1/2"	10
D52462	3" x 4"	over 3" and inside 4" w/PT	4"	10
D52105	4"	over 4"	3-1/2"	10
D52462	4"	over 4" w/PT	3-1/2"	10
D52017	4"	over 4"	4"	10
D52463	4"	over 4" w/PT	4"	10

**Inside Pipe Fit Base**



PVC				
PART NO.	PIPE SIZE	SCH 40 DWV PIPE	SPUD SIZE	CTN QTY
D52023	3"	inside 3"	2"	1
D52004	4"	inside 4"	3"	1

ABS				
PART NO.	PIPE SIZE	SCH 40 DWV PIPE	SPUD SIZE	CTN QTY
D52123	3"	inside 3"	2"	1
D52104	4"	inside 4"	3"	1

**Hub Fit Bases**



PVC				
PART NO.	PIPE SIZE	SCH 40 DWV PIPE	SPUD SIZE	CTN QTY
D52003	4"	inside 4" hub	3-1/2"	1

ABS				
PART NO.	PIPE SIZE	SCH 40 DWV PIPE	SPUD SIZE	CTN QTY
D52103	4"	inside 4" hub	3-1/2"	1

**Heavy Duty Bases with Clamping Ring**



- Completely adjustable; reversible clamping ring gains additional 1" height
- 8-1/2" Pan
- Gray PVC / Black ABS
- Extra weep holes
- Primer tapped with 1/2" plug



PVC				
PART NO.	PIPE SIZE	SCH 40 DWV PIPE	SPUD SIZE	CTN QTY
D49800	2" x 3"	over 2" and inside 3"	3"	1
D49801	2" x 3"	over 2" and inside 3"	3-1/2"	1
D49802	2" x 3"	over 2" and inside 3"	4"	1
D49803	3" x 4"	over 3" and inside 4"	3"	1
D49804	3" x 4"	over 3" and inside 4"	3-1/2"	1
D49805	3" x 4"	over 3" and inside 4"	4"	1
D49806	4"	over 4"	3"	1
D49807	4"	over 4"	3-1/2"	1
D49808	4"	over 4"	4"	1

ABS				
PART NO.	PIPE SIZE	SCH 40 DWV PIPE	SPUD SIZE	CTN QTY
D49810	2" x 3"	over 2" and inside 3"	3"	1
D49811	2" x 3"	over 2" and inside 3"	3-1/2"	1
D49812	2" x 3"	over 2" and inside 3"	4"	1
D49813	3" x 4"	over 3" and inside 4"	3"	1
D49814	3" x 4"	over 3" and inside 4"	3-1/2"	1
D49815	3" x 4"	over 3" and inside 4"	4"	1
D49816	4"	over 4"	3"	1
D49817	4"	over 4"	3-1/2"	1
D49818	4"	over 4"	4"	1

**Slab Drain Bases**



- 8-1/2" Pan for applications where no clamping ring is required
- Spud threads directly into base
- Primer tapped with 1/2" plug
- Gray PVC / Black ABS
- Completely adjustable

MADE IN THE  
**USA**

**PVC**

PART NO.	PIPE SIZE	SCH 40 DWV PIPE	SPUD SIZE	CTN QTY
D49850	2" x 3"	over 2" and inside 3"	3"	1
D49851	2" x 3"	over 2" and inside 3"	3-1/2"	1
D49852	2" x 3"	over 2" and inside 3"	4"	1
D49853	3" x 4"	over 3" and inside 4"	3"	1
D49854	3" x 4"	over 3" and inside 4"	3-1/2"	1
D49855	3" x 4"	over 3" and inside 4"	4"	1
D49856	4"	over 4"	3"	1
D49857	4"	over 4"	3-1/2"	1
D49858	4"	over 4"	4"	1

**ABS**

PART NO.	PIPE SIZE	SCH 40 DWV PIPE	SPUD SIZE	CTN QTY
D49860	2" x 3"	over 2" and inside 3"	3"	1
D49861	2" x 3"	over 2" and inside 3"	3-1/2"	1
D49862	2" x 3"	over 2" and inside 3"	4"	1
D49863	3" x 4"	over 3" and inside 4"	3"	1
D49864	3" x 4"	over 3" and inside 4"	3-1/2"	1
D49865	3" x 4"	over 3" and inside 4"	4"	1
D49866	4"	over 4"	3"	1
D49867	4"	over 4"	3-1/2"	1
D49868	4"	over 4"	4"	1

**Heavy Duty Bases**



- 10" Pan
- Primer tapped, includes 1/2" plug
- Adjustable

MADE IN THE  
**USA**



**PVC**

PART NO.	PIPE SIZE	SCH 40 DWV PIPE	SPUD SIZE	CTN QTY
D52202	2"	over 2"	3-1/2"	1
D52205	2"	over 2"	4"	1
D52203	3"	over 3"	3-1/2"	1
D52206	3"	over 3"	4"	1
D52204	4"	over 4"	3-1/2"	1
D52207	4"	over 4"	4"	1
D52216	6"	over 6"	3-1/2"	1
D52217	6"	over 6"	4"	1

**ABS**

PART NO.	PIPE SIZE	SCH 40 DWV PIPE	SPUD SIZE	CTN QTY
D52302	2"	over 2"	3-1/2"	1
D52305	2"	over 2"	4"	1
D52303	3"	over 3"	3-1/2"	1
D52306	3"	over 3"	4"	1
D52304	4"	over 4"	3-1/2"	1
D52307	4"	over 4"	4"	1
D52316	6"	over 6"	3-1/2"	1
D52317	6"	over 6"	4"	1

**Round Strainers w/2" Plastic Spuds**



PVC			
PART NO.	IPS	STRAINER	CTN QTY
D50980	2"	4" SS	1
D50987	2"	4" CP	1
D50988	2"	4" CP with ring	1
D50985	2"	4" NB	1
D50986	2"	4" NB with ring	1
D50983	2"	4" PB cast	1
D50982	2"	4" PB stamped	1
D50984	2"	4" PB with ring	1
ABS			
PART NO.	IPS	STRAINER	CTN QTY
D57980	2"	4" SS	1
D57987	2"	4" CP	1
D57988	2"	4" CP with ring	1
D57985	2"	4" NB	1
D57986	2"	4" NB with ring	1
D57983	2"	4" PB cast	1
D57982	2"	4" PB stamped	1
D57984	2"	4" PB with ring	1

**Round Strainers w/3-1/2" Plastic Spuds**



PVC			
PART NO.	IPS	STRAINER	CTN QTY
D56211	3-1/2"	5" SS	1
D56216	3-1/2"	5" CP	1
D56217	3-1/2"	5" CP with ring	1
D56214	3-1/2"	5" NB	1
D56215	3-1/2"	5" NB with ring	1
D56212	3-1/2"	5" PB	1
D56213	3-1/2"	5" PB with ring	1
D56106	3-1/2"	6" SS	1
D56206	3-1/2"	6" CP	1
D56209	3-1/2"	6" CP with ring	1
D56406	3-1/2"	6" NB	1
D56407	3-1/2"	6" NB with ring	1
D56306	3-1/2"	6" PB	1
D56307	3-1/2"	6" PB with ring	1
ABS			
PART NO.	IPS	STRAINER	CTN QTY
D57211	3-1/2"	5" SS	1
D57216	3-1/2"	5" CP	1
D57217	3-1/2"	5" CP with ring	1
D57214	3-1/2"	5" NB	1
D57215	3-1/2"	5" NB with ring	1
D57212	3-1/2"	5" PB	1
D57213	3-1/2"	5" PB with ring	1
D57106	3-1/2"	6" SS	1
D57206	3-1/2"	6" CP	1
D57209	3-1/2"	6" CP with ring	1
D57406	3-1/2"	6" NB	1
D57407	3-1/2"	6" NB with ring	1
D57306	3-1/2"	6" PB	1
D57307	3-1/2"	6" PB with ring	1

**Round Strainers w/3" Plastic Spuds**



PVC			
PART NO.	IPS	STRAINER	CTN QTY
D56105	3"	6" SS	1
D56205	3"	6" CP	1
D56210	3"	6" CP with ring	1
D56405	3"	6" NB	1
D56404	3"	6" NB with ring	1
D56305	3"	6" PB	1
D56304	3"	6" PB with ring	1
ABS			
PART NO.	IPS	STRAINER	CTN QTY
D57105	3"	6" SS	1
D57205	3"	6" CP	1
D57210	3"	6" CP with ring	1
D57405	3"	6" NB	1
D57404	3"	6" NB with ring	1
D57305	3"	6" PB	1
D57304	3"	6" PB with ring	1

**Round Strainers w/4" Plastic Spuds**



PVC			
PART NO.	IPS	STRAINER	CTN QTY
D56107	4"	6" SS	1
D56207	4"	6" CP	1
D56208	4"	6" CP with ring	1
D56408	4"	6" NB	1
D56409	4"	6" NB with ring	1
D56308	4"	6" PB	1
D56309	4"	6" PB with ring	1
ABS			
PART NO.	IPS	STRAINER	CTN QTY
D57107	4"	6" SS	1
D57207	4"	6" CP	1
D57208	4"	6" CP with ring	1
D57408	4"	6" NB	1
D57409	4"	6" NB with ring	1
D57308	4"	6" PB	1
D57309	4"	6" PB with ring	1

**Round Strainers w/3-1/2" Metal Spuds**



PART NO.	IPS	STRAINER	CTN/MSTR
D60986	3-1/2"	4" NB	1/40
D60987	3-1/2"	4" PB	1/40
D60990	3-1/2"	5" CP	1/40
D60996	3-1/2"	5" NB	1/40
D60991	3-1/2"	5" PB	1/40
D60992	3-1/2"	6" CP	1/20
D60997	3-1/2"	6" NB	1/20
D60993	3-1/2"	6" PB	1/20
D60994	3-1/2"	8" CP	1/10
D60998	3-1/2"	8" NB	1/10
D60995	3-1/2"	8" PB	1/10
D60999	3-1/2"	9" NB	1/12
D60989	3-1/2"	9" PB	1/12

**Round Strainers w/2" Metal Spuds**



PART NO.	IPS	STRAINER	CTN/MSTR
D60980	2"	4" SS	1/50
D60981	2"	4" CP	1/50
D60982	2"	4" PB	1/50
D60970	2"	6" CP	1/30
D60975	2"	6" PB	1/30

**Round Strainers w/4" Metal Spuds**



PART NO.	IPS	STRAINER	CTN/MSTR
D60958	4"	5" NB	1/30
D60959	4"	5" PB	1/30
D60940	4"	9" NB	1/8

**Replacement Strainers for Metal Spuds**



PART NO.	DESCRIPTION	FINISH	CTN/MSTR
D60780	Fits D60-980	SS	1/200
D60781	Fits D60-981	CP	1/200
D60782	Fits D60-982	PB	1/200
D60790	Fits D60-990	CP	1/200
D60791	Fits D60-991	PB	1/50
D60792	Fits D60-992	CP	1/50
D60793	Fits D60-993	PB	1/50
D60795	Fits D60-995	PB	1/50
D60966	Fits D60-986	NB	1/50
D60967	Fits D60-987	PB	1/100
D60968	Fits D60-996	NB	1/50
D60969	Fits D60-997	NB	1/20

**Round Strainers w/3" Metal Spuds**



PART NO.	IPS	STRAINER	CTN/MSTR
D60955	3"	5" NB	1/30
D60956	3"	5" PB	1/30
D60945	3"	8" NB	1/12

**Square Strainers w/2" Plastic Spuds**



PVC			
PART NO.	IPS	STRAINER	CTN QTY
D50989	2"	4" CP	1
D50990	2"	4" PB	1
ABS			
PART NO.	IPS	STRAINER	CTN QTY
D57989	2"	4" CP	1
D57990	2"	4" PB	1

**7" Square Strainers w/4" Plastic Spuds**



PVC			
PART NO.	IPS	STRAINER	CTN QTY
D56505	4"	5" NB	1
D56504	4"	5" PB	1
ABS			
PART NO.	IPS	STRAINER	CTN QTY
D57505	4"	5" NB	1
D57504	4"	5" PB	1

**7" Square Strainers w/3" Plastic Spuds**



PVC			
PART NO.	IPS	STRAINER	CTN QTY
D56501	3"	5" NB	1
D56500	3"	5" PB	1
ABS			
PART NO.	IPS	STRAINER	CTN QTY
D57501	3"	5" NB	1
D57500	3"	5" PB	1

**Square Strainers w/3-1/2" Metal Spuds**



PART NO.	IPS	STRAINER	CTN/MSTR
D60954	3-1/2"	5" CP	1/20
D60962	3-1/2"	5" NB	1/20
D60960	3-1/2"	5" PB	1/20
D60963	3-1/2"	6" NB	1/12
D60961	3-1/2"	6" PB	1/12

**7" Square Strainers w/3-1/2" Plastic Spuds**



PVC			
PART NO.	IPS	STRAINER	CTN QTY
D56503	3-1/2"	5" NB	1
D56502	3-1/2"	5" PB	1
ABS			
PART NO.	IPS	STRAINER	CTN QTY
D57503	3-1/2"	5" NB	1
D57502	3-1/2"	5" PB	1

**Strainers**



- 4" Fits 4-1/4" diameter drain and cleanout spuds, D50 (2" x 3") series shower drains and 2" x 3" general purpose drains
- 5" Fits 5" diameter drain and cleanout spuds and 3" x 4" General Purpose Drains
- 6" Fits 6-1/8" diameter drain and cleanout spuds and 4" General Purpose Drains

PART NO.	SIZE	DESCRIPTION	CTN/MSTR
C60809	4"	SS coverall	1/400
D54008	4"	SS fits inside plastic ring	1/100
C60806	4"	CP cast coverall	1/100
C60812	4"	CP cast square coverall	1/100
C60808	4"	NB cast coverall	1/100
C60807	4"	PB cast coverall	1/100
C60813	4"	PB cast square coverall	1/100
C60810	4"	PB PVD finish coverall	1/400
C60814	4"	SN coverall	1/100
D54010	4"	PB fits inside plastic ring	1/100
C60811	5"	SS coverall	1/200
D54108	5"	SS fits inside plastic ring	1/100
C60803	5"	CP cast coverall	1/30
D54109	5"	CP cast fits inside plastic ring	1/30
C60805	5"	NB cast coverall	1/30
C60804	5"	PB cast coverall	1/30
D59100	6"	SS coverall	1/30
C60800	6"	CP cast coverall	1/30
C60802	6"	NB cast coverall	1/30
C60801	6"	PB cast coverall	1/30

**Covers**



- 4" Fits 4-1/4" diameter drain and cleanout spuds, D50 (2" x 3") series shower drains and 2" x 3" general purpose drains
- 5" Fits 5" diameter drain and cleanout spuds and 3" x 4" General Purpose Drains
- 6" Fits 6-1/8" diameter drain and cleanout spuds and 4" General Purpose Drains

PART NO.	SIZE	DESCRIPTION	CTN/MSTR
C60504	4"	NB cast cleanout cover	1/50
C60505	4"	PB cast cleanout cover	1/50
C60503	5"	NB cast cleanout cover	1/50
C60502	5"	PB cast cleanout cover	1/50
C60501	6"	NB cast coverall	1/30
C60500	6"	PB cast coverall	1/30

**Rings**



- 4" Fits 4-1/4" diameter drain and cleanout spuds, D50 (2" x 3") series shower drains and 2" x 3" general purpose drains
- 5" Fits 5" diameter drain and cleanout spuds and 3" x 4" General Purpose Drains
- 6" Fits 6-1/8" diameter drain and cleanout spuds and 4" General Purpose Drains

PART NO.	SIZE	DESCRIPTION	CTN/MSTR
C60818	4"	CP ring	1/200
C60825	4"	NB ring	1/200
C60824	4"	PB ring	1/200
C60819	5"	CP ring	1/100
C60823	5"	NB ring	1/100
C60822	5"	PB ring	1/100
C60817	6"	CP ring	1/80
C60821	6"	NB ring	1/80
C60820	6"	PB ring	1/80

**Spud Extension**



- 2-1/2" - 4" extension for a 3-1/2" drain / cleanout spud
- Use on cast iron or PVC drain bodies when additional height is needed to offset inconsistent concrete pours

PART NO.	SIZE	DESCRIPTION	CTN QTY
D60979	3-1/2"	Spud extension	1

**Funnels**



- Supplied with screws
- Vandal-proof installation
- Fits virtually any floor/shower drain
- Funnel tapped for 10-24 screws which are supplied with washers

PART NO.	SIZE	DESCRIPTION	CTN QTY
F65400	4"	Funnel	1
F65600	6"	Funnel	1

### 3" x 4" Pipe Fit Base with 3-1/2" Plastic Spuds

#### 5" Round Strainers

Fits Over 3" or Inside 4" Schedule 40 DWV Pipe

MADE IN THE USA

NSF M C

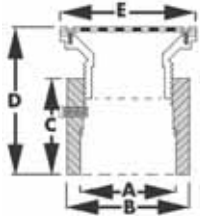

- SS strainers are .06" thick
- Polished Brass, Nickel Bronze and Chrome Plated strainers are 3/16" thick
- Strainers available in SS, PB, NB and CP
- Adjustable (see dimension D)
- Primer tapped, includes 1/2" plug

	A	B	C	D	E
Without ring	Over 3" pipe	Inside 4" pipe	4-1/2"	5-1/16" – 7-1/8"	5-3/16"
With ring	Over 3" pipe	Inside 4" pipe	4-1/2"	5-13/16" – 7-1/4"	5-1/2"

#### PVC

PART NO.	STRAINER	CTN QTY
D53428	5" SS	1
D53429	5" PB	1
D53430	5" PB with ring	1
D53431	5" NB	1
D53432	5" NB with ring	1
D53433	5" CP	1
D53434	5" CP with ring	1

#### ABS

PART NO.	STRAINER	CTN QTY
D53435	5" SS	1
D53436	5" PB	1
D53437	5" PB with ring	1
D53438	5" NB	1
D53439	5" NB with ring	1
D53440	5" CP	1
D53441	5" CP with ring	1

### 3" x 4" Pipe Fit Base with 3-1/2" Plastic Spuds

#### 6" Round Strainer

Fits Over 3" or Inside 4" Schedule 40 DWV Pipe

MADE IN THE USA

NSF M C

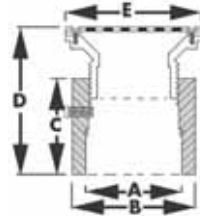

- SS strainers are .06" thick
- Polished Brass, Nickel Bronze and Chrome Plated strainers are 3/16" thick
- Strainers available in SS, PB, NB and CP
- Adjustable (see dimension D)
- Primer tapped, includes 1/2" plug

	A	B	C	D	E
Without ring	Over 3" pipe	Inside 4" pipe	4-1/2"	5-3/4" – 7-1/4"	6-1/8"
With ring	Over 3" pipe	Inside 4" pipe	4-1/2"	6-1/16" – 7-5/16"	6-1/2"

#### PVC

PART NO.	STRAINER	CTN QTY
D53020	6" SS	1
D53022	6" PB	1
D53074	6" PB with ring	1
D53072	6" NB	1
D53076	6" NB with ring	1
D53021	6" CP	1
D53284	6" CP with ring	1

#### ABS

PART NO.	STRAINER	CTN QTY
D53023	6" SS	1
D53025	6" PB	1
D53075	6" PB with ring	1
D53073	6" NB	1
D53077	6" NB with ring	1
D53024	6" CP	1
D53285	6" CP with ring	1

### 3" x 4" Pipe Fit Base with 3-1/2" Plastic Spuds

#### 6" Square Tops and 5" Round Strainer

Fits Over 3" or Inside 4" Schedule 40 DWV Pipe

MADE IN THE USA

NSF M C

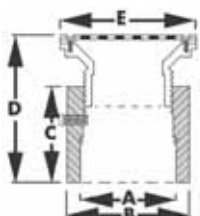

- Primer tapped, includes 1/2" plug
- Adjustable (see dimension D)

	A	B	C	D	E
Square top	Over 3" pipe	Inside 4" pipe	4-1/2"	5-3/4" – 7-1/8"	6"

#### PVC

PART NO.	STRAINER	CTN QTY
D59900	5" NB	1

### 3" x 4" Pipe Fit Base with 3-1/2" Plastic Spuds

#### 7" Square Tops and 5" Round Strainer

Fits Over 3" or Inside 4" Schedule 40 DWV Pipe

MADE IN THE USA

NSF M C

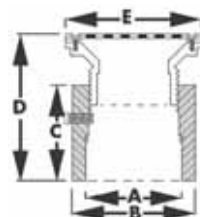

- Strainers are available in PB and NB
- Primer tapped, includes 1/2" plug
- Adjustable (see dimension D)

	A	B	C	D	E
Square top	Over 3" pipe	Inside 4" pipe	4-1/2"	5-15/16" – 7-3/8"	7"

#### PVC

PART NO.	STRAINER	CTN QTY
D53246	5" PB	1
D53248	5" NB	1

#### ABS

PART NO.	STRAINER	CTN QTY
D53247	5" PB	1
D53249	5" NB	1

### 3" x 4" Pipe Fit Base with 3-1/2" Metal Spuds

#### 5", 6", 8" or 9" Round Strainer

Fits Over 3" or Inside 4" Schedule 40 DWV Pipe

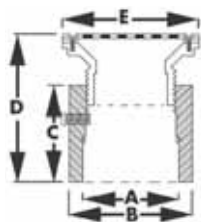

MADE IN THE USA



- Strainers are available in PB, NB and CP
- Primer tapped, includes 1/2" plug
- Adjustable (see dimension D)

	A	B	C	D	E
Metal spud	Over 3" pipe	Inside 4" pipe	4-1/2"	4-7/8" — 6-1/16"	5"
Metal spud	Over 3" pipe	Inside 4" pipe	4-1/2"	5-5/16" — 6-11/16"	6"
Metal spud	Over 3" pipe	Inside 4" pipe	4-1/2"	5-3/8" — 6-7/8"	8"
Metal spud	Over 3" pipe	Inside 4" pipe	4-1/2"	5-3/8" — 6-7/8"	9"

#### PVC

PART NO.	STRAINER	CTN QTY
D53027	5" PB	1
D53124	5" NB	1
D53026	5" CP	1
D53029	6" PB	1
D53125	6" NB	1
D53028	6" CP	1
D53031	8" PB	1
D53138	8" NB	1
D53030	8" CP	1
D53142	9" PB	1
D53140	9" NB	1

#### ABS

PART NO.	STRAINER	CTN QTY
D53033	5" PB	1
D53126	5" NB	1
D53032	5" CP	1
D53035	6" PB	1
D53127	6" NB	1
D53034	6" CP	1
D53037	8" PB	1
D53139	8" NB	1
D53036	8" CP	1
D53143	9" PB	1
D53141	9" NB	1

### 3" x 4" Pipe Fit Base with 3-1/2" Metal Spuds

#### 5" or 6" Square Strainer

Fits Over 3" or Inside 4" Schedule 40 DWV Pipe

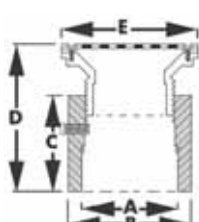

MADE IN THE USA



- Strainers are available in PB and NB
- Primer tapped, includes 1/2" plug
- Adjustable (see dimension D)

	A	B	C	D	E
Square top	Over 3" pipe	Inside 4" pipe	4-1/2"	5-3/4" — 7-1/8"	5" or 6"

#### PVC

PART NO.	STRAINER	CTN QTY
D53078	5" PB	1
D53082	5" NB	1
D53080	6" PB	1
D53084	6" NB	1

#### ABS

PART NO.	STRAINER	CTN QTY
D53079	5" PB	1
D53083	5" NB	1
D53081	6" PB	1
D53085	6" NB	1

### 4" Over Pipe Fit Base with 3-1/2" Plastic Spuds

#### 5" Round Strainer

Fits Over 4" Schedule 40 DWV Pipe

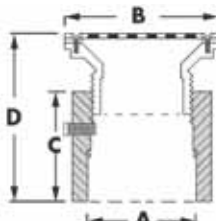

MADE IN THE USA



- Stainless steel strainers are .06" thick
- Strainers are available in SS, PB, NB and CP
- PB, NB and CP strainers are 3/16" thick
- Primer tapped, includes 1/2" plug
- Adjustable (see dimension D)

	A	B	C	D
Without ring	Over 4" pipe	5-3/16"	4-3/4"	6" — 7-3/8"
With ring	Over 4" pipe	5-1/2"	4-3/4"	6-1/8" — 7-1/2"

#### PVC

PART NO.	STRAINER	CTN QTY
D53414	5" SS	1
D53415	5" PB	1
D53416	5" PB with ring	1
D53417	5" NB	1
D53418	5" NB with ring	1
D53419	5" CP	1
D53420	5" CP with ring	1

#### ABS

PART NO.	STRAINER	CTN QTY
D53421	5" SS	1
D53422	5" PB	1
D53423	5" PB with ring	1
D53424	5" NB	1
D53425	5" NB with ring	1
D53426	5" CP	1
D53427	5" CP with ring	1

### 4" Over Pipe Fit Base with 3-1/2" Plastic Spuds

**6" Round Strainer**  
Fits Over 4" Schedule 40 DWV Pipe

**MADE IN THE USA**  
NSF M C

- Stainless steel strainers are .06" thick
- Strainers are available in SS, PB, NB and CP
- PB, NB and CP strainers are 3/16" thick
- Primer tapped, includes 1/2" plug
- Adjustable (see dimension D)

	A	B	C	D
Without ring	Over 4" pipe	6-1/8"	4-3/4"	6" - 7-1/2"
With ring	Over 4" pipe	6-1/2"	4-3/4"	6-1/4" - 7-5/8"

**PVC**

PART NO.	STRAINER	CTN QTY
D53040	6" SS	1
D53042	6" PB	1
D53088	6" PB with ring	1
D53086	6" NB	1
D53090	6" NB with ring	1
D53041	6" CP	1
D53282	6" CP with ring	1

**ABS**

PART NO.	STRAINER	CTN QTY
D53043	6" SS	1
D53045	6" PB	1
D53089	6" PB with ring	1
D53087	6" NB	1
D53091	6" NB with ring	1
D53044	6" CP	1
D53283	6" CP with ring	1

### 4" Over Pipe Fit Base with 3-1/2" Plastic Spuds

**7" Square Top and 5" Round Strainer**  
Fits Over 4" Schedule 40 DWV Pipe

**MADE IN THE USA**  
NSF M C

- Strainers are available in PB and NB
- Strainers are 3/16" thick
- Primer tapped, includes 1/2" plug
- Adjustable (see dimension D)

	A	B	C	D
Square	Over 4" pipe	7"	4-3/4"	5-1/2" - 6-7/8"

**PVC**

PART NO.	STRAINER	CTN QTY
D53250	5" PB	1
D53252	5" NB	1

**ABS**

PART NO.	STRAINER	CTN QTY
D53251	5" PB	1
D53253	5" NB	1

### 4" Over Pipe Fit Base with 3-1/2" Metal Spuds

**5", 6", 8" or 9" Round Strainer**  
Fits Over 4" Schedule 40 DWV Pipe

**MADE IN THE USA**  
NSF M C

- Strainers are available in SS, PB, NB and CP
- PB, NB and CP strainers are 3/16" thick
- Primer tapped, includes 1/2" plug
- Adjustable (see dimension D)

	A	B	C	D
Round	Over 4" pipe	5-3/16"	4-3/4"	5-1/8" - 6-3/8"
Round	Over 4" pipe	6-3/16"	4-3/4"	5-5/16" - 6-5/8"
Round	Over 4" pipe	8"	4-3/4"	5-1/2" - 7"
Round	Over 4" pipe	9"	4-3/4"	5-1/2" - 7-1/8"

**PVC**

PART NO.	STRAINER	CTN QTY
D53047	5" PB	1
D53128	5" NB	1
D53046	5" CP	1
D53049	6" PB	1
D53129	6" NB	1
D53048	6" CP	1
D53051	8" PB	1
D53132	8" NB	1
D53050	8" CP	1
D53136	9" PB	1
D53134	9" NB	1

**ABS**

PART NO.	STRAINER	CTN QTY
D53053	5" PB	1
D53130	5" NB	1
D53052	5" CP	1
D53055	6" PB	1
D53131	6" NB	1
D53054	6" CP	1
D53057	8" PB	1
D53133	8" NB	1
D53056	8" CP	1
D53137	9" PB	1
D53135	9" NB	1

### 4" Over Pipe Fit Base with 3-1/2" Metal Spuds

#### 5" or 6" Square Strainer

Fits Over 4" Schedule 40 DWV Pipe

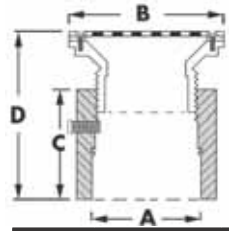

**MADE IN THE USA**



- Strainers are available in PB and NB
- Strainers are 3/16" thick
- Primer tapped, includes 1/2" plug
- Adjustable (see dimension D)

	A	B	C	D
Square	Over 4" pipe	5" or 6"	4-3/4"	5-5/16" — 6-5/8"

**PVC**

PART NO.	STRAINER	CTN QTY
D53092	5" PB	1
D53096	5" NB	1
D53094	6" PB	1
D53098	6" NB	1

**ABS**

PART NO.	STRAINER	CTN QTY
D53093	5" PB	1
D53097	5" NB	1
D53095	6" PB	1
D53099	6" NB	1

### 4" Over Pipe Fit Base with 4" Plastic Spuds

#### 6" Round Strainer

Fits Over 4" Schedule 40 DWV Pipe

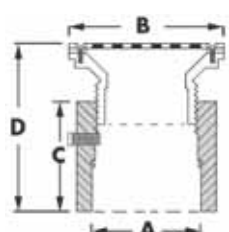

**MADE IN THE USA**



- Stainless steel strainers are .06" thick
- Strainers are available in SS, PB, NB and CP
- PB, NB and CP strainers are 3/16" thick
- Primer tapped, includes 1/2" plug
- Adjustable (see dimension D)

	A	B	C	D
Without ring	Over 4" pipe	6-1/8"	4-3/4"	6" — 7-3/16"
With ring	Over 4" pipe	6-1/2"	4-3/4"	6-1/8" — 7-5/16"

**PVC**

PART NO.	STRAINER	CTN QTY
D53262	6" SS	4
D53263	6" PB	4
D53264	6" PB with ring	4
D53265	6" NB	4
D53266	6" NB with ring	4
D53269	6" CP	4
D53286	6" CP with ring	4

**ABS**

PART NO.	STRAINER	CTN QTY
D53272	6" SS	4
D53273	6" PB	4
D53274	6" PB with ring	4
D53275	6" NB	4
D53276	6" NB with ring	4
D53279	6" CP	4
D53287	6" CP with ring	4

### 4" Over Pipe Fit Base with 4" Plastic Spuds

#### 7" Square Top and 5" Round Strainer

Fits Over 4" Schedule 40 DWV Pipe

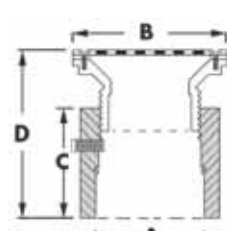

**MADE IN THE USA**



- Strainers are available in PB and NB
- Strainers are 3/16" thick
- Primer tapped, includes 1/2" plug
- Adjustable (see dimension D)

	A	B	C	D
Square	Over 4" pipe	7"	4-3/4"	6-1/16" — 7-3/8"

**PVC**

PART NO.	STRAINER	CTN QTY
D53267	5" PB	1
D53268	5" NB	1

**ABS**

PART NO.	STRAINER	CTN QTY
D53277	5" PB	1
D53278	5" NB	1

### 4" Over Pipe Fit Base with 4" Metal Spuds

#### 5" Round Strainer

Fits Over 4" Schedule 40 DWV Pipe

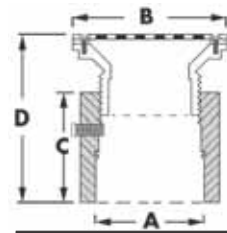

**MADE IN THE USA**



- Strainers are available in PB and NB
- Strainers are 3/16" thick
- Primer tapped, includes 1/2" plug
- Adjustable (see dimension D)

	A	B	C	D
Metal	Over 4" pipe	5"	4-3/4"	6-1/16" — 7-3/8"

**PVC**

PART NO.	STRAINER	CTN QTY
D53308	5" PB	4
D53304	5" NB	4

**ABS**

PART NO.	STRAINER	CTN QTY
D53309	5" PB	4
D53305	5" NB	4

### 3" Over Pipe Fit Base with 3" Plastic Spuds

#### 6" Round Strainer

Fits Over 3" Schedule 40 DWV Pipe

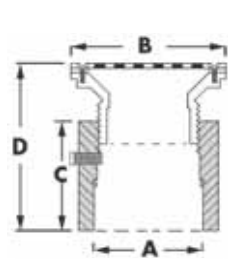

MADE IN THE USA



- Stainless steel strainers are .06" thick
- PB, NB and CP strainers are 3/16" thick
- Strainers are available in SS, PB, NB and CP
- Primer tapped, includes 1/2" plug

	A	B	C	D
Without ring	Over 3" pipe	6-1/8"	3-7/8"	4-13/16" — 5-3/4"
With ring	Over 3" pipe	6-1/2"	3-7/8"	4-15/16" — 5-13/16"

PVC

PART NO.	STRAINER	CTN QTY
D53100	6" SS	1
D53104	6" PB	1
D53108	6" PB with ring	1
D53106	6" NB	1
D53110	6" NB with ring	1
D53102	6" CP	1
D53288	6" CP with ring	1

ABS

PART NO.	STRAINER	CTN QTY
D53101	6" SS	1
D53105	6" PB	1
D53109	6" PB with ring	1
D53107	6" NB	1
D53111	6" NB with ring	1
D53103	6" CP	1
D53289	6" CP with ring	1

### 3" Over Pipe Fit Base with 3" Plastic Spuds

#### 7" Square Top and 5" Round Strainer

Fits Over 3" Schedule 40 DWV Pipe

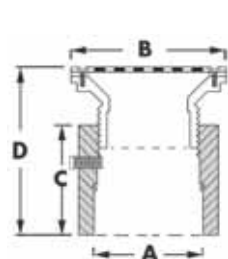

MADE IN THE USA



- Strainers are 3/16" thick
- Strainers are available in PB and NB
- Primer tapped, includes 1/2" plug

	A	B	C	D
Square	Over 3" pipe	7"	3-7/8"	4-13/16" — 6-1/8"

PVC

PART NO.	STRAINER	CTN QTY
D53258	5" PB	1
D53260	5" NB	1

ABS

PART NO.	STRAINER	CTN QTY
D53259	5" PB	1
D53261	5" NB	1

### 3" Over Pipe Fit Base with 3" Metal Spuds

#### 5" Round Strainer

Fits Over 3" Schedule 40 DWV Pipe

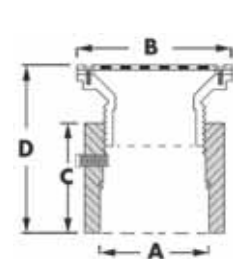

MADE IN THE USA



- PB, NB and CP strainers are 3/16" thick
- Strainers are available in PB and NB
- Primer tapped, includes 1/2" plug

	A	B	C	D
Metal spud	Over 3" pipe	5"	3-7/8"	4-15/16" — 5-3/4"

PVC

PART NO.	STRAINER	CTN QTY
D53312	5" PB	1
D53306	5" NB	1

ABS

PART NO.	STRAINER	CTN QTY
D53313	5" PB	1
D53307	5" NB	1

### 2" Over Pipe Fit Base with 2" Plastic Spuds

#### 4" Round Strainer

Fits Over 2" Schedule 40 DWV Pipe

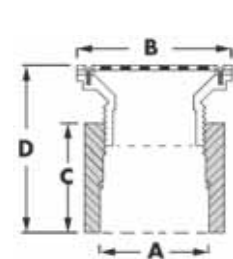

MADE IN THE USA

- Stainless steel strainers are .06" thick
- Strainers are available in SS, PB, NB and CP
- PB, NB and CP strainers are 3/16" thick
- Adjustable (see dimension D)

	A	B	C	D
Without ring	Over 2" pipe	4-1/4"	1-3/4"	3-3/8" — 3-13/16"
With ring	Over 2" pipe	4-1/4"	1-3/4"	3-1/2" — 3-7/8"

PVC

PART NO.	STRAINER	CTN QTY
D53190	4" SS	1
D53194	4" PB stamped	1
D53196	4" PB cast	1
D53200	4" PB with ring	1
D53198	4" NB	1
D53202	4" NB with ring	1
D53192	4" CP	1
D53290	4" CP with ring	1

ABS

PART NO.	STRAINER	CTN QTY
D53191	4" SS	1
D53195	4" PB stamped	1
D53197	4" PB cast	1
D53201	4" PB with ring	1
D53199	4" NB	1
D53203	4" NB with ring	1
D53193	4" CP	1
D53291	4" CP with ring	1

## 2" Over Pipe Fit Base with 2" Plastic Spuds

### 4" Square Strainer

Fits Over 2" Schedule 40 DWV Pipe

MADE IN THE USA

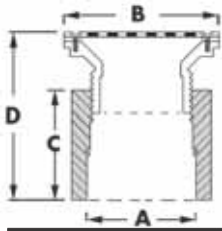

- Strainers are available in PB and CP
- Strainers are 3/16" thick
- Adjustable (see dimension D)

	A	B	C	D
Square	Over 2" pipe	4-1/4"	1-3/4"	3-3/16" – 3-11/16"

PVC

PART NO.	STRAINER	CTN QTY
D53298	4" PB	1
D53296	4" CP	1

ABS

PART NO.	STRAINER	CTN QTY
D53299	4" PB	1
D53297	4" CP	1

## 2" Over Pipe Fit Base with 2" Metal Spuds

### 4" and 6" Round Strainer

Fits Over 2" Schedule 40 DWV Pipe

MADE IN THE USA

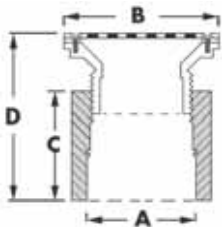

- Stainless steel strainers are .06" thick
- Strainers are available in SS, PB, NB and CP
- PB, NB and CP strainers are 3/16" thick
- Adjustable (see dimension D)

	A	B	C	D
Metal	Over 2" pipe	4-1/4" or 6"	1-3/4"	3-1/8" – 3-5/8"

PVC

PART NO.	STRAINER	CTN QTY
D53204	4" SS	1
D53208	4" PB	1
D53206	4" CP	1
D53218	6" PB	1
D53216	6" CP	1

ABS

PART NO.	STRAINER	CTN QTY
D53205	4" SS	1
D53209	4" PB	1
D53207	4" CP	1
D53219	6" PB	1
D53217	6" CP	1

## 4" Inside Pipe Fit Base with 3" Plastic Spuds

### 6" Round Strainer

Fits Inside 4" Schedule 40 DWV Pipe

MADE IN THE USA

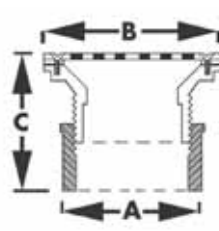

- Stainless steel strainers are .06" thick
- Strainers are available in SS, PB, NB and CP
- PB, NB and CP strainers are 3/16" thick
- Adjustable (see dimension C)

	A	B	C
Without ring	Inside 4" pipe	6-1/8"	3-13/16" – 4-5/8"
With ring	Inside 4" pipe	6-1/2"	4" – 4-13/16"

PVC

PART NO.	STRAINER	CTN QTY
D53230	6" SS	1
D53232	6" PB	1
D53238	6" PB with ring	1
D53234	6" NB	1
D53240	6" NB with ring	1
D53236	6" CP	1
D53292	6" CP with ring	1

ABS

PART NO.	STRAINER	CTN QTY
D53231	6" SS	1
D53233	6" PB	1
D53239	6" PB with ring	1
D53235	6" NB	1
D53241	6" NB with ring	1
D53237	6" CP	1
D53293	6" CP with ring	1

## 4" Inside Pipe Fit Base with 3" Metal Spuds

### 5" Round Strainer

Fits Inside 4" Schedule 40 DWV Pipe

MADE IN THE USA

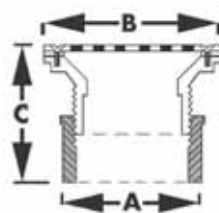

- Strainers are available in PB and NB
- Strainers are 3/16" thick
- Adjustable (see dimension C)

	A	B	C
Metal Spud	Inside 4" pipe	5"	2-5/8" – 3-1/2"

PVC

PART NO.	STRAINER	CTN QTY
D53314	5" PB	1
D53310	5" NB	1

ABS

PART NO.	STRAINER	CTN QTY
D53315	5" PB	1
D53311	5" NB	1

### 3" Inside Pipe Fit Base with 2" Plastic Spuds

**4" Round Strainer**  
Fits Inside 3" Schedule 40 DWV Pipe

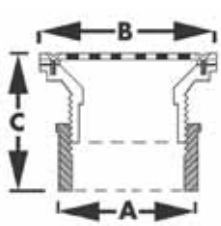

MADE IN THE  
**USA**

- Stainless steel strainers are .06" thick
- Strainers are available in SS, PB, NB and CP
- PB, NB and CP strainers are 3/16" thick
- Adjustable (see dimension C)

	A	B	C
Without ring	Inside 3" pipe	4-1/4"	2-5/8" — 3-7/8"
With ring	Inside 3" pipe	4-1/2"	2-11/16" — 4"

PVC

PART NO.	STRAINER	CTN QTY
D53150	4" SS	1
D53154	4" PB stamped	1
D53156	4" PB cast	1
D53160	4" PB with ring	1
D53158	4" NB	1
D53162	4" NB with ring	1
D53152	4" CP	1
D53294	4" CP with ring	1

ABS

PART NO.	STRAINER	CTN QTY
D53151	4" SS	1
D53155	4" PB stamped	1
D53157	4" PB cast	1
D53161	4" PB with ring	1
D53159	4" NB	1
D53163	4" NB with ring	1
D53153	4" CP	1
D53295	4" CP with ring	1

### 3" Inside Pipe Fit Base with 2" Plastic Spuds

**4" Square Strainer**  
Fits Inside 3" Schedule 40 DWV Pipe

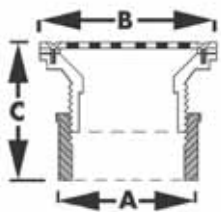

MADE IN THE  
**USA**

- Strainers are available in PB and CP
- Strainers are 3/16" thick
- Adjustable (see dimension C)

	A	B	C
Square	Inside 3" pipe	4-1/4"	2-1/2" — 3-13/16"

PVC

PART NO.	STRAINER	CTN QTY
D53300	4" CP	1
D53302	4" PB	1

ABS

PART NO.	STRAINER	CTN QTY
D53301	4" CP	1
D53303	4" PB	1

### 3" Inside Pipe Fit Base with 2" Metal Spuds

**4" or 6" Round Strainer**  
Fits Inside 3" Schedule 40 DWV Pipe

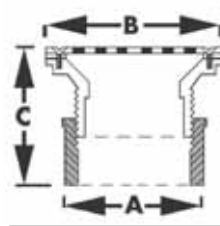

MADE IN THE  
**USA**

- Stainless steel strainers are .06" thick
- Strainers are available in SS, PB and CP
- PB and CP strainers are 3/16" thick
- Adjustable (see dimension C)

	A	B	C
Metal Spud	Inside 3" pipe	4-1/4" or 6"	2-7/16" — 3-3/4"

PVC

PART NO.	STRAINER	CTN QTY
D53180	4" SS	1
D53184	4" PB	1
D53182	4" CP	1
D53188	6" PB	1
D53186	6" CP	1

ABS

PART NO.	STRAINER	CTN QTY
D53181	4" SS	1
D53185	4" PB	1
D53183	4" CP	1
D53189	6" PB	1
D53187	6" CP	1

### 4" Hub Fit Base with 3-1/2" Plastic Spuds

**5" Round Strainer**  
Fits Inside 4" Schedule 40 DWV Pipe

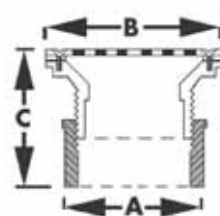

MADE IN THE  
**USA**

- Stainless steel strainers are .06" thick
- Strainers are available in SS, PB, NB and CP
- PB, NB and CP strainers are 3/16" thick
- Adjustable (see dimension C)

	A	B	C
Without ring	4" hub fit	5-3/16"	3" — 4-1/2"
With ring	4" hub fit	5-1/2"	3-1/8" — 4-5/8"

PVC

PART NO.	STRAINER	CTN QTY
D53400	5" SS	1
D53401	5" PB	1
D53402	5" PB with ring	1
D53403	5" NB	1
D53404	5" NB with ring	1
D53405	5" CP	1
D53406	5" CP with ring	1

ABS

PART NO.	STRAINER	CTN QTY
D53407	5" SS	1
D53408	5" PB	1
D53409	5" PB with ring	1
D53410	5" NB	1
D53411	5" NB with ring	1
D53412	5" CP	1
D53413	5" CP with ring	1

### 4" Hub Fit Base with 3-1/2" Plastic Spuds

#### 6" Round Strainer

Fits Inside 4" Schedule 40 DWV Pipe

MADE IN THE USA

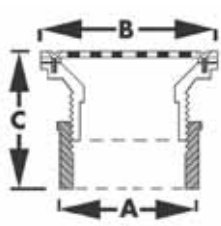

- Stainless steel strainers are .06" thick
- Strainers are available in SS, PB, NB and CP
- PB, NB and CP strainers are 3/16" thick
- Adjustable (see dimension C)

	A	B	C
Without ring	4" hub fit	6-1/8"	3-1/16" - 4-11/16"
With ring	4" hub fit	6-1/2"	3-1/4" - 4-3/4"

**PVC**

PART NO.	STRAINER	CTN QTY
D53017	6" SS	1
D53001	6" PB	1
D53060	6" PB with ring	1
D53058	6" NB	1
D53062	6" NB with ring	1
D53003	6" CP	1
D53280	6" CP with ring	1

**ABS**

PART NO.	STRAINER	CTN QTY
D53018	6" SS	1
D53002	6" PB	1
D53061	6" PB with ring	1
D53059	6" NB	1
D53063	6" NB with ring	1
D53004	6" CP	1
D53281	6" CP with ring	1

### 4" Hub Fit Base with 3-1/2" Metal Spuds

#### 5" or 6" Round Strainer

Fits Inside 4" Schedule 40 DWV Pipe

MADE IN THE USA

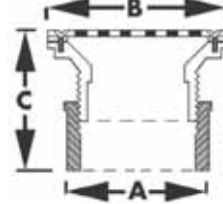

- Strainers are available in PB, NB and CP
- Strainers are 3/16" thick
- Adjustable (see dimension C)

	A	B	C
Round	5" hub fit	5-3/16"	2-3/8" - 3-5/8"
Round	6" hub fit	6-3/16"	2-5/8" - 4"
Round	4" hub fit	8"	2-7/8" - 4-1/2"
Round	4" hub fit	9"	2-7/8" - 4-1/2"

**PVC**

PART NO.	STRAINER	CTN QTY
D53005	5" PB	1
D53120	5" NB	1
D53011	5" CP	1
D53006	6" PB	1
D53121	6" NB	1
D53012	6" CP	1

**ABS**

PART NO.	STRAINER	CTN QTY
D53008	5" PB	1
D53122	5" NB	1
D53014	5" CP	1
D53009	6" PB	1
D53123	6" NB	1
D53015	6" CP	1

### 4" Hub Fit Base with 3-1/2" Metal Spuds

#### 5" or 6" Square Strainer

Fits Inside 4" Schedule 40 DWV Pipe

MADE IN THE USA

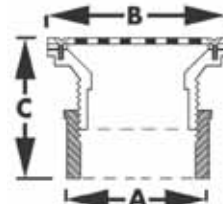

- Strainers are available in PB and NB
- Strainers are 3/16" thick
- Adjustable (see dimension C)

	A	B	C
Square	4" hub fit	5" or 6"	2-3/4" - 4-3/16"

**PVC**

PART NO.	STRAINER	CTN QTY
D53064	5" PB	4
D53068	5" NB	4
D53066	6" PB	4
D53070	6" NB	4

**ABS**

PART NO.	STRAINER	CTN QTY
D53065	5" PB	4
D53069	5" NB	4
D53067	6" PB	4
D53071	6" NB	4

### 4" Heavy Duty Drain Base with 3" Plastic Spuds

**6" Round Strainer**  
Fits Over 4" Schedule 40 DWV Pipe

MADE IN THE USA



- Completely adjustable; reversible clamping ring gains additional 1" height
- Strainers are available in SS, PB, NB and CP
- 8-1/2" pan primer tapped with 1/2" plug
- Gray PVC / Black ABS
- Extra weep holes

	A	B	C	D	E
without ring (SS str.)	Over 4"	6-1/8"	8-9/16"	5-9/16" - 6-11/16"	4-1/4"
without ring	Over 4"	6-1/8"	8-9/16"	5-5/8" - 6-7/8"	4-1/4"
with ring	Over 4"	6-7/16"	8-9/16"	5-13/16" - 7"	4-1/4"

PVC		
PART NO.	STRAINER	CTN QTY
D49201	6" SS	1
D49203	6" PB	1
D49205	6" PB with ring	1
D49207	6" NB	1
D49209	6" NB with ring	1
D49211	6" CP	1
D49213	6" CP with ring	1
ABS		
PART NO.	STRAINER	CTN QTY
D49202	6" SS	1
D49204	6" PB	1
D49206	6" PB with ring	1
D49208	6" NB	1
D49210	6" NB with ring	1
D49212	6" CP	1
D49214	6" CP with ring	1

### 4" Heavy Duty Drain Base with 3-1/2" Plastic Spuds

**5" Round Strainer**  
Fits Over 4" Schedule 40 DWV Pipe

MADE IN THE USA



- Completely adjustable; reversible clamping ring gains additional 1" height
- Strainers are available in SS, PB, NB and CP
- 8-1/2" pan primer tapped with 1/2" plug
- Gray PVC / Black ABS
- Extra weep holes

	A	B	C	D	E
without ring (SS str.)	Over 4"	5-1/4"	8-9/16"	5-1/8" - 6-5/8"	4-1/4"
without ring	Over 4"	5-1/4"	8-9/16"	5-3/16" - 6-3/4"	4-1/4"
with ring	Over 4"	5-9/16"	8-9/16"	5-1/4" - 6-13/16"	4-1/4"

PVC		
PART NO.	STRAINER	CTN QTY
D49223	5" SS	1
D49225	5" PB	1
D49227	5" PB with ring	1
D49229	5" NB	1
D49231	5" NB with ring	1
D49233	5" CP	1
D49235	5" CP with ring	1
ABS		
PART NO.	STRAINER	CTN QTY
D49224	5" SS	1
D49226	5" PB	1
D49228	5" PB with ring	1
D49230	5" NB	1
D49232	5" NB with ring	1
D49234	5" CP	1
D49236	5" CP with ring	1

### 4" Heavy Duty Drain Base with 3" Metal Spuds

**5" Round Strainer**  
Fits Over 4" Schedule 40 DWV Pipe

MADE IN THE USA



- Completely adjustable; reversible clamping ring gains additional 1" height
- Strainers are available in PB and NB
- 8-1/2" pan primer tapped with 1/2" plug
- Gray PVC / Black ABS
- Extra weep holes

	A	B	C	D	E
Metal	Over 4"	5-3/16"	8-9/16"	4-11/16" - 5-7/8"	4-1/4"

PVC		
PART NO.	STRAINER	CTN QTY
D49219	5" PB	1
D49221	5" NB	1
ABS		
PART NO.	STRAINER	CTN QTY
D49220	5" PB	1
D49222	5" NB	1

**4" Heavy Duty Drain Base with 3-1/2" Plastic Spuds**

**6" Round Strainer**

Fits Over 4" Schedule 40 DWV Pipe

MADE IN THE USA

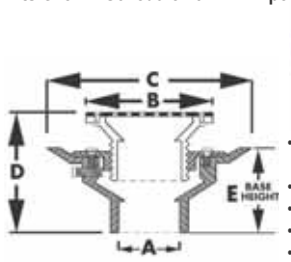

- Completely adjustable; reversible clamping ring gains additional 1" height
- Strainers are available in SS, PB, NB and CP
- 8-1/2" pan primer tapped with 1/2" plug
- Gray PVC / Black ABS
- Extra weep holes

	A	B	C	D	E
without ring (SS str.)	Over 4"	6-1/4"	8-9/16"	5-5/16" — 6-3/4"	4-1/4"
without ring	Over 4"	6-1/4"	8-9/16"	5-7/16" — 6-13/16"	4-1/4"
with ring	Over 4"	6-9/16"	8-9/16"	5-9/16" — 7"	4-1/4"

PVC

PART NO.	STRAINER	CTN QTY
D49237	6" SS	1
D49239	6" PB	1
D49241	6" PB with ring	1
D49243	6" NB	1
D49245	6" NB with ring	1
D49247	6" CP	1
D49249	6" CP with ring	1

ABS

PART NO.	STRAINER	CTN QTY
D49238	6" SS	1
D49240	6" PB	1
D49242	6" PB with ring	1
D49244	6" NB	1
D49246	6" NB with ring	1
D49248	6" CP	1
D49250	6" CP with ring	1

**4" Heavy Duty Drain Base with 3-1/2" Metal Spuds**

**4", 5" or 6" Round Strainer**

Fits Over 4" Schedule 40 DWV Pipe

MADE IN THE USA

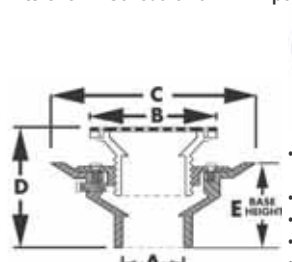

- Completely adjustable; reversible clamping ring gains additional 1" height
- Strainers are available in PB, NB and CP
- 8-1/2" pan primer tapped with 1/2" plug
- Gray PVC / Black ABS
- Extra weep holes

	A	B	C	D	E
4" metal	Over 4"	4-1/8"	8-9/16"	4-5/8" — 5-3/4"	4-1/4"
5" metal	Over 4"	5-3/16"	8-9/16"	4-5/8" — 5-13/16"	4-1/4"
6" metal	Over 4"	6-3/16"	8-9/16"	4-13/16" — 6-1/4"	4-1/4"

PVC

PART NO.	STRAINER	CTN QTY
D49251	4" PB	1
D49253	4" NB	1
D49255	5" PB	1
D49257	5" NB	1
D49259	5" CP	1
D49261	6" PB	1
D49263	6" NB	1
D49265	6" CP	1

ABS

PART NO.	STRAINER	CTN QTY
D49252	4" PB	1
D49254	4" NB	1
D49256	5" PB	1
D49258	5" NB	1
D49260	5" CP	1
D49262	6" PB	1
D49264	6" NB	1
D49266	6" CP	1

### 4" Heavy Duty Drain Base with 4" Plastic Spuds

#### 6" Round Strainer

Fits Over 4" Schedule 40 DWV Pipe

MADE IN THE USA

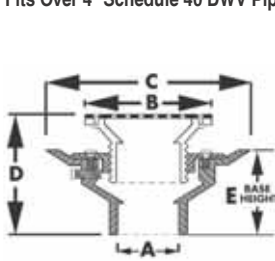

- Completely adjustable; reversible clamping ring gains additional 1" height
- Strainers are available in SS, PB, NB and CP
- 8-1/2" pan primer tapped with 1/2" plug
- Gray PVC / Black ABS
- Extra weep holes

	A	B	C	D	E
without ring (SS str.)	Over 4"	6-3/16"	8-9/16"	5-1/2" — 6-11/16"	4-1/4"
without ring	Over 4"	6-3/16"	8-9/16"	5-9/16" — 6-3/4"	4-1/4"
with ring	Over 4"	6-7/16"	8-9/16"	5-3/4" — 7"	4-1/4"

#### PVC

PART NO.	STRAINER	CTN QTY
D49277	6" SS	1
D49279	6" PB	1
D49281	6" PB with ring	1
D49283	6" NB	1
D49285	6" NB with ring	1
D49287	6" CP	1
D49289	6" CP with ring	1

#### ABS

PART NO.	STRAINER	CTN QTY
D49278	6" SS	1
D49280	6" PB	1
D49282	6" PB with ring	1
D49284	6" NB	1
D49286	6" NB with ring	1
D49288	6" CP	1
D49290	6" CP with ring	1

### 3" x 4" Heavy Duty Drain Base with 3" Plastic Spuds

#### 6" Round Strainer

Fits Over 3" and Inside 4" Schedule 40 DWV Pipe

MADE IN THE USA

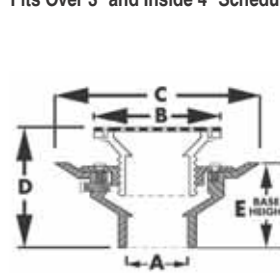

- Completely adjustable; reversible clamping ring gains additional 1" height
- Strainers are available in SS, PB, NB and CP
- 8-1/2" pan primer tapped with 1/2" plug
- Gray PVC / Black ABS
- Extra weep holes

	A	B	C	D	E
without ring (SS str.)	Over 3" Inside 4"	6-1/8"	8-9/16"	5-1/16" — 6-3/16"	5-3/16"
without ring	Over 3" Inside 4"	6-1/8"	8-9/16"	5-1/8" — 6-3/8"	5-3/16"
with ring	Over 3" Inside 4"	6-7/16"	8-9/16"	5-5/16" — 6-1/2"	5-3/16"

#### PVC

PART NO.	STRAINER	CTN QTY
D49101	6" SS	1
D49103	6" PB	1
D49105	6" PB with ring	1
D49107	6" NB	1
D49109	6" NB with ring	1
D49111	6" CP	1
D49113	6" CP with ring	1

#### ABS

PART NO.	STRAINER	CTN QTY
D49102	6" SS	1
D49104	6" PB	1
D49106	6" PB with ring	1
D49108	6" NB	1
D49110	6" NB with ring	1
D49112	6" CP	1
D49114	6" CP with ring	1

### 4" Heavy Duty Drain Base with 4" Metal Spuds

#### 5" Round Strainer

Fits Over 4" Schedule 40 DWV Pipe

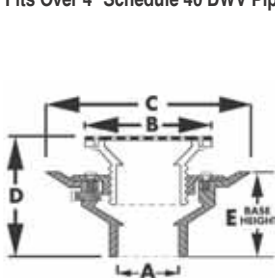

- Completely adjustable; reversible clamping ring gains additional 1" height
- Strainers are available in PB and NB
- 8-1/2" pan primer tapped with 1/2" plug
- Gray PVC / Black ABS
- Extra weep holes

	A	B	C	D	E
Metal	Over 4"	5-3/16"	8-9/16"	4-5/8" — 5-11/16"	4-1/4"

#### PVC

PART NO.	STRAINER	CTN QTY
D49295	5" PB	1
D49297	5" NB	1

#### ABS

PART NO.	STRAINER	CTN QTY
D49296	5" PB	1
D49298	5" NB	1

### 3" x 4" Heavy Duty Drain Base with 3" Metal Spuds

#### 5" Round Strainer

Fits Over 3" and Inside 4" Schedule 40 DWV Pipe

MADE IN THE USA

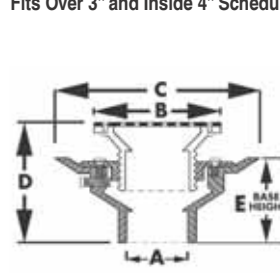

- Completely adjustable; reversible clamping ring gains additional 1" height
- Strainers are available in PB and NB
- 8-1/2" pan primer tapped with 1/2" plug
- Gray PVC / Black ABS
- Extra weep holes

	A	B	C	D	E
Metal	Over 3" Inside 4"	5-3/16"	8-9/16"	4-3/16" — 5-3/8"	5-3/16"

#### PVC

PART NO.	STRAINER	CTN QTY
D49119	5" PB	1
D49121	5" NB	1

#### ABS

PART NO.	STRAINER	CTN QTY
D49120	5" PB	1
D49122	5" NB	1

### 3" x 4" Heavy Duty Drain Base with 3-1/2" Plastic Spuds

#### 5" Round Strainer

Fits Over 3" and Inside 4" Schedule 40 DWV Pipe

MADE IN THE USA

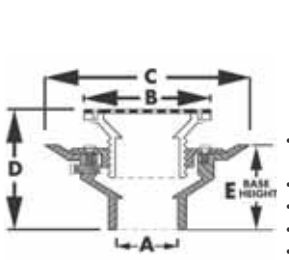

- Completely adjustable; reversible clamping ring gains additional 1" height
- Strainers are available in SS, PB, NB and CP
- 8-1/2" pan primer tapped with 1/2" plug
- Gray PVC / Black ABS
- Extra weep holes

	A	B	C	D	E
without ring (SS str.)	Over 3" Inside 4"	5-1/4"	8-9/16"	4-5/8" — 6-1/8"	5-1/4"
without ring	Over 3" Inside 4"	5-1/4"	8-9/16"	4-11/16" — 6-1/4"	5-1/4"
with ring	Over 3" Inside 4"	5-9/16"	8-9/16"	4-3/4" — 6-5/16"	5-1/4"

**PVC**

PART NO.	STRAINER	CTN QTY
D49123	5" SS	1
D49125	5" PB	1
D49127	5" PB with ring	1
D49129	5" NB	1
D49131	5" NB with ring	1
D49133	5" CP	1
D49135	5" CP with ring	1

**ABS**

PART NO.	STRAINER	CTN QTY
D49124	5" SS	1
D49126	5" PB	1
D49128	5" PB with ring	1
D49130	5" NB	1
D49132	5" NB with ring	1
D49134	5" CP	1
D49136	5" CP with ring	1

### 3" x 4" Heavy Duty Drain Base with 3-1/2" Plastic Spuds

#### 6" Round Strainer

Fits Over 3" and Inside 4" Schedule 40 DWV Pipe

MADE IN THE USA

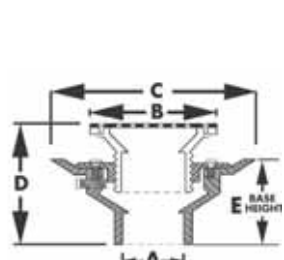

- Completely adjustable; reversible clamping ring gains additional 1" height
- Strainers are available in SS, PB, NB and CP
- 8-1/2" pan primer tapped with 1/2" plug
- Gray PVC / Black ABS
- Extra weep holes

	A	B	C	D	E
without ring (SS str.)	Over 3" Inside 4"	6-1/4"	8-9/16"	4-13/16" — 6-1/4"	5-1/4"
without ring	Over 3" Inside 4"	6-1/4"	8-9/16"	4-15/16" — 6-5/16"	5-1/4"
with ring	Over 3" Inside 4"	6-9/16"	8-9/16"	5-1/16" — 6-1/2"	5-1/4"

**PVC**

PART NO.	STRAINER	CTN QTY
D49137	6" SS	1
D49139	6" PB	1
D49141	6" PB with ring	1
D49143	6" NB	1
D49145	6" NB with ring	1
D49147	6" CP	1
D49149	6" CP with ring	1

**ABS**

PART NO.	STRAINER	CTN QTY
D49138	6" SS	1
D49140	6" PB	1
D49142	6" PB with ring	1
D49144	6" NB	1
D49146	6" NB with ring	1
D49148	6" CP	1
D49150	6" CP with ring	1

### 3" x 4" Heavy Duty Drain Base with 3-1/2" Metal Spuds

#### 4", 5" or 6" Round Strainer

Fits Over 3" and Inside 4" Schedule 40 DWV Pipe

MADE IN THE  
**USA**

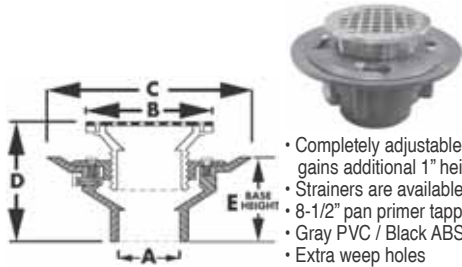

- Completely adjustable; reversible clamping ring gains additional 1" height
- Strainers are available in PB, NB and CP
- 8-1/2" pan primer tapped with 1/2" plug
- Gray PVC / Black ABS
- Extra weep holes

	A	B	C	D	E
4" metal	Over 3" Inside 4"	4-1/8"	8-9/16"	4-1/8" — 5-1/4"	5-1/4"
5" metal	Over 3" Inside 4"	5-3/16"	8-9/16"	4-1/8" — 5-5/16"	5-1/4"
6" metal	Over 3" Inside 4"	6-3/16"	8-9/16"	4-5/16" — 5-3/4"	5-1/4"

**PVC**

PART NO.	STRAINER	CTN QTY
D49151	4" PB	1
D49153	4" NB	1
D49155	5" PB	1
D49157	5" NB	1
D49159	5" CP	1
D49161	6" PB	1
D49163	6" NB	1
D49165	6" CP	1

**ABS**

PART NO.	STRAINER	CTN QTY
D49152	4" PB	1
D49154	4" NB	1
D49156	5" PB	1
D49158	5" NB	1
D49160	5" CP	1
D49162	6" PB	1
D49164	6" NB	1
D49166	6" CP	1

### 3" x 4" Heavy Duty Drain Base with 4" Plastic Spuds

#### 6" Round Strainer

Fits Over 3" and Inside 4" Schedule 40 DWV Pipe

MADE IN THE  
**USA**

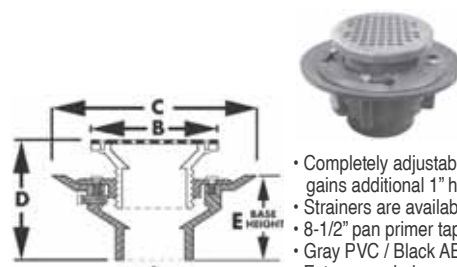

- Completely adjustable; reversible clamping ring gains additional 1" height
- Strainers are available in SS, PB, NB and CP
- 8-1/2" pan primer tapped with 1/2" plug
- Gray PVC / Black ABS
- Extra weep holes

	A	B	C	D	E
Without ring (SS str.)	Over 3" Inside 4"	6-3/16"	8-9/16"	5-1/16" — 6-3/16"	5-1/4"
Without ring	Over 3" Inside 4"	6-3/16"	8-9/16"	5-1/8" — 6-3/8"	5-1/4"
With ring	Over 3" Inside 4"	6-7/16"	8-9/16"	5-5/16" — 6-1/2"	5-1/4"

**PVC**

PART NO.	STRAINER	CTN QTY
D49177	6" SS	1
D49179	6" PB	1
D49181	6" PB with ring	1
D49183	6" NB	1
D49185	6" NB with ring	1
D49187	6" CP	1
D49189	6" CP with ring	1

**ABS**

PART NO.	STRAINER	CTN QTY
D49178	6" SS	1
D49180	6" PB	1
D49182	6" PB with ring	1
D49184	6" NB	1
D49186	6" NB with ring	1
D49188	6" CP	1
D49190	6" CP with ring	1

### 3" x 4" Heavy Duty Drain Base with 4" Metal Spuds

#### 5" Round Strainer

Fits Over 3" and Inside 4" Schedule 40 DWV Pipe

MADE IN THE  
**USA**

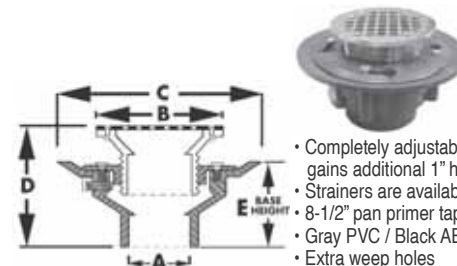

- Completely adjustable; reversible clamping ring gains additional 1" height
- Strainers are available in SS, PB, NB and CP
- 8-1/2" pan primer tapped with 1/2" plug
- Gray PVC / Black ABS
- Extra weep holes

	A	B	C	D	E
Metal	Over 3" Inside 4"	5-3/16"	8-9/16"	4-3/16" — 5-3/8"	5-1/4"

**PVC**

PART NO.	STRAINER	CTN QTY
D49195	5" PB	1
D49197	5" NB	1

**ABS**

PART NO.	STRAINER	CTN QTY
D49196	5" PB	1
D49198	5" NB	1

## 2" x 3" Heavy Duty Drain Base with 3" Plastic Spuds

### 6" Round Strainer

Fits Over 2" and Inside 3" Schedule 40 DWV Pipe

MADE IN THE  
**USA**

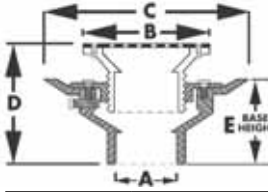

- Completely adjustable; reversible clamping ring gains additional 1" height
- Strainers are available in SS, PB, NB and CP
- 8-1/2" pan primer tapped with 1/2" plug
- Gray PVC / Black ABS
- Extra weep holes

	A	B	C	D	E
Without ring (SS str.)	Over 2" Inside 3"	6-1/8"	8-9/16"	5-1/16" — 6-3/16"	3-3/4"
Without ring	Over 2" Inside 3"	6-1/8"	8-9/16"	5-1/8" — 6-3/8"	3-3/4"
With ring	Over 2" Inside 3"	6-7/16"	8-9/16"	5-5/16" — 6-3/16"	3-3/4"

PVC

PART NO.	STRAINER	CTN QTY
D49001	6" SS	1
D49003	6" PB	1
D49005	6" PB with ring	1
D49007	6" NB	1
D49009	6" NB with ring	1
D49011	6" CP	1
D49013	6" CP with ring	1

ABS

PART NO.	STRAINER	CTN QTY
D49002	6" SS	1
D49004	6" PB	1
D49006	6" PB with ring	1
D49008	6" NB	1
D49010	6" NB with ring	1
D49012	6" CP	1
D49014	6" CP with ring	1

## 2" x 3" Heavy Duty Drain Base with 3" Metal Spuds

### 5" Round Strainer

Fits Over 2" and Inside 3" Schedule 40 DWV Pipe

MADE IN THE  
**USA**

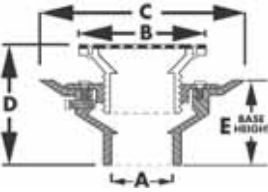

- Completely adjustable; reversible clamping ring gains additional 1" height
- Strainers are available in SS, PB, NB and CP
- 8-1/2" pan primer tapped with 1/2" plug
- Gray PVC / Black ABS
- Extra weep holes

	A	B	C	D	E
Metal	Over 2" Inside 3"	5-3/16"	8-9/16"	4-3/16" — 5-3/8"	3-3/4"

PVC

PART NO.	STRAINER	CTN QTY
D49019	5" PB	1
D49021	5" NB	1

ABS

PART NO.	STRAINER	CTN QTY
D49020	5" PB	1
D49022	5" NB	1

## 2" x 3" Heavy Duty Drain Base with 3-1/2" Plastic Spuds

### 5" Round Strainer

Fits Over 2" and Inside 3" Schedule 40 DWV Pipe

MADE IN THE  
**USA**

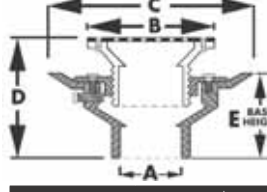

- Completely adjustable; reversible clamping ring gains additional 1" height
- Strainers are available in SS, PB, NB and CP
- 8-1/2" pan primer tapped with 1/2" plug
- Gray PVC / Black ABS
- Extra weep holes

	A	B	C	D	E
Without ring (SS str.)	Over 2" Inside 3"	5-1/4"	8-9/16"	4-5/8" — 6-1/8"	3-3/4"
Without ring	Over 2" Inside 3"	5-1/4"	8-9/16"	4-11/16" — 6-1/4"	3-3/4"
With ring	Over 2" Inside 3"	5-9/16"	8-9/16"	4-3/4" — 6-5/16"	3-3/4"

PVC

PART NO.	STRAINER	CTN QTY
D49023	5" SS	1
D49025	5" PB	1
D49027	5" PB with ring	1
D49029	5" NB	1
D49031	5" NB with ring	1
D49033	5" CP	1
D49035	5" CP with ring	1

ABS

PART NO.	STRAINER	CTN QTY
D49024	5" SS	1
D49026	5" PB	1
D49028	5" PB with ring	1
D49030	5" NB	1
D49032	5" NB with ring	1
D49034	5" CP	1
D49036	5" CP with ring	1

## 2" x 3" Heavy Duty Drain Base with 3-1/2" Plastic Spuds

**6" Round Strainer**  
Fits Over 2" and Inside 3" Schedule 40 DWV Pipe

MADE IN THE  
**USA**

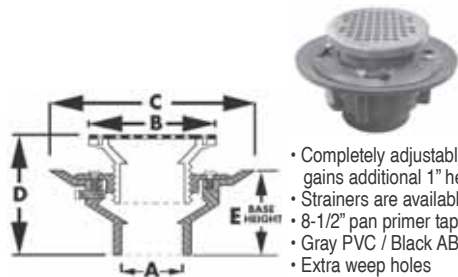

- Completely adjustable; reversible clamping ring gains additional 1" height
- Strainers are available in SS, PB, NB and CP
- 8-1/2" pan primer tapped with 1/2" plug
- Gray PVC / Black ABS
- Extra weep holes

	A	B	C	D	E
Without ring (SS str.)	Over 2" Inside 3"	6-1/4"	8-9/16"	4-13/16" — 6-1/4"	3-3/4"
Without ring	Over 2" Inside 3"	6-1/4"	8-9/16"	4-15/16" — 6-5/16"	3-3/4"
With ring	Over 2" Inside 3"	6-9/16"	8-9/16"	5-1/16" — 6-1/2"	3-3/4"

**PVC**

PART NO.	STRAINER	CTN QTY
D49037	6" SS	1
D49039	6" PB	1
D49041	6" PB with ring	1
D49043	6" NB	1
D49045	6" NB with ring	1
D49047	6" CP	1
D49049	6" CP with ring	1

**ABS**

PART NO.	STRAINER	CTN QTY
D49038	6" SS	1
D49040	6" PB	1
D49042	6" PB with ring	1
D49044	6" NB	1
D49046	6" NB with ring	1
D49048	6" CP	1
D49050	6" CP with ring	1

## 2" x 3" Heavy Duty Drain Base with 3-1/2" Metal Spuds

**4", 5" or 6" Round Strainer**  
Fits Over 2" and Inside 3" Schedule 40 DWV Pipe

MADE IN THE  
**USA**

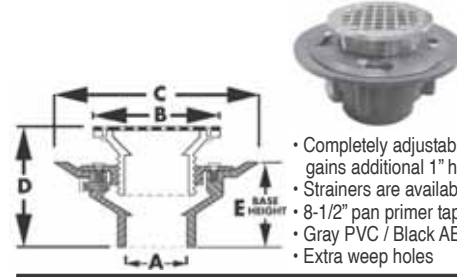

- Completely adjustable; reversible clamping ring gains additional 1" height
- Strainers are available in PB, NB and CP
- 8-1/2" pan primer tapped with 1/2" plug
- Gray PVC / Black ABS
- Extra weep holes

	A	B	C	D	E
4" metal	Over 2" Inside 3"	4-1/8"	8-9/16"	4-1/8" — 5-1/4"	3-3/4"
5" metal	Over 2" Inside 3"	5-3/16"	8-9/16"	4-1/8" — 5-5/16"	3-3/4"
6" metal	Over 2" Inside 3"	6-3/16"	8-9/16"	4-5/16" — 5-3/4"	3-3/4"

**PVC**

PART NO.	STRAINER	CTN QTY
D49051	4" PB	1
D49053	4" NB	1
D49055	5" PB	1
D49057	5" NB	1
D49059	5" CP	1
D49061	6" PB	1
D49063	6" NB	1
D49065	6" CP	1

**ABS**

PART NO.	STRAINER	CTN QTY
D49052	4" PB	1
D49054	4" NB	1
D49056	5" PB	1
D49058	5" NB	1
D49060	5" CP	1
D49062	6" PB	1
D49064	6" NB	1
D49066	6" CP	1

## 2" x 3" Heavy Duty Drain Base with 4" Plastic Spuds

### 6" Round Strainer

Fits Over 2" and Inside 3" Schedule 40 DWV Pipe

MADE IN THE USA

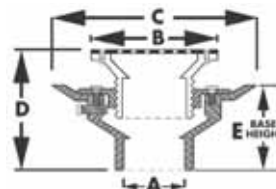

- Completely adjustable; reversible clamping ring gains additional 1" height
- Strainers are available in SS, PB, NB and CP
- 8-1/2" pan primer tapped with 1/2" plug
- Gray PVC / Black ABS
- Extra weep holes

	A	B	C	D	E
Without ring (SS str.)	Over 2" Inside 3"	6-3/16"	8-9/16"	5" - 6-3/16"	3-3/4"
Without ring	Over 2" Inside 3"	6-3/16"	8-9/16"	5-1/16" - 6-1/4"	3-3/4"

PVC

PART NO.	STRAINER	CTN QTY
D49077	6" SS	1
D49079	6" PB	1
D49081	6" PB with ring	1
D49083	6" NB	1
D49085	6" NB with ring	1
D49087	6" CP	1
D49089	6" CP with ring	1

ABS

PART NO.	STRAINER	CTN QTY
D49078	6" SS	1
D49080	6" PB	1
D49082	6" PB with ring	1
D49084	6" NB	1
D49086	6" NB with ring	1
D49088	6" CP	1
D49090	6" CP with ring	1

## 4" Heavy Duty Slab Drain Base with 3" Plastic Spuds

### 6" Round Strainer

Fits Over 4" Schedule 40 DWV Pipe

MADE IN THE USA

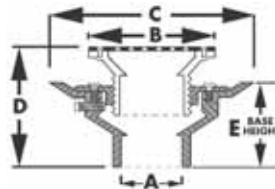

- 8-1/2" pan for applications where no clamping ring is required
- Strainers are available in SS, PB, NB and CP
- Spud threads directly into base
- Primer tapped with 1/2" plug
- Gray PVC / Black ABS
- Completely adjustable

	A	B	C	D	E
Without ring (SS str.)	Over 4"	6-1/8"	8-9/16"	5-5/16" - 6-3/8"	4-3/16"
Without ring	Over 4"	6-1/8"	8-9/16"	5-3/8" - 6-5/16"	4-3/16"
With ring	Over 4"	6-7/16"	8-9/16"	5-1/8" - 6-9/16"	4-3/16"

PVC

PART NO.	STRAINER	CTN QTY
D49501	6" SS	1
D49503	6" PB	1
D49505	6" PB with ring	1
D49507	6" NB	1
D49509	6" NB with ring	1
D49511	6" CP	1
D49513	6" CP with ring	1

ABS

PART NO.	STRAINER	CTN QTY
D49502	6" SS	1
D49504	6" PB	1
D49506	6" PB with ring	1
D49508	6" NB	1
D49510	6" NB with ring	1
D49512	6" CP	1
D49514	6" CP with ring	1

## 2" x 3" Heavy Duty Drain Base with 4" Metal Spuds

### 5" Round Strainer

Fits Over 2" and Inside 3" Schedule 40 DWV Pipe

MADE IN THE USA

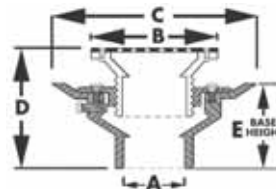

- Completely adjustable; reversible clamping ring gains additional 1" height
- Strainers are available in SS, PB, NB and CP
- 8-1/2" pan primer tapped with 1/2" plug
- Gray PVC / Black ABS
- Extra weep holes

	A	B	C	D	E
Metal	Over 2" Inside 3"	5-3/16"	8-9/16"	4-1/8" - 5-3/16"	3-3/4"

PVC

PART NO.	STRAINER	CTN QTY
D49095	5" PB	1
D49097	5" NB	1

ABS

PART NO.	STRAINER	CTN QTY
D49096	5" PB	1
D49098	5" NB	1

## 4" Heavy Duty Slab Drain Base with 3" Metal Spuds

### 5" Round Strainer

Fits Over 4" Schedule 40 DWV Pipe

MADE IN THE USA

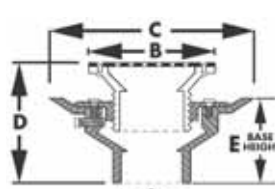

- 8-1/2" pan for applications where no clamping ring is required
- Strainers are available in PB and NB
- Spud threads directly into base
- Primer tapped with 1/2" plug
- Gray PVC / Black ABS
- Completely adjustable

	A	B	C	D	E
Metal	Over 4"	5-3/16"	8-9/16"	4-5/16" - 5-3/8"	4-3/16"

PVC

PART NO.	STRAINER	CTN QTY
D49519	5" PB	1
D49521	5" NB	1

ABS

PART NO.	STRAINER	CTN QTY
D49520	5" PB	1
D49522	5" NB	1

### 4" Heavy Duty Slab Drain Base with 3-1/2" Plastic Spuds

#### 5" Round Strainer

Fits Over 4" Schedule 40 DWV Pipe

MADE IN THE  
**USA**

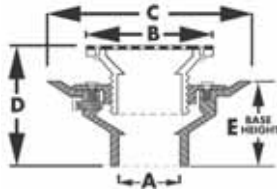

- 8-1/2" pan for applications where no clamping ring is required
- Strainers are available in SS, PB, NB and CP
- Spud threads directly into base
- Primer tapped with 1/2" plug
- Gray PVC / Black ABS
- Completely adjustable

	A	B	C	D	E
Without ring (SS str.)	Over 4"	5-1/4"	8-9/16"	5-1/4" — 6-7/16"	4-3/16"
Without ring	Over 4"	5-1/4"	8-9/16"	5-3/8" — 6-7/16"	4-3/16"
With ring	Over 4"	5-9/16"	8-9/16"	5-9/16" — 6-5/8"	4-3/16"

**PVC**

PART NO.	STRAINER	CTN QTY
D49523	5" SS	1
D49525	5" PB	1
D49527	5" PB with ring	1
D49529	5" NB	1
D49531	5" NB with ring	1
D49533	5" CP	1
D49535	5" CP with ring	1

**ABS**

PART NO.	STRAINER	CTN QTY
D49524	5" SS	1
D49526	5" PB	1
D49528	5" PB with ring	1
D49530	5" NB	1
D49532	5" NB with ring	1
D49534	5" CP	1
D49536	5" CP with ring	1

### 4" Heavy Duty Slab Drain Base with 3-1/2" Plastic Spuds

#### 6" Round Strainer

Fits Over 4" Schedule 40 DWV Pipe

MADE IN THE  
**USA**

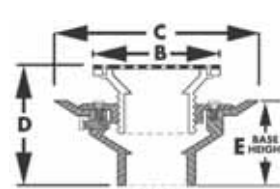

- 8-1/2" pan for applications where no clamping ring is required
- Strainers are available in SS, PB, NB and CP
- Spud threads directly into base
- Primer tapped with 1/2" plug
- Gray PVC / Black ABS
- Completely adjustable

	A	B	C	D	E
Without ring (SS str.)	Over 4"	6-1/4"	8-9/16"	5-3/8" — 6-7/16"	4-3/16"
Without ring	Over 4"	6-1/4"	8-9/16"	5-7/16" — 6-7/16"	4-3/16"
With ring	Over 4"	6-9/16"	8-9/16"	5-1/2" — 6-5/8"	4-3/16"

**PVC**

PART NO.	STRAINER	CTN QTY
D49537	6" SS	1
D49539	6" PB	1
D49541	6" PB with ring	1
D49543	6" NB	1
D49545	6" NB with ring	1
D49547	6" CP	1
D49549	6" CP with ring	1

**ABS**

PART NO.	STRAINER	CTN QTY
D49538	6" SS	1
D49540	6" PB	1
D49542	6" PB with ring	1
D49544	6" NB	1
D49546	6" NB with ring	1
D49548	6" CP	1
D49550	6" CP with ring	1

### 4" Heavy Duty Slab Drain Base with 3-1/2" Metal Spuds

#### 4", 5" or 6" Round Strainer

Fits Over 4" Schedule 40 DWV Pipe



MADE IN THE USA

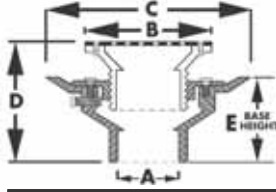

- 8-1/2" pan for applications where no clamping ring is required
- Strainers are available in PB, NB and CP
- Spud threads directly into base
- Primer tapped with 1/2" plug
- Gray PVC / Black ABS
- Completely adjustable

	A	B	C	D	E
4" metal	Over 4"	4-1/8"	8-9/16"	4-7/16" – 5-7/16"	4-3/16"
5" metal	Over 4"	5-3/16"	8-9/16"	4-5/16" – 5-7/16"	4-3/16"
6" metal	Over 4"	6-3/16"	8-9/16"	4-13/16" – 5-13/16"	4-3/16"

PVC

PART NO.	STRAINER	CTN QTY
D49551	4" PB	1
D49553	4" NB	1
D49555	5" PB	1
D49557	5" NB	1
D49559	5" CP	1
D49561	6" PB	1
D49563	6" NB	1
D49565	6" CP	1

ABS

PART NO.	STRAINER	CTN QTY
D49552	4" PB	1
D49554	4" NB	1
D49556	5" PB	1
D49558	5" NB	1
D49560	5" CP	1
D49562	6" PB	1
D49564	6" NB	1
D49566	6" CP	1

### 4" Heavy Duty Slab Drain Base with 4" Plastic Spuds

#### 6" Round Strainer

Fits Over 4" Schedule 40 DWV Pipe



MADE IN THE USA

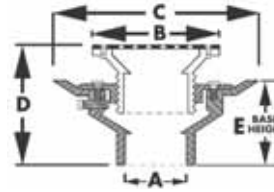

- 8-1/2" pan for applications where no clamping ring is required
- Strainers are available in SS, PB, NB and CP
- Spud threads directly into base
- Primer tapped with 1/2" plug
- Gray PVC / Black ABS
- Completely adjustable

	A	B	C	D	E
Without ring (SS str.)	Over 4"	6-3/16"	8-9/16"	5-3/8" – 6-3/8"	4-3/16"
Without ring	Over 4"	6-3/16"	8-9/16"	5-7/16" – 6-7/16"	4-3/16"
With ring	Over 4"	6-7/16"	8-9/16"	5-5/8" – 6-9/16"	4-3/16"

PVC

PART NO.	STRAINER	CTN QTY
D49577	6" SS	1
D49579	6" PB	1
D49581	6" PB with ring	1
D49583	6" NB	1
D49585	6" NB with ring	1
D49587	6" CP	1
D49589	6" CP with ring	1

ABS

PART NO.	STRAINER	CTN QTY
D49578	6" SS	1
D49580	6" PB	1
D49582	6" PB with ring	1
D49584	6" NB	1
D49586	6" NB with ring	1
D49588	6" CP	1
D49590	6" CP with ring	1

### 4" Heavy Duty Slab Drain Base with 4" Metal Spuds

#### 5" Round Strainer

Fits Over 4" Schedule 40 DWV Pipe



MADE IN THE USA

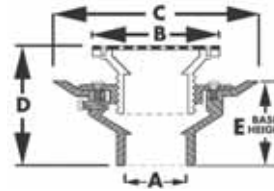

- 8-1/2" pan for applications where no clamping ring is required
- Strainers are available in PB and NB
- Spud threads directly into base
- Primer tapped with 1/2" plug
- Gray PVC / Black ABS
- Completely adjustable

	A	B	C	D	E
Metal	Over 4"	5-3/16"	8-9/16"	4-1/4" – 5-5/16"	4-3/16"

PVC

PART NO.	STRAINER	CTN QTY
D49595	5" PB	1
D49597	5" NB	1

ABS

PART NO.	STRAINER	CTN QTY
D49596	5" PB	1
D49598	5" NB	1

### 3" x 4" Heavy Duty Slab Drain Base with 3" Plastic Spuds

#### 6" Round Strainer

Fits Over 3" and Inside 4" Schedule 40 DWV Pipe

MADE IN THE USA

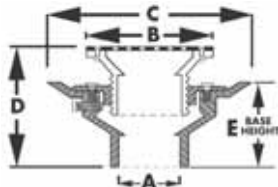

- 8-1/2" pan for applications where no clamping ring is required
- Strainers are available in SS, PB, NB and CP
- Spud threads directly into base
- Primer tapped with 1/2" plug
- Gray PVC / Black ABS
- Completely adjustable

	A	B	C	D	E
Without ring (SS str.)	Over 3" Inside 4"	6-1/8"	8-9/16"	5-1/16" – 6-1/16"	3-3/4"
Without ring	Over 3" Inside 4"	6-1/8"	8-9/16"	5-1/8" – 6-3/16"	3-3/4"
With ring	Over 3" Inside 4"	6-7/16"	8-9/16"	5-5/16" – 6-3/8"	3-3/4"

PVC

PART NO.	STRAINER	CTN QTY
D49401	6" SS	1
D49403	6" PB	1
D49405	6" PB with ring	1
D49407	6" NB	1
D49409	6" NB with ring	1
D49411	6" CP	1
D49413	6" CP with ring	1

ABS

PART NO.	STRAINER	CTN QTY
D49402	6" SS	1
D49404	6" PB	1
D49406	6" PB with ring	1
D49408	6" NB	1
D49410	6" NB with ring	1
D49412	6" CP	1
D49414	6" CP with ring	1

### 3" x 4" Heavy Duty Slab Drain Base with 3" Metal Spuds

#### 5" Round Strainer

Fits Over 3" and Inside 4" Schedule 40 DWV Pipe

MADE IN THE USA

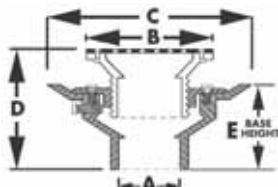

- 8-1/2" pan for applications where no clamping ring is required
- Strainers are available in PB and NB
- Spud threads directly into base
- Primer tapped with 1/2" plug
- Gray PVC / Black ABS
- Completely adjustable

	A	B	C	D	E
Metal	Over 3" Inside 4"	5-3/16"	8-9/16"	4-1/8" – 5-1/8"	3-3/4"

PVC

PART NO.	STRAINER	CTN QTY
D49419	5" PB	1
D49421	5" NB	1

ABS

PART NO.	STRAINER	CTN QTY
D49420	5" PB	1
D49422	5" NB	1

### 3" x 4" Heavy Duty Slab Drain Base with 3-1/2" Plastic Spuds

#### 5" Round Strainer

Fits Over 3" and Inside 4" Schedule 40 DWV Pipe

MADE IN THE USA

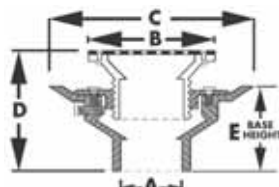

- 8-1/2" pan for applications where no clamping ring is required
- Strainers are available in SS, PB, NB and CP
- Spud threads directly into base
- Primer tapped with 1/2" plug
- Gray PVC / Black ABS
- Completely adjustable

	A	B	C	D	E
Without ring (SS str.)	Over 3" Inside 4"	5-1/4"	8-9/16"	5" – 6-1/8"	3-3/4"
Without ring	Over 3" Inside 4"	5-1/4"	8-9/16"	5-3/16" – 6-3/16"	3-3/4"
With ring	Over 3" Inside 4"	5-9/16"	8-9/16"	5-3/8" – 6-5/16"	3-3/4"

PVC

PART NO.	STRAINER	CTN QTY
D49423	5" SS	1
D49425	5" PB	1
D49427	5" PB with ring	1
D49429	5" NB	1
D49431	5" NB with ring	1
D49433	5" CP	1
D49435	5" CP with ring	1

ABS

PART NO.	STRAINER	CTN QTY
D49424	5" SS	1
D49426	5" PB	1
D49428	5" PB with ring	1
D49430	5" NB	1
D49432	5" NB with ring	1
D49434	5" CP	1
D49436	5" CP with ring	1

**3" x 4" Heavy Duty Slab Drain Base with 3-1/2" Plastic Spuds**

**6" Round Strainer**

Fits Over 3" and Inside 4" Schedule 40 DWV Pipe

MADE IN THE USA

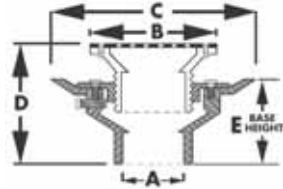

- 8-1/2" pan for applications where no clamping ring is required
- Strainers are available in SS, PB, NB and CP
- Spud threads directly into base
- Primer tapped with 1/2" plug
- Gray PVC / Black ABS
- Completely adjustable

	A	B	C	D	E
Without ring (SS str.)	Over 3" Inside 4"	6-1/4"	8-9/16"	5-1/16" — 6-1/16"	3-3/4"
Without ring	Over 3" Inside 4"	6-1/4"	8-9/16"	5-3/16" — 6-3/16"	3-3/4"
With ring	Over 3" Inside 4"	6-9/16"	8-9/16"	5-5/16" — 6-3/8"	3-3/4"

**PVC**

PART NO.	STRAINER	CTN QTY
D49437	6" SS	1
D49439	6" PB	1
D49441	6" PB with ring	1
D49443	6" NB	1
D49445	6" NB with ring	1
D49447	6" CP	1
D49449	6" CP with ring	1

**ABS**

PART NO.	STRAINER	CTN QTY
D49438	6" SS	1
D49440	6" PB	1
D49442	6" PB with ring	1
D49444	6" NB	1
D49446	6" NB with ring	1
D49448	6" CP	1
D49450	6" CP with ring	1

**3" x 4" Heavy Duty Slab Drain Base with 3-1/2" Metal Spuds**

**4", 5", 6", 8" or 9" Round Strainer**

Fits Over 3" and Inside 4" Schedule 40 DWV Pipe

MADE IN THE USA

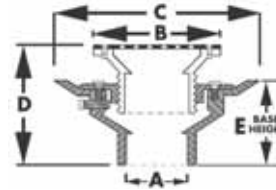

- 8-1/2" pan for applications where no clamping ring is required
- Strainers are available in PB, NB and CP
- Spud threads directly into base
- Primer tapped with 1/2" plug
- Gray PVC / Black ABS
- Completely adjustable

	A	B	C	D	E
4" round	Over 3" Inside 4"	4-1/8"	8-9/16"	4-1/8" — 5-1/16"	3-15/16"
5" round	Over 3" Inside 4"	5-3/16"	8-9/16"	4-1/8" — 5-1/4"	3-15/16"
6" round	Over 3" Inside 4"	6-3/16"	8-9/16"	4-9/16" — 5-7/16"	3-15/16"
8" round	Over 3" Inside 4"	8-1/8"	8-9/16"	5-1/16" — 6"	3-15/16"
9" round	Over 3" Inside 4"	9"	8-9/16"	5" — 6-1/8"	3-15/16"

**PVC**

PART NO.	STRAINER	CTN QTY
D49451	4" PB	1
D49453	4" NB	1
D49455	5" PB	1
D49457	5" NB	1
D49459	5" CP	1
D49461	6" PB	1
D49463	6" NB	1
D49465	6" CP	1
D49467	8" PB	1
D49469	8" NB	1
D49471	8" CP	1
D49473	9" PB	1
D49475	9" NB	1

**ABS**

PART NO.	STRAINER	CTN QTY
D49452	4" PB	1
D49454	4" NB	1
D49456	5" PB	1
D49458	5" NB	1
D49460	5" CP	1
D49462	6" PB	1
D49464	6" NB	1
D49466	6" CP	1
D49468	8" PB	1
D49470	8" NB	1
D49472	8" CP	1
D49474	9" PB	1
D49476	9" NB	1

### 3" x 4" Heavy Duty Slab Drain Base with 4" Plastic Spuds

#### 6" Round Strainer

Fits Over 3" and Inside 4" Schedule 40 DWV Pipe

MADE IN THE  
**USA**

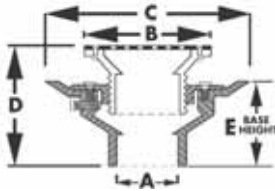

- 8-1/2" pan for applications where no clamping ring is required
- Strainers are available in SS, PB, NB and CP
- Spud threads directly into base
- Primer tapped with 1/2" plug
- Gray PVC / Black ABS
- Completely adjustable

	A	B	C	D	E
Without ring (SS str.)	Over 3" Inside 4"	6-3/16"	8-9/16"	5-1/16" — 6-1/8"	3-15/16"
Without ring	Over 3" Inside 4"	6-3/16"	8-9/16"	5-1/4" — 6-3/16"	3-15/16"
With ring	Over 3" Inside 4"	6-7/16"	8-9/16"	5-3/8" — 6-5/16"	3-15/16"

#### PVC

PART NO.	STRAINER	CTN QTY
D49477	6" SS	1
D49479	6" PB	1
D49481	6" PB with ring	1
D49483	6" NB	1
D49485	6" NB with ring	1
D49487	6" CP	1
D49489	6" CP with ring	1

#### ABS

PART NO.	STRAINER	CTN QTY
D49478	6" SS	1
D49480	6" PB	1
D49482	6" PB with ring	1
D49484	6" NB	1
D49486	6" NB with ring	1
D49488	6" CP	1
D49490	6" CP with ring	1

### 3" x 4" Heavy Duty Slab Drain Base with 4" Metal Spuds

#### 5" Round Strainer

Fits Over 3" and Inside 4" Schedule 40 DWV Pipe

MADE IN THE  
**USA**

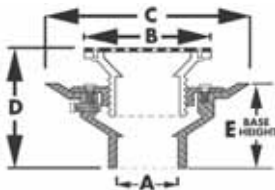

- 8-1/2" pan for applications where no clamping ring is required
- Strainers are available in PB and NB
- Spud threads directly into base
- Primer tapped with 1/2" plug
- Gray PVC / Black ABS
- Completely adjustable

	A	B	C	D	E
Metal	Over 3" Inside 4"	5-3/16"	8-9/16"	4" — 5-1/8"	3-15/16"

#### PVC

PART NO.	STRAINER	CTN QTY
D49495	5" PB	1
D49497	5" NB	1

#### ABS

PART NO.	STRAINER	CTN QTY
D49496	5" PB	1
D49498	5" NB	1

### 2" x 3" Heavy Duty Slab Drain Base with 3" Plastic Spuds

#### 6" Round Strainer

Fits Over 2" and Inside 3" Schedule 40 DWV Pipe

MADE IN THE  
**USA**

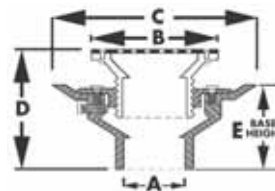

- 8-1/2" pan for applications where no clamping ring is required
- Strainers are available in SS, PB, NB and CP
- Spud threads directly into base
- Primer tapped with 1/2" plug
- Gray PVC / Black ABS
- Completely adjustable

	A	B	C	D	E
Without ring (SS str.)	Over 2" Inside 3"	6-1/8"	8-9/16"	4-15/16" — 5-7/8"	3-3/4"
Without ring	Over 2" Inside 3"	6-1/8"	8-9/16"	5" — 6"	3-3/4"
With ring	Over 2" Inside 3"	6-7/16"	8-9/16"	5-1/8" — 6-1/8"	3-3/4"

#### PVC

PART NO.	STRAINER	CTN QTY
D49301	6" SS	1
D49303	6" PB	1
D49305	6" PB with ring	1
D49307	6" NB	1
D49309	6" NB with ring	1
D49311	6" CP	1
D49313	6" CP with ring	1

#### ABS

PART NO.	STRAINER	CTN QTY
D49302	6" SS	1
D49304	6" PB	1
D49306	6" PB with ring	1
D49308	6" NB	1
D49310	6" NB with ring	1
D49312	6" CP	1
D49314	6" CP with ring	1

### 2" x 3" Heavy Duty Slab Drain Base with 3" Metal Spuds

#### 5" Round Strainer

Fits Over 2" and Inside 3" Schedule 40 DWV Pipe

MADE IN THE  
**USA**

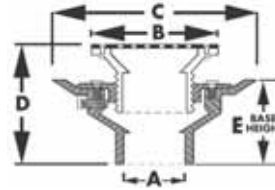

- 8-1/2" pan for applications where no clamping ring is required
- Strainers are available in PB and NB
- Spud threads directly into base
- Primer tapped with 1/2" plug
- Gray PVC / Black ABS
- Completely adjustable

	A	B	C	D	E
Metal	Over 2" Inside 3"	5-3/16"	8-9/16"	3-15/16" — 4-15/16"	3-3/4"

#### PVC

PART NO.	STRAINER	CTN QTY
D49319	5" PB	1
D49321	5" NB	1

#### ABS

PART NO.	STRAINER	CTN QTY
D49320	5" PB	1
D49322	5" NB	1

**2" x 3" Heavy Duty Slab Drain Base with 3-1/2" Plastic Spuds**

**5" Round Strainer**

Fits Over 2" and Inside 3" Schedule 40 DWV Pipe

MADE IN THE  
**USA**

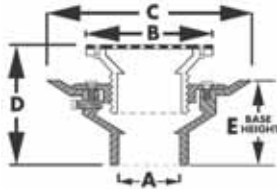

- 8-1/2" pan for applications where no clamping ring is required
- Strainers are available in SS, PB, NB and CP
- Spud threads directly into base
- Primer tapped with 1/2" plug
- Gray PVC / Black ABS
- Completely adjustable

	A	B	C	D	E
Without ring (SS str.)	Over 2" Inside 3"	5-1/4"	8-9/16"	4-3/4" — 6-1/16"	3-3/4"
Without ring	Over 2" Inside 3"	5-1/4"	8-9/16"	5" — 5-15/16"	3-3/4"
With ring	Over 2" Inside 3"	5-9/16"	8-9/16"	5-1/8" — 6-1/8"	3-3/4"

PVC

PART NO.	STRAINER	CTN QTY
D49323	5" SS	1
D49325	5" PB	1
D49327	5" PB with ring	1
D49329	5" NB	1
D49331	5" NB with ring	1
D49333	5" CP	1
D49335	5" CP with ring	1

ABS

PART NO.	STRAINER	CTN QTY
D49324	5" SS	1
D49326	5" PB	1
D49328	5" PB with ring	1
D49330	5" NB	1
D49332	5" NB with ring	1
D49334	5" CP	1
D49336	5" CP with ring	1

**2" x 3" Heavy Duty Slab Drain Base with 3-1/2" Plastic Spuds**

**6" Round Strainer**

Fits Over 2" and Inside 3" Schedule 40 DWV Pipe

MADE IN THE  
**USA**

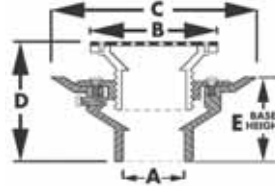

- 8-1/2" pan for applications where no clamping ring is required
- Strainers are available in SS, PB, NB and CP
- Spud threads directly into base
- Primer tapped with 1/2" plug
- Gray PVC / Black ABS
- Completely adjustable

	A	B	C	D	E
Without ring (SS str.)	Over 2" Inside 3"	6-1/4"	8-9/16"	5" — 6-1/16"	3-3/4"
Without ring	Over 2" Inside 3"	6-1/4"	8-9/16"	5-1/8" — 6"	3-3/4"
With ring	Over 2" Inside 3"	6-9/16"	8-9/16"	5-1/4" — 6-1/4"	3-3/4"

PVC

PART NO.	STRAINER	CTN QTY
D49337	6" SS	1
D49339	6" PB	1
D49341	6" PB with ring	1
D49343	6" NB	1
D49345	6" NB with ring	1
D49347	6" CP	1
D49349	6" CP with ring	1

ABS

PART NO.	STRAINER	CTN QTY
D49338	6" SS	1
D49340	6" PB	1
D49342	6" PB with ring	1
D49344	6" NB	1
D49346	6" NB with ring	1
D49348	6" CP	1
D49350	6" CP with ring	1

## 2" x 3" Heavy Duty Slab Drain Base with 3-1/2" Metal Spuds

### 4", 5" or 6" Round Strainer

Fits Over 2" and Inside 3" Schedule 40 DWV Pipe

MADE IN THE  
**USA**

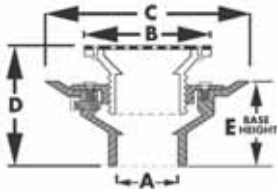

- 8-1/2" pan for applications where no clamping ring is required
- Strainers are available in PB, NB and CP
- Spud threads directly into base
- Primer tapped with 1/2" plug
- Gray PVC / Black ABS
- Completely adjustable

	A	B	C	D	E
4" without ring	Over 2" Inside 3"	4-1/8"	8-9/16"	4 7/8" — 4-15/16"	3-3/4"
5" without ring	Over 2" Inside 3"	5-3/16"	8-9/16"	4" — 5"	3-3/4"
6" without ring	Over 2" Inside 3"	6-3/16"	8-9/16"	4-7/16" — 5-1/2"	3-3/4"

#### PVC

PART NO.	STRAINER	CTN QTY
D49351	4" PB	1
D49353	4" NB	1
D49355	5" PB	1
D49357	5" NB	1
D49359	5" CP	1
D49361	6" PB	1
D49363	6" NB	1
D49365	6" CP	1

#### ABS

PART NO.	STRAINER	CTN QTY
D49352	4" PB	1
D49354	4" NB	1
D49356	5" PB	1
D49358	5" NB	1
D49360	5" CP	1
D49362	6" PB	1
D49364	6" NB	1
D49366	6" CP	1

## 2" x 3" Heavy Duty Slab Drain Base with 4" Plastic Spuds

### 6" Round Strainer

Fits Over 2" and Inside 3" Schedule 40 DWV Pipe

MADE IN THE  
**USA**

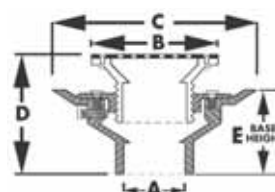

- 8-1/2" pan for applications where no clamping ring is required
- Strainers are available in SS, PB, NB and CP
- Spud threads directly into base
- Primer tapped with 1/2" plug
- Gray PVC / Black ABS
- Completely adjustable

	A	B	C	D	E
Without ring (SS str.)	Over 2" Inside 3"	6-3/16"	8-9/16"	5" — 5-15/16"	3-3/4"
Without ring	Over 2" Inside 3"	6-3/16"	8-9/16"	5" — 6"	3-3/4"
With ring	Over 2" Inside 3"	6-7/16"	8-9/16"	5-3/16" — 6-3/16"	3-3/4"

#### PVC

PART NO.	STRAINER	CTN QTY
D49377	6" SS	1
D49379	6" PB	1
D49381	6" PB with ring	1
D49383	6" NB	1
D49385	6" NB with ring	1
D49387	6" CP	1
D49389	6" CP with ring	1

#### ABS

PART NO.	STRAINER	CTN QTY
D49378	6" SS	1
D49380	6" PB	1
D49382	6" PB with ring	1
D49384	6" NB	1
D49386	6" NB with ring	1
D49388	6" CP	1
D49390	6" CP with ring	1

## 2" x 3" Heavy Duty Slab Drain Base with 4" Metal Spuds

### 5" Round Strainer

Fits Over 2" and Inside 3" Schedule 40 DWV Pipe

MADE IN THE  
**USA**

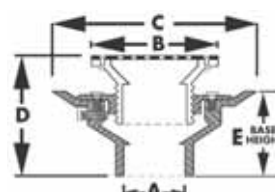

- 8-1/2" pan for applications where no clamping ring is required
- Strainers are available in PB and NB
- Spud threads directly into base
- Primer tapped with 1/2" plug
- Gray PVC / Black ABS
- Completely adjustable

	A	B	C	D	E
Metal	Over 2" Inside 3"	5-3/16"	8-9/16"	3-7/8" — 4-7/8"	3-3/4"

#### PVC

PART NO.	STRAINER	CTN QTY
D49395	5" PB	1
D49397	5" NB	1

#### ABS

PART NO.	STRAINER	CTN QTY
D49396	5" PB	1
D49398	5" NB	1

## 2" Heavy Duty Drain Base with 3-1/2" Plastic Spuds

### 5" Round Strainer

Fits Over 2" Schedule 40 DWV Pipe



MADE IN THE  
**USA**

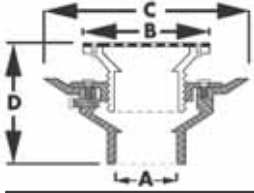

- 10" Pan
- Stainless steel strainers are .06" thick
- PB, NB and CP strainers are 3/16" thick
- Strainers are available in SS, PB, NB and CP
- Primer tapped with 1/2" plug

	A	B	C	D
Without ring	Over 2"	5-3/16"	11"	4-3/8" – 6"
With ring	Over 2"	5-1/2"	11"	4-1/2" – 6-1/8"

**PVC**

PART NO.	STRAINER	CTN QTY
D53442	5" SS	1
D53443	5" PB	1
D53444	5" PB with ring	1
D53445	5" NB	1
D53446	5" NB with ring	1
D53447	5" CP	1
D53448	5" CP with ring	1

**ABS**

PART NO.	STRAINER	CTN QTY
D53449	5" SS	1
D53450	5" PB	1
D53451	5" PB with ring	1
D53452	5" NB	1
D53453	5" NB with ring	1
D53454	5" CP	1
D53455	5" CP with ring	1

## 2" Heavy Duty Drain Base with 3-1/2" Plastic Spuds

### 6" Round Strainer

Fits Over 2" Schedule 40 DWV Pipe



MADE IN THE  
**USA**

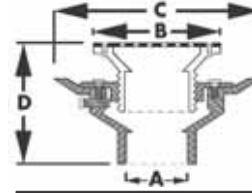

- 10" Pan
- Stainless steel strainers are .06" thick
- PB, NB and CP strainers are 3/16" thick
- Strainers are available in SS, PB, NB and CP
- Primer tapped with 1/2" plug
- Adjustable (see dimension D)

	A	B	C	D
Without ring	Over 2"	6-1/8"	11"	4-7/16" – 6-1/16"
With ring	Over 2"	6-1/2"	11"	4-1/2" – 6-1/4"

**PVC**

PART NO.	STRAINER	CTN QTY
D50037	6" SS	1
D50044	6" PB	1
D50050	6" PB with ring	1
D50047	6" NB	1
D50053	6" NB with ring	1
D50040	6" CP	1
D50278	6" CP with ring	1

**ABS**

PART NO.	STRAINER	CTN QTY
D51037	6" SS	1
D51044	6" PB	1
D51050	6" PB with ring	1
D51047	6" NB	1
D51053	6" NB with ring	1
D51040	6" CP	1
D51278	6" CP with ring	1

## 2" Heavy Duty Drain Base with 3-1/2" Metal Spuds

**5" or 6" Round Strainer**  
Fits Over 2" Schedule 40 DWV Pipe



- 10" Pan
- PB, NB and CP strainers are 3/16" thick
- Strainers are available in PB, NB and CP
- Primer tapped with 1/2" plug
- Adjustable (see dimension D)

	A	B	C	D
Metal	Over 2"	5" or 6"	11"	4-1/4" — 5-5/8"

**PVC**

PART NO.	STRAINER	CTN QTY
D50027	5" PB	1
D50060	5" NB	1
D50022	5" CP	1
D50028	6" PB	1
D50063	6" NB	1
D50023	6" CP	1

**ABS**

PART NO.	STRAINER	CTN QTY
D51027	5" PB	1
D51060	5" NB	1
D51022	5" CP	1
D51028	6" PB	1
D51063	6" NB	1
D51023	6" CP	1

## 2" Heavy Duty Drain Base with 3-1/2" Metal Spuds

**5" or 6" Square Strainer**  
Fits Over 2" Schedule 40 DWV Pipe



- 10" Pan
- Strainers are available in PB and NB
- PB and NB strainers are 3/16" thick
- Primer tapped with 1/2" plug

	A	B	C	D
Square top	Over 2"	5" or 6"	11"	4-1/4" — 5-5/8"

**PVC**

PART NO.	STRAINER	CTN QTY
D50066	5" PB	1
D50072	5" NB	1
D50069	6" PB	1
D50075	6" NB	1

**ABS**

PART NO.	STRAINER	CTN QTY
D51066	5" PB	1
D51072	5" NB	1
D51069	6" PB	1
D51075	6" NB	1

## 3" Heavy Duty Drain Base with 3-1/2" Plastic Spuds

**5" Round Strainer**  
Fits Over 3" Schedule 40 DWV Pipe



- 10" Pan
- Stainless steel strainers are .06" thick
- PB, NB and CP strainers are 3/16" thick
- Strainers are available in SS, PB, NB and CP
- Primer tapped with 1/2" plug

	A	B	C	D
Without ring	Over 3"	5-3/16"	11"	4-3/8" — 6"
With ring	Over 3"	5-1/2"	11"	4-1/2" — 6-1/8"

**PVC**

PART NO.	STRAINER	CTN QTY
D53456	5" SS	1
D53457	5" PB	1
D53458	5" PB with ring	1
D53459	5" NB	1
D53460	5" NB with ring	1
D53461	5" CP	1
D53462	5" CP with ring	1

**ABS**

PART NO.	STRAINER	CTN QTY
D53463	5" SS	1
D53464	5" PB	1
D53465	5" PB with ring	1
D53466	5" NB	1
D53467	5" NB with ring	1
D53468	5" CP	1
D53469	5" CP with ring	1

### 3" Heavy Duty Drain Base with 3-1/2" Plastic Spuds

#### 6" Round Strainer

Fits Over 3" Schedule 40 DWV Pipe



MADE IN THE  
**USA**

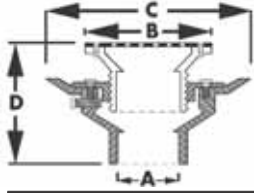

- 10" Pan
- Stainless steel strainers are .06" thick
- PB, NB and CP strainers are 3/16" thick
- Strainers are available in SS, PB, NB and CP
- Primer tapped with 1/2" plug

	A	B	C	D
Without ring	Over 3"	6-1/8"	11"	4-11/16" – 6-7/16"
With ring	Over 3"	6-1/2"	11"	4-3/4" – 6-1/2"

**PVC**

PART NO.	STRAINER	CTN QTY
D50038	6" SS	1
D50045	6" PB	1
D50051	6" PB with ring	1
D50048	6" NB	1
D50054	6" NB with ring	1
D50041	6" CP	1
D50279	6" CP with ring	1

**ABS**

PART NO.	STRAINER	CTN QTY
D51038	6" SS	1
D51045	6" PB	1
D51051	6" PB with ring	1
D51048	6" NB	1
D51054	6" NB with ring	1
D51041	6" CP	1
D51279	6" CP with ring	1

### 3" Heavy Duty Drain Base with 3-1/2" Metal Spuds

#### 5", 6", 8" or 9" Round Strainer

Fits Over 3" Schedule 40 DWV Pipe



MADE IN THE  
**USA**

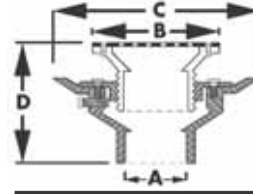

- 10" Pan
- Stainless steel strainers are .06" thick
- PB, NB and CP strainers are 3/16" thick
- Strainers are available in PB, NB and CP
- Primer tapped with 1/2" plug

	A	B	C	D
Metal	Over 3"	5", 6", 8" or 9"	11"	5" – 6-1/2"

**PVC**

PART NO.	STRAINER	CTN QTY
D50012	5" PB	1
D50061	5" NB	1
D50004	5" CP	1
D50013	6" PB	1
D50064	6" NB	1
D50005	6" CP	1
D50014	8" PB	1
D53144	8" NB	1
D50006	8" CP	1
D53148	9" PB	1
D53146	9" NB	1

**ABS**

PART NO.	STRAINER	CTN QTY
D51012	5" PB	1
D51061	5" NB	1
D51004	5" CP	1
D51013	6" PB	1
D51064	6" NB	1
D51005	6" CP	1
D51014	8" PB	1
D53145	8" NB	1
D51006	8" CP	1
D53149	9" PB	1
D53147	9" NB	1

### 3" Heavy Duty Drain Base with 3-1/2" Metal Spuds

**5" or 6" Square Strainer**  
Fits Over 3" Schedule 40 DWV Pipe



- 10" Pan
- Strainers are available in PB and NB
- PB and NB strainers are 3/16" thick
- Primer tapped with 1/2" plug

	A	B	C	D
Square top	Over 3"	5" or 6"	11"	5" - 6-1/2"

PVC

PART NO.	STRAINER	CTN QTY
D50067	5" PB	1
D50073	5" NB	1
D50070	6" PB	1
D50076	6" NB	1

ABS

PART NO.	STRAINER	CTN QTY
D51067	5" PB	1
D51073	5" NB	1
D51070	6" PB	1
D51076	6" NB	1

### 4" Heavy Duty Drain Base with 3-1/2" Plastic Spuds

**5" Round Strainer**  
Fits Over 4" Schedule 40 DWV Pipe



- 10" Pan
- Stainless steel strainers are .06" thick
- PB, NB and CP strainers are 3/16" thick
- Strainers are available in SS, PB, NB and CP
- Primer tapped with 1/2" plug

	A	B	C	D
Without ring	Over 4"	5-3/16"	11"	4-3/8" - 6"
With ring	Over 4"	5-1/2"	11"	4-1/2" - 6-1/8"

PVC

PART NO.	STRAINER	CTN QTY
D53470	5" SS	1
D53471	5" PB	1
D53472	5" PB with ring	1
D53473	5" NB	1
D53474	5" NB with ring	1
D53475	5" CP	1
D53476	5" CP with ring	1

ABS

PART NO.	STRAINER	CTN QTY
D53477	5" SS	1
D53478	5" PB	1
D53479	5" PB with ring	1
D53480	5" NB	1
D53481	5" NB with ring	1
D53482	5" CP	1
D53483	5" CP with ring	1

### 4" Heavy Duty Drain Base with 3-1/2" Plastic Spuds

**6" Round Strainer**  
Fits Over 4" Schedule 40 DWV Pipe



- 10" Pan
- Stainless steel strainers are .06" thick
- PB, NB and CP strainers are 3/16" thick
- Strainers are available in SS, PB, NB and CP
- Primer tapped with 1/2" plug

	A	B	C	D
Without ring	Over 4"	6-1/8"	11"	5-1/16" - 6-13/16"
With ring	Over 4"	6-1/2"	11"	5-1/4" - 6-15/16"

PVC

PART NO.	STRAINER	CTN QTY
D50039	6" SS	1
D50046	6" PB	1
D50052	6" PB with ring	1
D50049	6" NB	1
D50055	6" NB with ring	1
D50042	6" CP	1
D50280	6" CP with ring	1

ABS

PART NO.	STRAINER	CTN QTY
D51039	6" SS	1
D51046	6" PB	1
D51052	6" PB with ring	1
D51049	6" NB	1
D51055	6" NB with ring	1
D51042	6" CP	1
D51280	6" CP with ring	1

### 4" Heavy Duty Drain Base with 3-1/2" Metal Spuds

#### 5" or 6" Round Strainer

Fits Over 4" Schedule 40 DWV Pipe



MADE IN THE USA

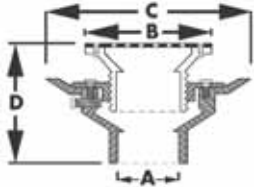

- 10" Pan
- Stainless steel strainers are .06" thick
- PB, NB and CP strainers are 3/16" thick
- Strainers are available in PB, NB and CP
- Primer tapped with 1/2" plug

	A	B	C	D
Metal	Over 4"	5" or 6"	11"	4-5/8" – 5-7/8"

PVC

PART NO.	STRAINER	CTN QTY
D50062	5" NB	1
D50015	5" PB	1
D50007	5" CP	1
D50065	6" NB	1
D50016	6" PB	1
D50008	6" CP	1

ABS

PART NO.	STRAINER	CTN QTY
D51062	5" NB	1
D51015	5" PB	1
D51007	5" CP	1
D51065	6" NB	1
D51016	6" PB	1
D51008	6" CP	1

### 4" Heavy Duty Drain Base with 3-1/2" Metal Spuds

#### 5" or 6" Square Strainer

Fits Over 4" Schedule 40 DWV Pipe



MADE IN THE USA

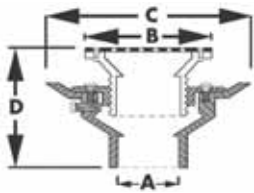

- 10" Pan
- Strainers are available in PB and NB
- PB and NB strainers are 3/16" thick
- Primer tapped with 1/2" plug

	A	B	C	D
Square top	Over 4"	5" or 6"	11"	4-5/8" – 5-7/8"

PVC

PART NO.	STRAINER	CTN QTY
D50068	5" PB	1
D50074	5" NB	1
D50071	6" PB	1
D50077	6" NB	1

ABS

PART NO.	STRAINER	CTN QTY
D51068	5" PB	1
D51074	5" NB	1
D51071	6" PB	1
D51077	6" NB	1

### 2" Heavy Duty Drain Base with 4" Plastic Spuds

#### 6" Round Strainer

Fits Over 2" Schedule 40 DWV Pipe



MADE IN THE USA

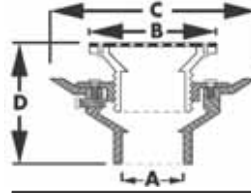

- 10" Pan
- Stainless steel strainers are .06" thick
- PB, NB and CP strainers are 3/16" thick
- Strainers are available in SS, PB, NB and CP
- Primer tapped with 1/2" plug

	A	B	C	D
Without ring	Over 2"	6-1/8"	11"	4-7/16" – 6-1/16"
With ring	Over 2"	6-1/2"	11"	4-1/2" – 6-1/4"

PVC

PART NO.	STRAINER	CTN QTY
D50340	6" SS	1
D50341	6" PB	1
D50342	6" PB with ring	1
D50343	6" NB	1
D50344	6" NB with ring	1
D50345	6" CP	1
D50346	6" CP with ring	1

ABS

PART NO.	STRAINER	CTN QTY
D51340	6" SS	1
D51341	6" PB	1
D51342	6" PB with ring	1
D51343	6" NB	1
D51344	6" NB with ring	1
D51345	6" CP	1
D51346	6" CP with ring	1

### 2" Heavy Duty Drain Base with 4" Metal Spuds

#### 5" Round Strainer

Fits Over 2" Schedule 40 DWV Pipe



MADE IN THE USA

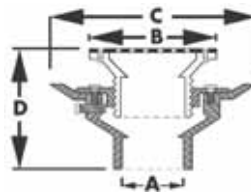

- 10" Pan
- Stainless steel strainers are .06" thick
- Strainers are 3/16" thick
- Strainers are available in PB and NB
- Primer tapped with 1/2" plug

	A	B	C	D
Metal	Over 2"	5"	11"	4-1/4" – 5-5/8"

PVC

PART NO.	STRAINER	CTN QTY
D50349	5" NB	1
D50350	5" PB	1

ABS

PART NO.	STRAINER	CTN QTY
D51349	5" NB	1
D51350	5" PB	1

### 3" Heavy Duty Drain Base with 4" Plastic Spuds

**6" Round Strainer**  
Fits Over 3" Schedule 40 DWV Pipe



- 10" Pan
- Stainless steel strainers are .06" thick
- PB, NB and CP strainers are 3/16" thick
- Strainers are available in SS, PB, NB and CP
- Primer tapped with 1/2" plug

	A	B	C	D
Without ring	Over 3"	6-1/8"	4-5/8" - 6"	4-11/16" - 6-7/16"
With ring	Over 3"	6-1/2"	4-5/8" - 6"	4-3/4" - 6-1/2"

PVC

PART NO.	STRAINER	CTN QTY
D50351	6" SS	1
D50352	6" PB	1
D50353	6" PB with ring	1
D50354	6" NB	1
D50355	6" NB with ring	1
D50356	6" CP	1
D50357	6" CP with ring	1

ABS

PART NO.	STRAINER	CTN QTY
D51351	6" SS	1
D51352	6" PB	1
D51353	6" PB with ring	1
D51354	6" NB	1
D51355	6" NB with ring	1
D51356	6" CP	1
D51357	6" CP with ring	1

### 4" Heavy Duty Drain Base with 4" Plastic Spuds

**6" Round Strainer**  
Fits Over 4" Schedule 40 DWV Pipe



- 10" Pan
- Stainless steel strainers are .06" thick
- PB, NB and CP strainers are 3/16" thick
- Strainers are available in SS, PB, NB and CP
- Primer tapped with 1/2" plug

	A	B	C	D
Without ring	Over 4"	6-1/8"	11"	5-1/16" - 6-13/16"
With ring	Over 4"	6-1/2"	11"	5-1/4" - 6-15/16"

PVC

PART NO.	STRAINER	CTN QTY
D50362	6" SS	1
D50363	6" PB	1
D50364	6" PB with ring	1
D50365	6" NB	1
D50366	6" NB with ring	1
D50367	6" CP	1
D50368	6" CP with ring	1

ABS

PART NO.	STRAINER	CTN QTY
D51362	6" SS	1
D51363	6" PB	1
D51364	6" PB with ring	1
D51365	6" NB	1
D51366	6" NB with ring	1
D51367	6" CP	1
D51368	6" CP with ring	1

### 3" Heavy Duty Drain Base with 4" Metal Spuds

**5" Round Strainer**  
Fits Over 3" Schedule 40 DWV Pipe



- 10" Pan
- Strainers are 3/16" thick
- Strainers are available in PB and NB
- Primer tapped with 1/2" plug
- Adjustable (see dimension D)

	A	B	C	D
Metal	Over 3"	5"	4-5/8" - 6"	5" - 6-1/2"

PVC

PART NO.	STRAINER	CTN QTY
D50361	5" PB	1
D50360	5" NB	1

ABS

PART NO.	STRAINER	CTN QTY
D51361	5" PB	1
D51360	5" NB	1

### 4" Heavy Duty Drain Base with 4" Metal Spuds

**5" Round Strainer**  
Fits Over 4" Schedule 40 DWV Pipe



- 10" Pan
- Strainers are 3/16" thick
- Strainers are available in PB and NB
- Primer tapped with 1/2" plug
- Adjustable (see dimension D)

	A	B	C	D
Metal	Over 4"	5"	11"	4-5/8" - 5-7/8"

PVC

PART NO.	STRAINER	CTN QTY
D50372	5" PB	1
D50371	5" NB	1

ABS

PART NO.	STRAINER	CTN QTY
D51372	5" PB	1
D51371	5" NB	1

### Internal Pipe Cleanout

Solvent Welds Into Schedule 40 DWV Pipe

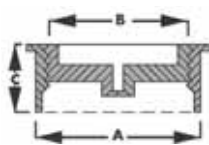

MADE IN THE USA

- Allows pipe to be cut flush with floor or wall
- Countersunk plug included

A	B	C
Inside 2"	1-1/2"	1"
Inside 3"	2-1/2"	1-1/8"
Inside 4"	3-1/2"	1-1/4"

PVC

PART NO.	PIPE SIZE	PLUG SIZE	OD	CTN QTY
C60106	2"	1-1/2" IPS	1-7/8"	10
C60007	3"	2-1/2" IPS	2-13/16"	10
C60008	4"	3-1/2" IPS	4"	50
C60116	2"	1-1/2" with insert	—	10
C60117	3"	2-1/2" with insert	—	10
C60118	4"	3-1/2" with insert	—	10

ABS

PART NO.	PIPE SIZE	PLUG SIZE	OD	CTN QTY
C60107	2"	1-1/2" IPS	1-7/8"	10
C60011	3"	2-1/2" IPS	2-13/16"	10
C60012	4"	3-1/2" IPS	4"	10

### Heavy Duty Internal Pipe Cleanout

Solvent Welds Into Schedule 40 DWV Pipe

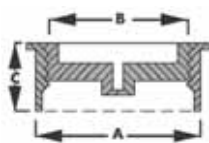

MADE IN THE USA

- Allows pipe to be cut flush with floor or wall
- Countersunk plug included

A	B	C
Inside 3"	2-1/4"	1-7/8"
Inside 4"	3-1/2"	2"

PVC

PART NO.	SIZE	PLUG SIZE	CTN QTY
C60207	3"	2" IPS	10
C60108	4"	3" IPS	10

ABS

PART NO.	SIZE	PLUG SIZE	CTN QTY
C60211	3"	2" IPS	10
C60112	4"	3" IPS	10

### Hub/Fitting Cleanouts

Fits Inside 4" Schedule 40 DWV Fittings

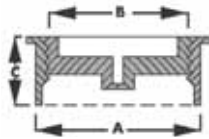

MADE IN THE USA

- 3-1/2" IPS countersunk plug
- Solvent welds into 4" fitting hubs

A	B	C
4-1/2"	3-7/8"	2-3/16"

PVC

PART NO.	DESCRIPTION	CTN QTY
C60009	4"	10

ABS

PART NO.	DESCRIPTION	CTN QTY
C60010	4"	10

### Fit-Flush Cleanout

2" x 3" Fits Over 2" or Inside 3" Schedule 40 DWV Pipe  
3" x 4" Fits Over 3" or Inside 4" Schedule 40 DWV Pipe

MADE IN THE USA

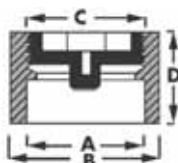

- Built-in stop
- Fits flush everytime

A	B	C	D
Over 2"	Inside 3"	2"	2"
Over 3"	Inside 4"	3"	2-1/2"

PVC

PART NO.	SIZE	PLUG SIZE	OD	CTN QTY
C61023	2" x 3"	2" IPS	2-3/8"	1
C61034	3" x 4"	3" IPS	3-1/2"	1
C61223	2" x 3"	2" IPS brass	2-3/8"	1
C61234	3" x 4"	3" IPS brass	3-1/2"	1
C61432	2" x 3"	2" with insert	2-3/8"	1
C61434	3" x 4"	3" with insert	3-1/2"	1

ABS

PART NO.	SIZE	PLUG SIZE	OD	CTN QTY
C61123	2" x 3"	2" IPS	2-3/8"	1
C61134	3" x 4"	3" IPS	3-1/2"	1

### Countersunk Cleanout Plugs w/Insert



- White plastic
- With threaded brass insert for cleanout covers

MADE IN THE USA

PART NO.	DESCRIPTION	CTN QTY
P49915	1-1/2"	25
P49920	2"	25
P49925	2-1/2"	25
P49930	3"	25
P49935	3-1/2"	25
P49940	4"	25

### Raised Head Cleanout Plugs



- White plastic

MADE IN THE USA

PART NO.	DESCRIPTION	CTN QTY
P49150	1-1/2"	50
P49200	2"	50
P49250	2-1/2"	25
P49350	3-1/2"	25
P49400	4"	10
P49600	6"	10

### Countersunk Cleanout Plugs



- White plastic

MADE IN THE USA

PART NO.	DESCRIPTION	CTN QTY
P49015	1-1/2"	25
P49002	2"	25
P49025	2-1/2"	25
P49003	3"	25
P49035	3-1/2"	25
P49004	4"	25

### 4" PVC Hub Fit Cleanout with 3-1/2" Countersunk Brass Plug



- Fits flush
- Fits inside 4" hub or Schedule 40 DWV fitting

MADE IN THE USA

PART NO.	DESCRIPTION	CTN QTY
C61009	4" PVC hub fit cleanout	10

### General Purpose Cleanouts

3" x 4" Fits Over 3" or Inside 4" Schedule 40 DWV Pipe  
4" Fits Over 4" Schedule 40 DWV Pipe

MADE IN THE USA

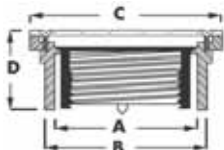

- Supplied with a combination test plug installed

A	B	C	D
Over 3"	Inside 4"	5-3/16"	2-1/2"
Over 4"	—	6-1/8"	2-1/2"

PVC

PART NO.	DESCRIPTION	CTN QTY
C60162	3" x 4" w/NB cover	5
C60165	3" x 4" w/NB cover & ring	5
C60160	3" x 4" w/PB cover	5
C60164	3" x 4" w/PB cover & ring	5
C60142	4" w/NB cover	5
C60146	4" w/NB cover & ring	5
C60140	4" w/PB cover	5
C60144	4" w/PB cover & ring	5

ABS

PART NO.	DESCRIPTION	CTN QTY
C60163	3" x 4" w/NB cover	5
C60167	3" x 4" w/NB cover & ring	5
C60161	3" x 4" w/PB cover	5
C60166	3" x 4" w/PB cover & ring	5
C60143	4" w/NB cover	5
C60147	4" w/NB cover & ring	5
C60141	4" w/PB cover	5
C60145	4" w/PB cover & ring	5

### General Purpose Access Fittings

3" x 4" Fits Over 3" or Inside 4" Schedule 40 DWV Pipe  
4" Fits Over 4" Schedule 40 DWV Pipe

MADE IN THE USA

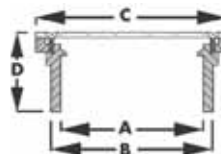

- For use with internal pipe cleanout, order separately

A	B	C	D
Over 3"	Inside 4"	5-3/16"	2-1/2"
Over 4"	—	6-1/8"	2-1/2"

PVC

PART NO.	DESCRIPTION	CTN QTY
C60062	3" x 4" w/NB cover	5
C60065	3" x 4" w/NB cover & ring	5
C60060	3" x 4" w/PB cover	5
C60064	3" x 4" w/PB cover & ring	5
C60042	4" w/NB cover	5
C60046	4" w/NB cover & ring	5
C60040	4" w/PB cover	5
C60044	4" w/PB cover & ring	5

ABS

PART NO.	DESCRIPTION	CTN QTY
C60063	3" x 4" w/NB cover	5
C60067	3" x 4" w/NB cover & ring	5
C60061	3" x 4" w/PB cover	5
C60066	3" x 4" w/PB cover & ring	5
C60043	4" w/NB cover	5
C60047	4" w/NB cover & ring	5
C60041	4" w/PB cover	5
C60045	4" w/PB cover & ring	5

**Snap-in Access Fittings**

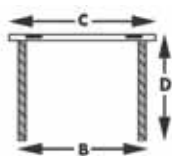

MADE IN THE  
**USA**

A	B	C	D
3"	3-1/16"	3-1/2"	2"
4"	4"	4-1/2"	2"

**PVC**

PART NO.	DESCRIPTION	CTN QTY
C60013	3" with SS strainer	20
C60014	4" with SS strainer	20

**PVC Internal Cleanout w/SS Cover**



MADE IN THE  
**USA**

PART NO.	DESCRIPTION	CTN QTY
C60015	3" w/5" SS external wall cover	1
C60016	4" w/6" SS external wall cover	1

**Saddle Tees and Kits**



MADE IN THE  
**USA**

- Use bushing to reduce 2" unit to 1-1/2"
- Kits include V-bolts, nuts and washers
- Conversion kit also contains gasket mat for use with cast iron pipe
- Solvent branch

PART NO.	DESCRIPTION	CTN QTY
S26014	3" x 2" Saddle tee only	20
S26015	4" x 2" Saddle tee only	10
S26016	4" x 3" Saddle tee only	10
S26017	4" x 4" Saddle tee only	10
S26004	3" x 2" Saddle tee kit less gasket	20
S26005	4" x 2" Saddle tee kit less gasket	10
S26006	4" x 3" Saddle tee kit less gasket	10
S26007	4" x 4" Saddle tee kit less gasket	10
S26009	3" x 2" Saddle tee conversion kit with gasket	20
S26010	4" x 2" Saddle tee conversion kit with gasket	10
S26011	4" x 3" Saddle tee conversion kit with gasket	10
S26012	4" x 4" Saddle tee conversion kit with gasket	10
S26008	6" x 7" x 1/4" closed cell foam gasket	20

**Sewer Relief Plugs**



- High-density construction
- Eliminates costly damages caused by sewer gas
- Spring-loaded to close automatically to eliminate sewer gas
- Made of ABS

MADE IN THE  
**USA**

PART NO.	DESCRIPTION	CTN/MSTR
S25150	1-1/2"	1/50
S25200	2"	1/50
S25250	2-1/2"	1/100
S25300	3"	1/100
S25350	3-1/2"	1/100
S25400	4"	1/100

**Test Tee w/Plug**



- Easy pop top test
- PVC Plug included
- Test up to 3 floors

MADE IN THE  
**USA**

PART NO.	DESCRIPTION	CTN/MSTR
C67450	2"	1/10
C67451	3"	1/12

### Round Covers w/2" Plastic Spuds



• Supplied with 2"IPS / 2-1/2" OD countersunk t-cone test plug



**PVC**

PART NO.	IPS	COVER	CTN/MSTR
D59920	2"	4" PB	1
D59921	2"	4" PB with ring	1
D59922	2"	4" NB	1
D59923	2"	4" NB with ring	1

**ABS**

PART NO.	IPS	COVER	CTN/MSTR
D59924	2"	4" PB	1
D59925	2"	4" PB with ring	1
D59926	2"	4" NB	1
D59927	2"	4" NB with ring	1

### Round Covers w/3" Plastic Spuds



• Supplied with 2-1/2" IPS / 3" OD countersunk plug



**PVC**

PART NO.	IPS	COVER	CTN/MSTR
D59904	3"	6" PB	1
D59908	3"	6" PB with ring	1
D59905	3"	6" NB	1
D59909	3"	6" NB with ring	1

**ABS**

PART NO.	IPS	COVER	CTN/MSTR
D57904	3"	6" PB	1
D57908	3"	6" PB with ring	1
D57905	3"	6" NB	1
D57909	3"	6" NB with ring	1

### Round Covers w/3" Metal Spuds



• Supplied with 2-1/2" IPS / 3" OD countersunk plug



PART NO.	IPS	COVER	CTN/MSTR
C37801	3"	5" PB	1/20
C37803	3"	5" NB	1/20
C37800	3"	5" CP	1/20

### Round Covers w/3-1/2" Plastic Spuds



• Supplied with 3" IPS countersunk plug



**PVC**

PART NO.	IPS	COVER	CTN/MSTR
D59943	3-1/2"	5" PB	1
D59944	3-1/2"	5" PB with ring	1
D59945	3-1/2"	5" NB	1
D59946	3-1/2"	5" NB with ring	1
D59901	3-1/2"	6" PB	1
D59906	3-1/2"	6" PB with ring	1
D59902	3-1/2"	6" NB	1
D59907	3-1/2"	6" NB with ring	1

**ABS**

PART NO.	IPS	COVER	CTN/MSTR
D59947	3-1/2"	5" PB	1
D59948	3-1/2"	5" PB with ring	1
D59949	3-1/2"	5" NB	1
D59950	3-1/2"	5" NB with ring	1
D57901	3-1/2"	6" PB	1
D57906	3-1/2"	6" PB with ring	1
D57902	3-1/2"	6" NB	1
D57907	3-1/2"	6" NB with ring	1

### Round Covers w/4" Plastic Spuds



• Supplied with 3" IPS countersunk plug



**PVC**

PART NO.	IPS	COVER	CTN/MSTR
D59914	4"	6" PB	1
D59915	4"	6" PB with ring	1
D59916	4"	6" NB	1
D59917	4"	6" NB with ring	1

**ABS**

PART NO.	IPS	COVER	CTN/MSTR
D57914	4"	6" PB	1
D57915	4"	6" PB with ring	1
D57916	4"	6" NB	1
D57917	4"	6" NB with ring	1

### Round Covers w/3-1/2" Metal Spuds



• Supplied with 3-1/2" IPS countersunk plug



PART NO.	IPS	COVER	CTN/MSTR
C37811	3-1/2"	5" PB	1/18
C37810	3-1/2"	5" NB	1/18

**Round Covers w/4" Metal Spuds**



• Supplied with 3-1/2" IPS countersunk plug



PART NO.	IPS	COVER	CTN/MSTR
C37806	4"	5" PB	1/20
C37805	4"	5" NB	1/20

**Round Covers w/4" Metal Spuds**



• Supplied with 4" IPS countersunk plug



PART NO.	IPS	COVER	CTN/MSTR
C37808	4"	6" PB	1/8
C37807	4"	6" NB	1/8

**Square Covers w/4" Plastic Spuds**



• Supplied with 3" IPS countersunk plug



PVC			
PART NO.	IPS	COVER	CTN/MSTR
D59918	4"	7" PB	1
D59919	4"	7" NB	1

ABS			
PART NO.	IPS	COVER	CTN/MSTR
D57918	4"	7" PB	1
D57919	4"	7" NB	1

**Square Covers w/3" Plastic Spuds**



• Supplied with 2-1/2" IPS / 3" OD countersunk plug



PVC			
PART NO.	IPS	COVER	CTN/MSTR
D59912	3"	7" PB	1
D59913	3"	7" NB	1

ABS			
PART NO.	IPS	COVER	CTN/MSTR
D57912	3"	7" PB	1
D57913	3"	7" NB	1

**Square Covers w/3-1/2" Plastic Spuds**



• Supplied with 3" IPS countersunk plug



PVC			
PART NO.	IPS	COVER	CTN/MSTR
D59910	3-1/2"	7" PB	1
D59911	3-1/2"	7" NB	1

ABS			
PART NO.	IPS	COVER	CTN/MSTR
D57910	3-1/2"	7" PB	1
D57911	3-1/2"	7" NB	1

### 4" Hub Fit Base with 3-1/2" Plastic Spuds

#### 5" Round Cover

Fits Inside 4" Schedule 40 DWV Pipe

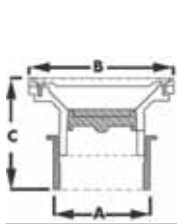

- Supplied with 3" IPS (3-1/2" OD) countersunk plug
- Covers available in PB and NB
- Covers are 3/16" thick
- Adjustable (see dimension C)

	A	B	C
Without ring	4" Hub fit	5-3/16"	3-1/8" – 4-5/8"
With ring	4" Hub fit	5-1/2"	3-5/16" – 4-13/16"

#### PVC

PART NO.	COVER	CTN QTY
C59200	5" PB	1
C59201	5" PB with ring	1
C59202	5" NB	1
C59203	5" NB with ring	1

#### ABS

PART NO.	COVER	CTN QTY
C59204	5" PB	1
C59205	5" PB with ring	1
C59206	5" NB	1
C59207	5" NB with ring	1

### 4" Hub Fit Base with 3-1/2" Plastic Spuds

#### 6" Round Cover

Fits Inside 4" Schedule 40 DWV Pipe

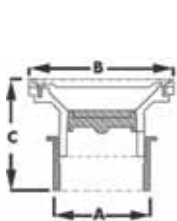

- Supplied with 3" IPS (3-1/2" OD) countersunk plug
- Covers available in PB and NB
- Covers are 3/16" thick
- Adjustable (see dimension C)

	A	B	C
Without ring	4" Hub fit	6-1/8"	3-1/8" – 4-5/8"
With ring	4" Hub fit	6-1/2"	3-5/16" – 4-13/16"

#### PVC

PART NO.	COVER	CTN QTY
C59001	6" PB	1
C59005	6" PB with ring	1
C59003	6" NB	1
C59007	6" NB with ring	1

#### ABS

PART NO.	COVER	CTN QTY
C59002	6" PB	1
C59006	6" PB with ring	1
C59004	6" NB	1
C59008	6" NB with ring	1

### 4" Hub Fit Base with 3-1/2" Plastic Spuds

#### 7" Square Top

Fits Inside 4" Schedule 40 DWV Pipe

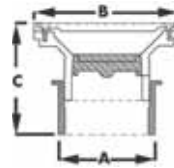

- Supplied with 3" IPS (3-1/2" OD) countersunk plug
- Covers available in PB and NB
- Covers are 3/16" thick
- Adjustable (see dimension C)

	A	B	C
Square	4" Hub fit	7"	3-3/8" – 4-15/16"

#### PVC

PART NO.	COVER	CTN QTY
C59050	7" PB	1
C59052	7" NB	1

#### ABS

PART NO.	COVER	CTN QTY
C59051	7" PB	1
C59053	7" NB	1

### 4" Hub Fit Base with 3-1/2" Metal Spuds

#### 5" Round Cover

Fits Inside 4" Schedule 40 DWV Pipe

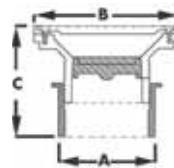

- Supplied with 3" IPS (3-1/2" OD) countersunk plug
- Covers available in PB and NB
- Covers are 3/16" thick
- Adjustable (see dimension C)

	A	B	C
Metal	4" Hub fit	5-3/16"	3-1/4" – 4-1/4"

#### PVC

PART NO.	COVER	CTN QTY
C59060	5" PB	1
C59062	5" NB	1

#### ABS

PART NO.	COVER	CTN QTY
C59061	5" PB	1
C59063	5" NB	1

### 3" x 4" Pipe Fit Base with 3-1/2" Plastic Spuds

#### 5" Round Cover

Fits Over 3" or Inside 4" Schedule 40 DWV Pipe

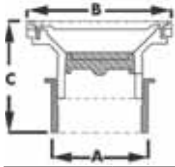

- Supplied with 3" IPS (3-1/2" OD) countersunk plug
- Covers available in PB and NB
- Covers are 3/16" thick
- Adjustable (see dimension D)

	A	B	C
Without ring	Over 3" Pipe Inside 4" Pipe	5-3/16"	3-1/8" - 4-5/8"
With ring	Over 3" Pipe Inside 4" Pipe	5-1/2"	3-5/16" - 4-13/16"

#### PVC

PART NO.	COVER	CTN QTY
C59216	5" PB	1
C59217	5" PB with ring	1
C59218	5" NB	1
C59219	5" NB with ring	1

#### ABS

PART NO.	COVER	CTN QTY
C59220	5" PB	1
C59221	5" PB with ring	1
C59222	5" NB	1
C59223	5" NB with ring	1

### 3" x 4" Pipe Fit Base with 3-1/2" Plastic Spuds

#### 6" Round Cover

Fits Over 3" or Inside 4" Schedule 40 DWV Pipe

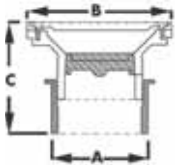

- Supplied with 3" IPS (3-1/2" OD) countersunk plug
- Covers available in PB and NB
- Covers are 3/16" thick
- Adjustable (see dimension D)

	A	B	C
Without ring	Over 3" Pipe Inside 4" Pipe	6-1/8"	3-1/8" - 4-5/8"
With ring	Over 3" Pipe Inside 4" Pipe	6-1/2"	3-5/16" - 4-13/16"

#### PVC

PART NO.	COVER	CTN QTY
C59010	6" PB	1
C59014	6" PB with ring	1
C59012	6" NB	1
C59016	6" NB with ring	1

#### ABS

PART NO.	COVER	CTN QTY
C59011	6" PB	1
C59015	6" PB with ring	1
C59013	6" NB	1
C59017	6" NB with ring	1

### 3" x 4" Pipe Fit Base with 3-1/2" Plastic Spuds

#### 7" Square Top

Fits Over 3" or Inside 4" Schedule 40 DWV Pipe

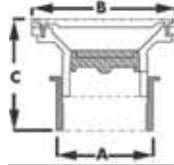

- Supplied with 3" IPS (3-1/2" OD) countersunk plug
- Covers available in PB and NB
- Covers are 3/16" thick
- Adjustable (see dimension D)

	A	B	C
Square	Over 3" Pipe Inside 4" Pipe	7"	5-15/16" - 7-1/2"

#### PVC

PART NO.	COVER	CTN QTY
C59054	7" PB	1
C59056	7" NB	1

#### ABS

PART NO.	COVER	CTN QTY
C59055	7" PB	1
C59057	7" NB	1

### 3" x 4" Pipe Fit Base with 3-1/2" Metal Spuds

#### 5" Round Cover

Fits Over 3" or Inside 4" Schedule 40 DWV Pipe

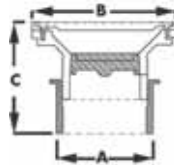

- Supplied with 3" IPS (3-1/2" OD) countersunk plug
- Covers available in PB and NB
- Covers are 3/16" thick
- Adjustable (see dimension D)

	A	B	C
Metal	Over 3" Pipe Inside 4" Pipe	5-3/16"	5-3/4" - 7"

#### PVC

PART NO.	COVER	CTN QTY
C59068	5" PB	1
C59070	5" NB	1

#### ABS

PART NO.	COVER	CTN QTY
C59069	5" PB	1
C59071	5" NB	1

### 4" Over Pipe Fit Base with 3-1/2" Plastic Spuds

#### 5" Round Cover

Fits Over 4" Schedule 40 DWV Pipe

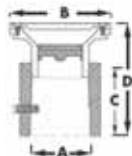

- Supplied with 3" IPS (3-1/2" OD) countersunk plug
- Covers available in PB and NB
- Covers are 3/16" thick
- Adjustable (see dimension D)

	A	B	C	D
Without ring	Over 4" Pipe	5-3/16"	4-1/4"	5-15/16" – 7-1/2"
With ring	Over 4" Pipe	5-1/2"	4-1/4"	6-1/16" – 7-5/8"

#### PVC

PART NO.	COVER	CTN QTY
C59208	5" PB	1
C59209	5" PB with ring	1
C59210	5" NB	1
C59211	5" NB with ring	1

#### ABS

PART NO.	COVER	CTN QTY
C59212	5" PB	1
C59213	5" PB with ring	1
C59214	5" NB	1
C59215	5" NB with ring	1

### 4" Over Pipe Fit Base with 3-1/2" Plastic Spuds

#### 6" Round Cover

Fits Over 4" Schedule 40 DWV Pipe

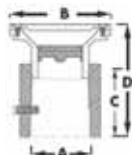

- Supplied with 3" IPS (3-1/2" OD) countersunk plug
- Covers available in PB and NB
- Covers are 3/16" thick
- Adjustable (see dimension D)

	A	B	C	D
Without ring	Over 4" Pipe	6-1/8"	4-1/4"	5-15/16" – 7-1/2"
With ring	Over 4" Pipe	6-1/2"	4-1/4"	6-1/16" – 7-5/8"

#### PVC

PART NO.	COVER	CTN QTY
C60001	6" PB	1
C60022	6" PB with ring	1
C60020	6" NB	1
C60024	6" NB with ring	1

#### ABS

PART NO.	COVER	CTN QTY
C60003	6" PB	1
C60023	6" PB with ring	1
C60021	6" NB	1
C60025	6" NB with ring	1

### 4" Over Pipe Fit Base with 3-1/2" Plastic Spuds

#### 7" Square Cover

Fits Over 4" Schedule 40 DWV Pipe

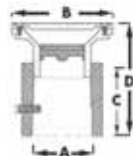

- Supplied with 3" IPS (3-1/2" OD) countersunk plug
- Covers available in PB and NB
- Covers are 3/16" thick
- Adjustable (see dimension D)

	A	B	C	D
Square	Over 4" Pipe	7"	4-1/4"	6-1/8" – 7-11/16"

#### PVC

PART NO.	COVER	CTN QTY
C60050	7" PB	1
C60052	7" NB	1

#### ABS

PART NO.	COVER	CTN QTY
C60051	7" PB	1
C60053	7" NB	1

### 4" Over Pipe Fit Base with 3-1/2" Metal Spuds

#### 5" Round Cover

Fits Over 4" Schedule 40 DWV Pipe

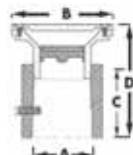

- Supplied with 3" IPS (3-1/2" OD) countersunk plug
- Covers available in PB and NB
- Covers are 3/16" thick
- Adjustable (see dimension D)

	A	B	C	D
Metal	Over 4" Pipe	5"	4-1/4"	6" – 7-1/16"

#### PVC

PART NO.	COVER	CTN QTY
C59064	5" PB	1
C59066	5" NB	1

#### ABS

PART NO.	COVER	CTN QTY
C59065	5" PB	1
C59067	5" NB	1

### 4" Over Pipe Fit Base with 4" Plastic Spuds

#### 6" Round Cover

Fits Over 4" Schedule 40 DWV Pipe

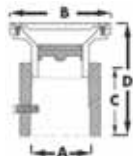

- Supplied with 3" IPS (3-1/2" OD) countersunk plug
- Covers available in PB and NB
- Covers are 3/16" thick
- Adjustable (see dimension D)

	A	B	C	D
Without ring	Over 4" Pipe	6"	4-3/4"	6-1/16" - 7-3/16"
With ring	Over 4" Pipe	6-1/8"	4-3/4"	6-1/8" - 7-1/4"

#### PVC

PART NO.	COVER	CTN QTY
C60070	6" PB	1
C60071	6" PB with ring	1
C60072	6" NB	1
C60073	6" NB with ring	1

#### ABS

PART NO.	COVER	CTN QTY
C60076	6" PB	1
C60077	6" PB with ring	1
C60078	6" NB	1
C60079	6" NB with ring	1

### 4" Over Pipe Fit Base with 4" Metal Spuds

#### 5" or 6" Round Cover

Fits Over 4" Schedule 40 DWV Pipe

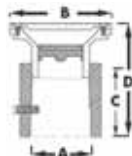

- 5" Supplied with 3" IPS (3-1/2" OD) countersunk plug
- 6" Supplied with 4" IPS plug
- Covers available in PB and NB
- Covers are 3/16" thick
- Adjustable (see dimension D)

	A	B	C	D
Metal	Over 4" Pipe	5"	4-3/4"	5" - 6"
Metal	Over 4" Pipe	6"	4-3/4"	5" - 6"

#### PVC

PART NO.	COVER	CTN QTY
C60082	5" NB	1
C60092	5" PB	1
C60094	6" NB	1
C60096	6" PB	1

#### ABS

PART NO.	COVER	CTN QTY
C60083	5" NB	1
C60095	6" NB	1
C60097	6" PB	1

### 4" Over Pipe Fit Base with 4" Plastic Spuds

#### 7" Square Top

Fits Over 4" Schedule 40 DWV Pipe

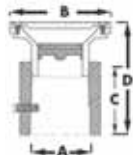

- Supplied with 3" IPS (3-1/2" OD) countersunk plug
- Covers available in PB and NB
- Covers are 3/16" thick
- Adjustable (see dimension D)

	A	B	C	D
Square	Over 4" Pipe	7"	4-3/4"	6-3/16" - 7-3/8"

#### PVC

PART NO.	COVER	CTN QTY
C60074	7" PB	1
C60075	7" NB	1

#### ABS

PART NO.	COVER	CTN QTY
C60080	7" PB	1
C60081	7" NB	1

### 3" Over Pipe Fit Base with 3" Plastic Spuds

#### 6" Round Cover

Fits Over 3" Schedule 40 DWV Pipe

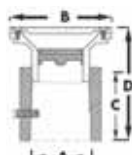

- Supplied with 2-1/2" IPS (3" OD) countersunk plug
- Covers are 3/16" thick
- Adjustable (see dimension D)

	A	B	C	D
Without ring	Over 3" Pipe	6-1/8"	4-1/2"	5-7/8" - 7-1/8"
With ring	Over 3" Pipe	6-1/2"	4-1/2"	6" - 7-3/16"

#### PVC

PART NO.	COVER	CTN QTY
C60026	6" PB	1
C60030	6" PB with ring	1
C60028	6" NB	1
C60032	6" NB with ring	1

#### ABS

PART NO.	COVER	CTN QTY
C60027	6" PB	1
C60031	6" PB with ring	1
C60029	6" NB	1
C60033	6" NB with ring	1

### 3" Over Pipe Fit Base with 3" Plastic Spuds

#### 7" Square Top

Fits Over 3" Schedule 40 DWV Pipe

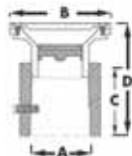

- Supplied with 2-1/2" IPS (3" OD) countersunk plug
- Covers are 3/16" thick
- Adjustable (see dimension D)

	A	B	C	D
Square	Over 3" Pipe	7"	4-1/2"	6" - 7-3/16"

#### PVC

PART NO.	COVER	CTN QTY
C60054	7" PB	1
C60056	7" NB	1

#### ABS

PART NO.	COVER	CTN QTY
C60055	7" PB	1
C60057	7" NB	1

### 3" Over Pipe Fit Base with 3" Metal Spuds

#### 5" Round Cover

Fits Over 3" Schedule 40 DWV Pipe

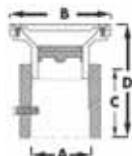

- Supplied with 2-1/2" IPS (3" OD) countersunk plug
- Covers are 3/16" thick
- Adjustable (see dimension D)

	A	B	C	D
Metal	Over 3" Pipe	5-3/16"	4-1/2"	5" - 6"

#### PVC

PART NO.	COVER	CTN QTY
C60086	5" PB	1
C60084	5" NB	1
C60088	5" CP	1

#### ABS

PART NO.	COVER	CTN QTY
C60087	5" PB	1
C60085	5" NB	1
C60089	5" CP	1

### 4" Inside Pipe Fit Base with 3" Plastic Spuds

#### 6" Round Cover

Fits Inside 4" Schedule 40 DWV Pipe

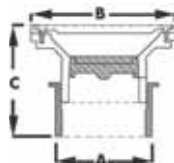

- Supplied with 3" IPS (3-1/2" OD) countersunk plug
- Covers available in PB and NB
- Covers are 3/16" thick
- Adjustable (see dimension D)

	A	B	C
Without ring	Inside 4" Pipe	6-1/8"	3-7/8" - 4-5/8"
With ring	Inside 4" Pipe	6-1/2"	4" - 4-3/4"

#### PVC

PART NO.	COVER	CTN QTY
C59020	6" PB	1
C59024	6" PB with ring	1
C59022	6" NB	1
C59026	6" NB with ring	1

#### ABS

PART NO.	COVER	CTN QTY
C59021	6" PB	1
C59025	6" PB with ring	1
C59023	6" NB	1
C59027	6" NB with ring	1

### 4" Inside Pipe Fit Base with 3" Plastic Spuds

#### 7" Square Top

Fits Inside 4" Schedule 40 DWV Pipe

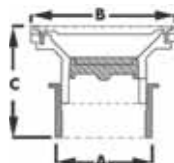

- Supplied with 3" IPS (3-1/2" OD) countersunk plug
- Covers available in PB and NB
- Covers are 3/16" thick
- Adjustable (see dimension D)

	A	B	C
Square	Inside 4" Pipe	7"	4" - 4-7/8"

#### PVC

PART NO.	COVER	CTN QTY
C59028	7" PB	1
C59030	7" NB	1

#### ABS

PART NO.	COVER	CTN QTY
C59029	7" PB	1
C59031	7" NB	1

## 4" Inside Pipe Fit Base with 3" Metal Spuds

### 5" Round Cover

Fits Inside 4" Schedule 40 DWV Pipe

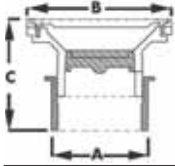

- Supplied with 3" IPS (3-1/2" OD) countersunk plug
- Covers available in PB, NB and CP
- Covers are 3/16" thick
- Adjustable (see dimension D)

	A	B	C
Metal	Inside 4" Pipe	5"	2-7/16" – 3-1/2"

#### PVC

PART NO.	COVER	CTN QTY
C59090	5" NB	1
C59092	5" PB	1
C59094	5" CP	1

#### ABS

PART NO.	COVER	CTN QTY
C59091	5" NB	1
C59093	5" PB	1
C59095	5" CP	1

## 2" x 3" Cleanouts w/2" Plastic Spud

### 4" Round Cover

Fits Over 2" or Inside 3" Schedule 40 DWV Pipe

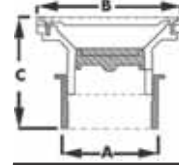

MADE IN THE USA

- Supplied with 2" t-cone test plug installed
- Covers available in PB and NB

	A	B	C
Without ring	2"	4-1/4"	2-1/4"
With ring	2"	4-1/2"	2-3/8"

#### PVC

PART NO.	COVER	CTN QTY
C59096	4" PB	1
C59097	4" PB with ring	1
C59098	4" NB	1
C59099	4" NB with ring	1

#### ABS

PART NO.	COVER	CTN QTY
C59100	4" PB	1
C59101	4" PB with ring	1
C59102	4" NB	1
C59103	4" NB with ring	1

**Round Slop Sinks**

Fits Over 3" or Inside 4" Pipe

MADE IN THE USA

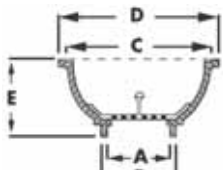

- 4-7/8" OD scoop strainer with stem for easy removal
- 12" diameter

A	B	C	D	E
3"	4"	11"	12"	6-3/8"

PART NO.	DESCRIPTION	CTN QTY
S55001	3" x 4" PVC sink and strainer	1
S55002	Replacement strainer	1

**Floor Sinks**

To Be Used with Coupling or Hub Kit

MADE IN THE USA

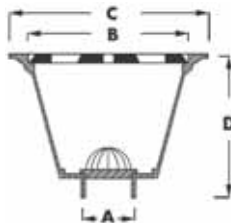

- 3/4" thick top grate in three styles
- 12" x 12" top flange

A	B	C	D
Inside 2" fitting	9-3/16"	12"	8"
Inside 3" fitting	9-3/16"	12"	8"
Inside 4" fitting	9-3/16"	12"	8"

PVC

PART NO.	DESCRIPTION	CTN QTY
S59002	2" sink only	1
S59003	3" sink only	1
S59004	4" sink only	1

ABS

PART NO.	DESCRIPTION	CTN QTY
S59302	2" sink only	1
S59303	3" sink only	1
S59304	4" sink only	1

**Complete PVC Floor Sink Kits**

MADE IN THE USA



- Includes sink, top grate and bottom strainer
- To be used with coupling or hub kit

PART NO.	DESCRIPTION	CTN QTY
S49042	2" - 1/2 top grate - dome bottom grate	1
S49052	2" - 3/4 top grate - dome bottom grate	1
S49062	2" - full top grate - dome bottom grate	1
S49072	2" - 1/2 top grate - flat bottom grate	1
S49082	2" - 3/4 top grate - flat bottom grate	1
S49092	2" - full top grate - flat bottom grate	1
S49043	3" - 1/2 top grate - dome bottom grate	1
S49053	3" - 3/4 top grate - dome bottom grate	1
S49063	3" - full top grate - dome bottom grate	1
S49073	3" - 1/2 top grate - flat bottom grate	1
S49083	3" - 3/4 top grate - flat bottom grate	1
S49093	3" - full top grate - flat bottom grate	1
S49044	4" - 1/2 top grate - dome bottom grate	1
S49054	4" - 3/4 top grate - dome bottom grate	1
S49064	4" - full top grate - dome bottom grate	1
S49074	4" - 1/2 top grate - flat bottom grate	1
S49084	4" - 3/4 top grate - flat bottom grate	1
S49094	4" - full top grate - flat bottom grate	1

**Pipe Fit Floor Sinks**

- 2" x 3" Fits Over 2" or Inside 3" Schedule 40 DWV Pipe
- 3" x 4" Fits Over 3" or Inside 4" Schedule 40 DWV Pipe
- 4" Fits Over 4" Schedule 40 DWV Pipe

MADE IN THE USA

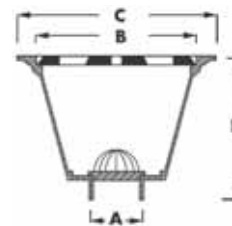

- 3/4" thick top grate in three styles
- 12" x 12" top flange
- Temp up to 180°

A	B	C	D
Over 2" Inside 3"	9-3/16"	12"	8"
Over 3" Inside 4"	9-3/16"	12"	8"
Over 4"	9-3/16"	12"	8"

PVC

PART NO.	DESCRIPTION	CTN QTY
S59102	2" x 3" sink only	1
S59103	3" x 4" sink only	1
S59104	4" sink only	1

ABS

PART NO.	DESCRIPTION	CTN QTY
S59402	2" x 3" sink only	1
S59403	3" x 4" sink only	1

**Complete PVC Floor Sink Kits-Pipe Fit**



• Includes sink, top grate and bottom strainer

PART NO.	DESCRIPTION	CTN QTY
S59042	2"x 3" - 1/2 top grate - dome bottom grate	1
S59052	2"x 3" - 3/4 top grate - dome bottom grate	1
S59062	2"x 3" - full top grate - dome bottom grate	1
S59072	2"x 3" - 1/2 top grate - flat bottom grate	1
S59082	2"x 3" - 3/4 top grate - flat bottom grate	1
S59092	2"x 3" - full top grate - flat bottom grate	1
S59043	3"x 4" - 1/2 top grate - dome bottom grate	1
S59053	3"x 4" - 3/4 top grate - dome bottom grate	1
S59063	3"x 4" - full top grate - dome bottom grate	1
S59073	3"x 4" - 1/2 top grate - flat bottom grate	1
S59083	3"x 4" - 3/4 top grate - flat bottom grate	1
S59093	3"x 4" - full top grate - flat bottom grate	1
S59044	4" - 1/2 top grate - dome bottom grate	1
S59054	4" - 3/4 top grate - dome bottom grate	1
S59064	4" - full top grate - dome bottom grate	1
S59074	4" - 1/2 top grate - flat bottom grate	1
S59084	4" - 3/4 top grate - flat bottom grate	1
S59094	4" - full top grate - flat bottom grate	1

**Half Top Grate for Floor Sinks**



• Accessories for all S49 and S59 series floor sinks

PVC		
PART NO.	DESCRIPTION	CTN QTY
S59012	1/2 top grate	10

ABS		
PART NO.	DESCRIPTION	CTN QTY
S59312	1/2 top grate	10

**Aluminum Dome Strainers for Floor Sinks**



• Accessories for all S49 and S59 series floor sinks

PART NO.	DESCRIPTION	CTN QTY
S60002	2" aluminum dome bottom strainer	10
S60003	3" aluminum dome bottom strainer	10
S60004	4" aluminum dome bottom strainer	10

**Full Top Grate for Floor Sinks**



• Accessories for all S49 and S59 series floor sinks

PVC		
PART NO.	DESCRIPTION	CTN QTY
S59010	Full top grate	10

ABS		
PART NO.	DESCRIPTION	CTN QTY
S59310	Full top grate	10

**Flat Aluminum Bottom Strainer for Floor Sinks**



• Accessories for all S49 and S59 series floor sinks

PART NO.	DESCRIPTION	CTN QTY
S60005	flat aluminum bottom strainer	10

**Three-Quarters Top Grate for Floor Sinks**



• Accessories for all S49 and S59 series floor sinks

PVC		
PART NO.	DESCRIPTION	CTN QTY
S59011	3/4 top grate	10

ABS		
PART NO.	DESCRIPTION	CTN QTY
S59311	3/4 top grate	10

### Roof Drains w/Cast Iron Dome

Fits over Schedule 40 DWV Pipe



MADE IN THE USA

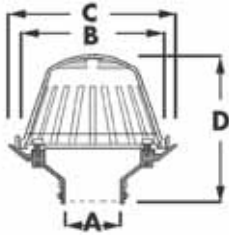

- Brass inserts in underside for underdeck clamps
- Dome has 50 square inches of free area

	A	B	C	D
Over 2" pipe	8-1/4"	11"	9"	
Over 3" pipe	8-1/4"	11"	9"	
Over 4" pipe	8-1/4"	11"	9"	
Over 6" pipe	8-1/4"	11"	8"	

PVC

PART NO.	DESCRIPTION	CTN QTY
R18001	2" cast iron dome	1
R18005	3" cast iron dome	1
R18006	4" cast iron dome	1
R18026	6" cast iron dome	1

ABS

PART NO.	DESCRIPTION	CTN QTY
R18009	2" cast iron dome	1
R18007	3" cast iron dome	1
R18008	4" cast iron dome	1

### Accessories for Roof Drains

MADE IN THE USA



PART NO.	DESCRIPTION	CTN QTY
R18011	2", 3" & 4" underdeck clamp	1
R18028	6" underdeck clamp	1
R18012	16" receiving pan	1
R18019	Plastic roof dome	1
R18020	Cast iron roof dome	1

E

### Roof Drains w/Plastic Dome

Fits over Schedule 40 DWV Pipe



MADE IN THE USA

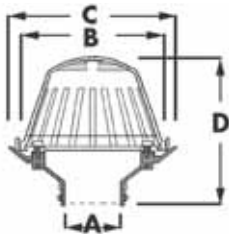

- Brass inserts in underside for underdeck clamps
- Dome has 50 square inches of free area

	A	B	C	D
Over 2" pipe	8-1/4"	11"	8"	
Over 3" pipe	8-1/4"	11"	8"	
Over 4" pipe	8-1/4"	11"	8"	
Over 6" pipe	8-1/4"	11"	8"	

PVC

PART NO.	DESCRIPTION	CTN QTY
R18013	2" plastic dome	1
R18014	3" plastic dome	1
R18015	4" plastic dome	1
R18027	6" plastic dome	1

ABS

PART NO.	DESCRIPTION	CTN QTY
R18016	2" plastic dome	1
R18017	3" plastic dome	1
R18018	4" plastic dome	1