



REAMS



Professional Irrigation & Landscape Supply



REAMS

Professional Irrigation & Landscape Supply

**From the President-
Bryce Bousquet**

In our continuing efforts to serve the green industry contractor, we hope that our REAMS product catalog will assist you in your buying decisions.

It is our goal to provide you with the very best products in the industry, at a fair price. We consider exceptional service as the standard, and we take great pride in our fast, courteous, and accurate filling of your orders.

Success in this industry is a TEAM effort. We sincerely invite you to join the REAMS Team this season. Thank you for your Business.

The REAMS Advantage

REAMS wants to be your business ally. With our customer's needs being our top priority, REAMS has extensive product lines to complete your Drainage, Irrigation, Landscaping, Landscape Lighting, and Water Feature projects.

Our friendly and knowledgeable staff will supply you with technical information, customize a training seminar, or give you on-the-job training. Whether you choose our quick delivery program or our speedy in-and-out of the store service, it will save your company money by avoiding downtime.

Since 1976 we have met our customer's every need by providing them with products, services, design, advice, and, above all, a dedicated team eager to help in any way we can.

Product Offerings

**Residential, Commercial, Sports Field, and Drip Irrigation - Vineyard Irrigation - Irrigation Central Controls
Drainage Products - Landscaping Products - Landscape Lighting - Water Features - Fire Rings - Ice Melt
Holiday Lighting - Outdoor Grills & Kitchen Products**

Service Offerings

Training & Education - Delivery - Design Services - Marketing Tools - Business Enhancement Products

Table of Contents

A	G	Q
Automatic Drains 4 Aerators 36 Air Gaps 6-7	Gasket Lube57 Grills37	Quick Coupler Valves 82
B	H	R
Backflow Preventers 4-7 Backflow Enclosures..... 8 Blu-Lock 78 Brass Fittings..... 8 Brass Manual Valves.... 76-77	Holiday Lighting..... 43-44 Hoses 38 Hose Fittings.....38	Rain Sensors..... 63 Rid O Rust..... 64 Rotors 65-67 Rotating Nozzles 64
C	I	S
Cement (PVC)..... 9-10 Check Valves 78 Clamps..... 10 Compression Fittings 11 Controllers..... 12-19 Copper Fittings..... 20 Copper Tube..... 20 Credit Application.... 123-124	Ice Melt.....38 Insert Fittings 39-41	Saddles 68 Spray Heads 69 Swing Joints 71 Swing Pipe 71 Swing Pipe Fittings 71
D	L	T
Drain Tile 21 Drain Tile Fittings 21 Drainage Products 21-26 Drip Irrigation 27-33 Ductile Iron Fittings 33 Dura Slope..... 25	Landscape Edging..... 41 Landscape Fabric42 Lighting Bulbs 51-52 Lighting Fixtures 45-49 Lighting Transformers..... 50	Tapes 72 Teflon Paste..... 72 Technical Info 104-121 Tools..... 72-76
E	M	V
Electrical Products 34 EZ Flow..... 21	Manifold Fittings 62 Mulch.....42	Valves - Electric 79-81 Valve Boxes 83
F	N	W
Filters..... 34 Fire Pits 35 Flo Span 11 Fountains 36 Freeze Sensor 76	Nozzles (Spray)53	Water Features 84-99 Weather Sensors..... 63 Wind Sensor 63 Wire Connectors..... 100 Wire - Irrigation 101-102 Wire - Lighting..... 102 Wire Locators & Testers . 103
P	P	W
	Plastic Ball Valves 78 Poly Pipe.....54 Poly Cut-Off Nipples.....55 Porous Pave55 Portable Irrigation.....56 PVC Pipe57 PVC Nipples56 PVC Fittings SCH 40 .. 58-61 PVC Gasket Fittings 62 Primer (PVC)..... 9-10 Pump Start Relays 63	

Automatic Drains



Blazing Drains

Model	Description
HP 1600	1 x 1/2" Ell w/drain
HP 1700	1 x 3/4" Ell w/drain
HP 1200	PVC 3/4 x 1/2" Ell w/drain
HP 1300	PVC 1 x 1/2" Ell w/drain
HP 1400	PVC 1 x 3/4" Ell w/drain
FP 1800	1/2" Swing Pipe Ell w/drain
FP 1900	3/4" Swing Pipe Ell w/drain
HP 2000	1/2" MPT Drain
HP 3000	3/4" MPT Drain
HP 4000	1/2" MPT Mainline Drain
SD1000	Siphon Drain
FP 1700	1/2" Swing Pipe Drain
FP 1800	3/4" Swing Pipe Drain



King Drains

Model	Description
21155	1" Male Adapter w/drain
16142	1 x 1/2" Ell w/drain
17145	1 x 3/4" Ell w/drain
22163	1/2" MPT Drain
23167	3/4" MPT Drain

Brass Auto Drain

Model	Description
910	1/2" MPT Brass Drain

Backflow Preventers



Febco 765 PVB

Model	Description
765DBV	3/4" 765 w/standard BV
765DUB	3/4" 765 w/union BV
765EBV	3/4" 765 w/standard BV
765EUB	1" 765 w/union BV
765FUB	1 1/4" 765 w/union BV
765GUB	1 1/2" 765 w/union BV
765HUB	2" 765 w/union BV



Febco 825YA RP

Model	Description
825DBV70	3/4" 825 DBV70
825EBV70	1" 825 EBV70
825HBV70	2" 825 HBV70



Febco 710 AVB

Model	Description
710E	710E 1" AVB
710F	710F 1 1/4" AVB
710H	710H 2" AVB

Febco 825Y RP

Model	Description
825DBV	3/4" 825 DBV
825EBV	1" 825 EBV
825GBV	1 1/2" 825 GBV
825HBV	2" 825 HBV



Febco Air Gap

Model	Description
F905082	AGD-Y Air Gap 3/4"-2"



www.reams.net

Backflow Preventers

Febco 850 DC



Model	Description
1112	3/4"
1113	1"
1115	1 1/2"
1116	2"



Febco 860 / 860U RP

Model	Description
1313	1"
2813	1" w/Unions
1316	2"
1312	3/4"



Watts 188A AVB



Model	Description
0340971	3/4"
0340972	1"
0340973	1 1/4"
0340974	1 1/2"
0340975	2"



Watts 800M4 PVB

Model	Description
0388013	800 M4 1/2" w/Freeze Check
0388014	800 M4 3/4" w/Freeze Check
0388015	800 M4 1" w/Freeze Check
0388016	800 M4 1 1/4" w/Freeze Check
0388017	800 M4 1 1/2" w/Freeze Check
0388018	800 M4 2" w/Freeze Check
0388001	800 M4 3/4"
0388002	800 M4 1"

Watts 007 DCA



Model	Description
0062020	3/4"
0062306	1"
0062681	1 1/4"
0062616	1 1/2"
0062427	2"

Watts 009 RPZA

Model	Description
0062094	1/2"
0063030	3/4"
0063020	1"
0063021	1" w/Strainer
0062920	1 1/4"
0062921	1 1/2"
0063010	2"

Watts U009A RPZA



Model	Description
0437012	1"
0436075	2"



www.reams.net

Backflow Preventers



Watts 909 RPZA



Model	Description
0387121	3/4"
0387129	1"
0385717	1 1/4"
0385718	1 1/2"
0385719	2"

Watts 919 RPZA



Model	Description
0062773	3/4"
0062774	1"
0062775	1 1/4"
0062776	1 1/2"
0062777	2"

Watts Series 7 DC



Model	Description
0061791	3/4" Dual Check
0061793	1" Dual Check



Air Gap

Model	Description
881399	3/4"
881376	3/4 - 1"
881378	1 1/4" - 3"

Watts Pressure Regulator



Model	Description
0069717	3/4" - 25 AUB
0069174	1" - 25 AUB
0070311	1 1/4" - 25 AUB
0070322	1 1/2" - 25 AUB
0070336	2" - 25 AUB



Watts TWS Shutoff

Model	Description
0722046	TWS 10"-1"
0722047	TWS 12"-1"

Allows contractor to shut off supply water from the outside of house. Great for winterizations!!!

Misc. Backflow



Model	Description
75HVBC	Hose End Vacuum Br.
0385496	TK9A Test Kit
0385511	TK 99E Test Kit



www.reams.net

Backflow Preventers



Wilkins 720 PVB

Model	Description
720A 3/4"	3/4"
720A 1"	1"



Wilkins AIR GAP / Y Strainer

Model	Description
AG4	3/4 - 1" AIR GAP
AG5	1 1/4 - 2" AIR GAP
AG11	1" 375 AIR GAP
1-S	1 1/2" Y Strainer



Wilkins 950 XL DCA

Model	Description
950 3/4"	3/4"
950 1"	1"
950 1 1/4"	1 1/4"



Wilkins 975 XL RPZA

Model	Description
975XL 3/4"	3/4"
975XL 1"	1"
975XL 1 1/4"	1 1/4"
975XL 1 1/2"	1 1/2"
975XL 2"	2"



Wilkins 375 RPZA

Model	Description
375 3/4"	3/4"
375 1"	1"
375 1 1/4"	1 1/4"
375 1 1/2"	1 1/2"
375 2"	2"
375 3"	3"

All of the previous Backflow devices are standard REAMS stocking items. If there is a certain model or size not listed here that you are interested in, please contact your local REAMS Representative for price and availability.



www.reams.net

Backflow Preventer Enclosure



R-Box	
Model	Description
BF 2922	29 x 22" Cover
BF 3015	30 x 15"
BF 4115	41 x 15"
BF 5025	50 x 25"



Mock Rock	
Model	Description
102FS	33"L x 26"W x 25"H - Gray
102RB	33"L x 26"W x 25"H - Brown
103FS	56"L x 42"W x 30"H - Gray
103RB	56"L x 42"W x 30"H - Brown

Brass Fittings

Street 90°	
Model	Description
BF 0077107	3/4"
BF 0107107	1"

Tee (CTS x CTS x Fipt)	
Model	Description
BF 0071444	3/4"
BF 0101444	1"

Compression Adapter (JJ)	
Model	Description
BF 0072605	3/4"
BF 0102605	1"

Tee	
Model	Description
BF 0077111	3/4"
BF 0107111	1"

Compression Coupling (JJ)	
Model	Description
BF 0072609	3/4"
BF 0102609	1"

Compression Tee (JJ)	
Model	Description
BF 0072617	3/4"
BF 0102617	1"

Nipple	
Model	Description
BF 3/4X3/4	3/4 MHT x 3/4 Mipt
BF 6220075	3/4" x Close
BF 6220100	1" x Close

90° Ell (Mipt)	
Model	Description
BF 0072619	3/4"
BF 0102619	1"

Coupling	
Model	Description
BF 0077101	3/4"
BF 0107101	1"

Adapter	
Model	Description
BF 0077104	3/4"

Combination Tee	
Model	Description
BF 1311334	3/4 CTS x CTS x 1" Fipt
BF 1311570	3/4 x 3/4 x 1" Flared Tee
BF 1312617	3/4 x 3/4 x 1" Comp Tee

PVC Cement & Primer



PVC-05 Clear Cement

Model	Description
PVC05C-020	PVC-05 Pint
PVC05C-030	PVC-05 Quart

Clear Medium Bodied Cement for PVC pipe and fittings up to 6". Medium Set.

PVC-25 Aqua Blue Wet-N-Dry Cement

Model	Description
PVC25B-020	PVC-25 Pint
PVC25B-030	PVC-25 Quart

Medium Bodied, very fast setting PVC Cement for PVC pipe fittings up to 6". Works in temps -15°F to 110°F.

PVC-27 Clear Cold-N-Hot Cement

Model	Description
PVC27C-020	PVC-27 Pint
PVC27C-030	PVC-27 Quart

Medium Bodied, very fast setting PVC Cement for PVC pipe fittings up to 6". Works in temps -15°F to 110°F.

PVC-50 Hot Blue PVC Cement

Model	Description
PVC50B-020	PVC-50 Pint
PVC50B-030	PVC-50 Quart

Medium Bodied, very fast setting, high strength PVC Cement for PVC pipe fittings up to 6". Hot Blue premium all-weather formulation is excellent for use in challenging conditions including wet, damp or cold temps.

PRIMER-68 Clear Primer

Model	Description
PRIM68C-020	PRIM-68 Pint
PRIM68C-030	PRIM-68 Quart

Essential for proper softening and preparation of PVC Pipe and Fittings.

PRIMER-68 Purple Primer

Model	Description
PRIM68P-020	
PRIM68P-030	

Essential for proper softening and preparation of PVC Pipe and Fittings. Purple color provides positive identification that a primer was used.



PVC Primer

Christy's Red Hot Blue Glue

Model	Description
PC 6380005	1/2 Pint
PC 6380050	Pint
PC 6380010	Quart



All Weather, Wet Conditions Hot Blue PVC Cement. Effective temp. range 10°F to 100°F. Fast Setting



IPS Cement

Model	Description
10166	Wet/Dry Pt.
10165	Wet/Dry Qt.
10990	Turf N' AG Pt.
10989	Turf N' AG Qt.



All Weather, Wet Conditions Hot Blue PVC Cement. Effective temp. range 10°F to 100°F. Fast Setting



Accessories

Model	Description
KT 47100	King Tote-N-Fill
PC DAUB-PT	Dauber - Pint Size
PC DAUB-QT	Dauber - Quart Size
10015	Pint Can Only - No Cap
10012	Quart Can Only-No Cap
31250	Quart Can Carrier
10008	7" Roller

Red Hot Primer

Model	Description
PC 6390010	Quart

Clamps

Clamps

Model	Description
1550009	170R - for Brown Drip and Swing Fitting
15500010	185R
KSCS-198	198R - Swing Pipe
KSCS-210	210R - 1/2" Poly
15500013	226R - 1/2" Aquapore
KSCS-256	256R - 3/4" Poly
KSCS-271	271R - 3/4" Poly
15500017	286R
KSCS-316	316R - 1" 3408
KSCS-331	331R - 1" 2406
KSCS-410	410R - 1 1/4" 3408
KSCS-425	425R - 1 1/4" 2406
KSCS-485	485R - 1 1/2" 2406
15500040	620R - 2" Poly



Oetiker Step-less Clamp

Model	Description
425-908	042.5-908 RD
485-908	048.5-908 RD
620-908	620-908 RD
331-908	331.1-908R

Screw Clamp

Model	Description
H8SS	1/2"
H12SS	3/4"
H16SS	1"
H20SS	1" - 1 1/4"
H24SS	1 1/4"
H28SS	1 1/2"
H32SS	2"
H40SS	2" - 3"

Compression Fittings

Compression Coupler

Model	Description
0110-05	1/2"
0110-07	3/4"
0110-10	1"
0110-12	1 1/4"
0110-15	1 1/2"
0110-20	2"
0110-25	2 1/2"
0110-30	3"
0110-40	4"
0110-60	6"



Compression Tee

Model	Description
PF 0120-07	3/4" GSK x Fipt
PF 0120-10	1" GSK x Fipt
PF 0220-07	3/4" G x F CTS
PF 0220-10	1" G x F CTS



Aluminum Compression Wrench

Model	Description
W00-25	2 1/2" Wrench
W00-30	3" Wrench
W00-40	4" Wrench
W00-60	6" Wrench



Flo Span Repair Coupling

Flo Span

Model	Description
S118-05	1/2"
S118-07	3/4"
S118-10	1"
S118-12	1 1/4"
S118-15	1 1/2"
S118-20	2"
S118-25	2 1/2"
S118-30	3"
S118-40	4"
S118-60	6"



Flo Span-Short

Model	Description
SH118-10	1"
SH118-12	1 1/4"
SH118-15	1 1/2"
SH118-20	2"

Flo Span w/Coupler

Model	Description
S119-10	1"
S119-12	1 1/4"
S119-15	1 1/2"
S119-20	2"
S119-25	2 1/2"
SH119-10	1" Short

Flo-Spans are a telescoping repair coupling for use on PVC Pipe Repairs.

REAMS

www.reams.net

Controllers - Hunter

X-Core Controller

Model	Description
XC400I	4 Station Indoor
XC600	6 Station Outdoor
XC600I	6 Station Indoor
XC800	8 Station Outdoor
XC800I	8 Station Indoor



Entry-level residential controller with extra flexibility, features, and memory. Available in a battery operated model.

Pro-C Modular

Model	Description
PC300I	3 Station Indoor
PC300	3 Station Outdoor
PCM300	3 Station Module
PCM900	9 Station Module



A complete family of modular, full-featured residential and light commercial controllers. 3 Station base with room to expand to 15 stations.

XC Hybrid Controller

Model	Description
XCH400	4 Station Indoor/Outdoor
XCH600	6 Station Indoor/Outdoor
XCH800	6 Station Indoor/Outdoor
XCH1000	8 Station Indoor/Outdoor
XCH1200	8 Station Indoor/Outdoor



XC Hybrid operates DC latching solenoids with battery power. For outdoors or indoors.

PCC Conventional

Model	Description
PCC600	6 Station Outdoor
PCC600I	6 Station Indoor
PCC900	3 Station Outdoor
PCC900I	9 Station Indoor
PCC1200	12 Station Outdoor
PCC1200I	12 Station Indoor
PCC1500	15 Station Outdoor
PCC1500I	15 Station Indoor



Same common features as the Pro-C Modular but in a fixed station set up coming in 6, 9, 12, 15 stations. Designed for Solar Sync installation inside cabinet.

I-Core Controller

Model	Description
IC600PL	6 Station Plastic Cabinet
ICM600	6 Station Metal Cabinet
IC600PP	ICC 6 Station Plastic Pedestal
DUAL48M	Dual Decoder Output Module

Designed for demanding commercial and high-end residential applications, the full-featured I-Core controller is easy to use, easy to install, and easy to program, with a variety of new features that will redefine irrigation intelligence. Plastic is expandable from 6 to 30 stations and the Metal is expandable to 42

Hunter®



REAMS

www.reams.net

Controllers - Hunter

Hunter®

NODE

Model	Description
NODE100	NODE Single Station w/ DC Latching Solenoid
NODE200	NODE 2 Station
NODE400	NODE 4 Station
NODE600	NODE 6 Station
NODE-100-VALVE	Single Station with PGV-101G Valve
DCSOL	DC Latching Solenoid



Node Controllers are a reliable battery-powered control without



WVC

Model	Description
WVC200	2 Station Valve Controller
WVC400	4 Station Valve Controller
WVP	Wireless Valve Programmer
HTDC	Latching Solenoid

Rugged, reliable, multi-station, multi-function, battery-powered controller and programmer.

Hunter Remotes

Model	Description
SRRSCWH	25' of Shielded Cable
ICRTR	ICR Transmitter
ICRR	ICR Receiver
ROAM	Roam Remote
ROAM-XL	Roam Remote Long Range up to 2 Miles



Reliable and powerful long-range, multi-site remote controls. ROAM for residential and light commercial, ICR for commercial and longest distances.

Flow-Clik™ Flow Sensor

Model	Description
FLOWCLIK	1 1/2" Male NPT Inlet & Outlet
FLowsync	Impeller Type Flow Meter
FCT	Pipe Installed Flow Fitting



Automatically shuts down system if an overflow condition occurs.



ET System

Model	Description
ETSYSTEM	ET Sensor for with Outdoor Interface ET Module
ETWIND	Anemometer for Wind Speed

Gathers weather data on site, continuously self-adjusts to calculate the ideal program for your landscape. Easily upgrades most Hunter controllers to weather-based control.

REAMS

www.reams.net

Controllers - Hunter



Hunter®

Solar Sync

Model	Description
SOLARSYNC	ET Module
WSS	Wireless Solar Sync

Continually gathers on-site solar and temperature data used in the calculation on ET, then determines watering requirements. Works with X-Core, I-Core, ACC, and Pro-C Controllers.



ACC

Model	Description
ACCCOM-GSM	Comm Mod. For GSM Cellular
ACCCOM-POTS	Comm Mod. For ACC Dialup
ACCPED	Metal Ped for ADD1200
ACC1200	Advanced Comm. Controller
ACM600	6 Station ACC Module
HFS	Flow Sensor for ACC

Hunter's most powerful controller for command of large and sophisticated sites. Also available in a two-wire decoder version.

IMMS 3.0 Central Control

Model	Description
IMMSCIHW	Controller Interface Unit
IMMSSIHW	Site Interface Unit—HW
IMMSSIMO	Site Interface Unit—Phone
IMMSCCC	Central Computer Com Unit
IMMSCD	Central Control Software

The affordable water management system to monitor and control a network of irrigation systems from a single central location



REAMS

www.reams.net

Controllers - Irritrol

Rain Dial



Model	Description
RD600INT-R	6 Station Indoor
RD900INT-R	9 Station Indoor
RD1200INT-R	12 Station Indoor
RD600EXT-R	6 Station Outdoor
RD900EXT-R	9 Station Outdoor
RD1200EXT-R	12 Station Outdoor

This advanced-design hybrid controller provides exceptional scheduling flexibility to accommodate a wide variety of landscape applications.

Smart Dial



Model	Description
SD1200EXT	12 Station Outdoor
SD1200INT	12 Station Indoor
SD1200MOD	12 Station Mod Only
SD2400EXT	24 Station Outdoor
SD600EXT	6 Station Outdoor
SD600INT	6 Station Indoor
SD600MOD	6 Station Mod Only
SD900EXT	9 Station Outdoor
SD900INT	9 Station Indoor
SD900MOD	9 Station Mod O
SDANT	Smart Dial Antenna

This WeatherTRAK enabled controller uses daily ET values to adjust watering times to meet the specific needs of each landscape area for the ultimate in water management.



Total Control

Model	Description
TC6-INB	6 Station Indoor
TC6-EXB	6 Station Outdoor
TC9-INB	9 Station Indoor
TC9-EXB	9 Station Outdoor
TC12INB	12 Station Indoor
TC12EXB	12 Station Outdoor
TC15EXB	15 Station Outdoor
TC18EXB	18 Station Outdoor
TC24EXB	24 Station Outdoor

Maximum scheduling flexibility in an easy-to-use format makes this innovative controller ideal for a wide range of sophisticated watering requirements.



PC Control

Model	Description
PCR	PC Controller Remote
PC12ADDEXRT	12 Station Outdoor Add On
PC12ADDINT	12 Station Indoor Add On
PC12INTPAK	PC Control Indoor Combo

The newest concept in irrigation control lets you manage your irrigation system from your computer!

Climate Logic Control

Model	Description
CL-100-WIRELESS	Wireless Weather Sensing System

Consisting of a wireless transmitting weather sensor for installation outdoors and a receiver module to attach to the Irritrol controller. The system monitors weather data, transmits them to the module and then alters the controller's program based on the weather.



Controllers - Rain Bird

ESP 4ME / 4MEI Modular Controller



Model	Description
ESP4ME	4 Station Outdoor
ESP4MEI	4 Station Indoor
SM3	3 Station Module
SM6	6 Station Module

4 station modular irrigation controller with three independent programs, easily expands up to 22 stations with the addition of 3 or 6 station plug-in modules

ESP LX Modular



Model	Description
ESPLXME	8 Station Outdoor
ESPLX MSM4	4 Station Module
ESPLXMSM8	8 Station Module
ESPLXMSM12	12 Station Module

Smart Features. Smart Cartridges. Smart Choice. This 4 program modular controller easily expands up to 32 stations with hot-swappable modules in four- or eight-station increments.

LIMR Remote



Model	Description
LIMR-KIT	Remote Kit
LIMR-TX	LIMR Transmitter
LIMR-RX	LIMR Receiver
LIMR-QC503	5 Pin, 3ft. Cable
LIMR-QC530	5 Pin, 30ft. Cable
LIMR-QC603	6 Pin, 3ft. Cable
LIMR-QC630	6 Pin, 30ft. Cable

1.5 Mile Range remote for Rain Bird Controllers. Remote enables user to run a system, run a program, activate zones, and skip to any zone by entering its number.

ESP-RZX Indoor Controller



Model	Description
RZX4I	4 Station Indoor
RZX6I	6 Station Indoor
RZX8I	8 Station Indoor

The ESP-RZX Controller was designed with ease of use in mind. Zone-based scheduling allows every valve to be scheduled independently; no more explaining "programs" to end users, eliminating call-backs. The large LCD screen shows all of the programming for each zone at the same time. Simple graphic based user interface is easy to explain and presents every controller feature at your fingertips.

ESP 4M / 4MI Modular Controller



Model	Description
ESP4M	4 Station Outdoor
ESP4MI	4 Station Indoor
SM3	3 Station Module

4 station modular irrigation controller with three independent programs, easily expands up to 13 stations with the addition of 3 station plug-in modules

ESP SMT Smart Controller



Model	Description
ESPSMT4	4 Station Outdoor
ESPSMT4I	4 Station Indoor
ESPSMTUPG	Upgrade Kit

Combining the proven simplicity of the Extra Simple Programming (ESP) controller family with the accuracy of weather-based control, this innovative system is engineered to save valuable time, money and water.

REAMS

www.reams.net

Controllers - Rain Bird

TBOS

Model	Description
TBOSFTS	TBOS Field Transmitter
TBOS-1	TBOS 1 Station Module
TBOS-2	TBOS 2 Station Module
TBOS-4	TBOS 4 Station Module
TBOSRAIN	TBOS Rain Shutoff
TBOSPLIP	TBOS Plip Remote
TBOSSOL	DC Latching Solenoid



TBOS battery-operated line of buriable controllers allows the use of automatic irrigation in the absence of AC power.



ET Manager

Model	Description
ETMI	ET Man. Receiver Ind.
ETMIANT	Remoter Antenna Kit
ETMIOE	Outdoor Enclosure ET
ETMPS	ET Manager Software
ETMRG	Tipping Bucket Rain
ETMWRSS	Weather Reach Server Software
ETCLX	ET Man. Control Cartridge for LX

Works with virtually any controller, converting a conventional irrigation system into a weather-smart one that adjusts itself according to accurate real-time weather data.

Pedestals

Model	Description
PED-DD16	For ESP-MC, ESP-SAT, & CCU
LXMMPED	ESP-LX Series - Metal Pedestal
LXMM	ESP-LX Series - Metal Cabinet



Metal cabinets and pedestals are not standard on ESP-LX Series controllers and must be purchased separately.

IQ v2.0 Central Control

Model	Description
IQSTARTCD	Base Software Package, 5 Satellite Capacity
IQSSATSWU	Software 5-Satellite Capacity Upgrade
IQACOMFP	Advanced Communications Feature Pack
IQAPGMFP	Advanced Programming Feature Pack
IQAFSENF	Advanced Flow Sensing Feature Pack
IQNCC-GP	GPRS/Cellular Cartridge
IQNCC-WF	WiFi Cartridge
IQFSCM-LXME	Flow Smart Connection Module



More power. More flexibility. IQ™ v2.0 Central Control Software offers state-of-the-art command and control features in an easy to learn and use interface. IQ provides advanced water management features saving money and time. IQ Software has modular satellite controller capacity and features. Purchase only what you need today and upgrade as your needs change in the future.

REAMS

www.reams.net

2-Wire Controllers

ACC Controller

Model	Description
ACCPED	Metal Ped ACC1200
ACC99D	ACC Decoder Con.
ACC99DPP	ACC Decoder Contr W/Ped Plas
ICD100	1 Station Decoder
ICD200	2 Station Decoder
ICD400	4 Station Decoder
ICD600	6 Station Decoder
ICDSD	Decoder Sensor
ICDHP	Handheld Decoder Programmer



Hunter®



The two-wire decoder version of Hunter's most powerful controller for command of large and sophisticated sites.



ICD-HP

Model	Description
ICDHP	ICD Handheld Programmer

This industrial grade outdoor instrument saves installation and diagnostic time, and helps you get even more out of your Hunter decoder systems. Using innovative wireless induction, the ICD-HP permits a full range of programming, diagnostic and operational features without removal of waterproof connectors.

The programmer's induction probe communicates with Hunter decoders through the decoder case - wirelessly.



Dual Module for I-Core

Model	Description
DUAL48M	Dual Decoder Output Module
DUAL-1	Dual 1 Station Decoder
DUAL-2	Dual 2 Station Decoder
DUAL-S	Dual Surge Arrestor

The module is what makes it Dual. Simply install the DUAL48M module to any I-Core, and your controller is now two-wire ready. With a capacity of up to 48 stations, I-Core Dual is able to be customized for any size job.



REAMS

www.reams.net

2-Wire Controllers



MDC Decoders

MDC 2-Wire Decoder

Model	Description
FD101	FD101 Turf Signal
FD102	FD102 Turf Signal
FD202	FD202 Turf Signal 2 Valve
FD401	FD401 Turf Signal 4 Valve
FD601	FD601 Turf Signal 6 Valve
MDCM50D	MDC-50 Decoder Exp Mod
MDC200	MDC-200 Controller
MDC50200	MDC50200 2-Wire Controller



The World's Most Surge-Resistant Two Wire Decoder System



ESP-LXD 2 Wire Decoder Controller

Model	Description
ESPLXD	ESPLX Modular Controller
LXDSM75	75 Station 2 Wire Module
LXMM	Metal Case for LX
LXMMPED	Metal Pedestal for LX
PCBLXD	Program Backup Cartridge

The ESP-LXD controller has been designed to maintain the look, feel and ease of programming of the ESP-LXM controller but with an interface to a two-wire path for decoder-based irrigation. The ESP-LXD controller can manage up to 50 stations but can easily be expanded for use with up to 200 stations. Flow Management is also built in to every ESP-LXD controller.



ZWIRE™ Universal Decoder Module
 • Converts ANY Controller to 2-wire.
 • 1 to 63 stations



ZWIRE™ ICC Decoder Module
 • Converts Hunter® ICC Controller to 2-wire.
 • 1 to 48 stations



ZWIRE™ Decoder
 • 1 decoder per station
 • No grounding necessary

Underhill 2-Wire

Model	Description
TWUNI63	Universal Decoder Module
TWICC48	ICC Decoder Module
TWTKDEC1	2Wire Decoder
2WIREPROG	Programmer

Underhill 2Wire Decoder Irrigation Control Systems for Any Controller



www.reams.net

Copper Fittings

Coupler

Model	Description
10030900	1/2" C x C
10030904	3/4" C x C
10030908	1" C x C
10030716	3/4 x 1/2" Red
10030734	3/4 x 1" Red

Union

Model	Description
10033585	3/4"
10033584	1"

Female Adapter

Model	Description
10030150	3/4"
10030160	1"
10030156	3/4 x 1/2"
10030154	3/4 x 1" Red

Male Adapter

Model	Description
10030310	1/2"
10030330	3/4"
10030342	1"
10030336	3/4 x 1" Red
10030348	1 x 3/4" Red

90° Ell

Model	Description
10031272	1/2" C x C
10031288	3/4" C x C
10031296	1" C x C
10031408	3/4" Fipt x C
10031412	1" Fipt x C
CF 4070131	3/4 x 1" c x Fipt

Tee

Model	Description
10032768	3/4" C x C x C
10032818	1" C x C x C
10032856	1 x 1/2 x 1 C x C x C
10037429	1 x 1 x 1/2 C x C x C
10032770	3/4 x 3/4 x 1" Combo Tee

Solder & Paste

Model	Description
097160	Wire Solder - 95/5 Lead Free
097205-12	Soldering Paste - 1.7 oz
097455-12	Solder Paste 8 oz

45° Ell

Model	Description
10031106	3/4"
10031120	1"

Accessories

Model	Description
092030	Copper Fitting Brush 3/4"
095705	Sandcloth Open Mesh 5 yd

Copper Tube

Type M

Model	Description
COPM0510	1/2" x 10'
COPM0710	3/4" x 10'
COPM1010	1" x 10'

Type K

Model	Description
COPK0510	1/2" x 10'
COPK0710	3/4" x 10'

Type K Soft

Model	Description
COPK071S	3/4" x 1'
COPK0760S	3/4" x 60'
COPK101S	1" x 1'



www.reams.net

Drain Tile / Fittings - ADS

ADS 3" Pipe

Model	Description
3S-100	3" Non-Perf - 100'
3P-100	3" Perf - 100'

ADS 4" Pipe

Model	Description
4S-100	4" Non-Perf - 100'
4S-250	4" Non-Perf - 250'
4P-100	4" Perforated - 100'
4P-250	4" Perforated - 250'
4PS-100	4" Perf w/Sock - 100'
4PS-250	4" Perf w/Sock - 250'

ADS 6" Pipe

Model	Description
6S-100	6" Non-Perf - 100'
6P-100	6" Perforated - 100'

ADS Dual Wall

Model	Description
0495	4" Solid by the foot
0695	6" Solid by the foot

EZ Flow Pipe

Model	Description
EZ-1001F	10" Mesh w/ 4" Pipe
EZ-0701F	7" Mesh w/3" Pipe

EZflow Pre-Engineered French Drains eliminate the need for gravel, install in half the time, and reduce labor costs by 50% or more.



Coupler

Model	Description
312AA	3" Snap Coup
415AA	4" Internal Coup
612AA	6" Snap Coup
314AA	4 x 3" Red Coup
614AA	6 x 4" Red Coup
816AA	8 x 6" Red Coup



Tee

Model	Description
321AA	3" Snap Tee
421AA	4" Snap Tee
626AA	6" Snap Tee



EII

Model	Description
390AA	3" EII
490AA	4" EII



"Y"

Model	Description
322AA	3" "Y"
422AA	4" "Y"



Cap

Model	Description
332	3" Snap Cap
432	4" Snap Cap



Downspout Adapters

Model	Description
364AA	3" DSA
464AA	4" DSA - Residential
465AA	4" DSA - Comm



Stealth Spout

Model	Description
4101	Tapered Drain End
4201	12" Extension
4401	Flex Grate Adapter
4621	Adapter w/Extension

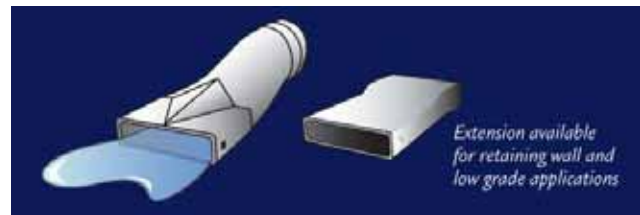

Drainage Products



Catch Basin

Model	Description
900	9 x 9" Catch Basin
900-4	9 x 9" Basin - 4 Openings
1200BKIT	12" x 12" Kit
1200NGB	12" x 12" Catch Basin
1203	12 x 12" Basin - 3 Openings
1204	12 x 12" Basin - 4 Openings
1882	18 x 18" Catch Basin



9 x 9 Deep Housing Spigot Adapter

Model	Description
931	9 x 9" Spigot Adapter



Spee-D Basins

Model	Description
101	Single Outlet
201	Double Outlet
250	Double Outlet - 90°
350	4 Outlets

Round Grates

Model	Description
14	3" Grate - Black
13	4" Grate - Green
11	4" Grate - Black
12	4" Grate - Gray
40	6" Grate - Black
50	6" Grate - Green
10	8" Grate - Black
20	8" Grate - Green
1050	10" Grate - Green



Catch Basin Riser Ext.

Model	Description
916	9 x 9 - 6" Riser Extension
1216	12 x 12 - 6" Riser Ext.



Low Profile Adapter

Model	Description
930	9 x 9" Adapter
1230	12 x 12" Adapter

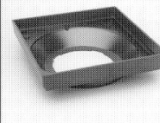

12 x 12" Adapter w/8" Outlet

Model	Description
1221	12 x 12" - w/8" Outlet

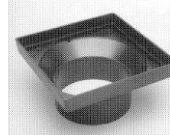

Atrium Grates

Model	Description
75	4" Atrium Grate - Green
80	6" Atrium Grate - Green

Square Grates

Model	Description
07	5" Square Grate - Green
04	6" Square Grate - Black
05	6" Square Grate - Green
772	7" Square Grate - Green
950	9" Square Grate - Green
970	9" Square Grate - Black

Drainage Products



6 x 6" Adapter w/Grate

Model	Description
640	6 x 6" Adapter w/Grate

Square Grate

Model	Description
980	9 x 9" Square Grate - Black
990	9 x 9" Square Grate - Green
999	9 x 9" Square Grate - Gray
1210	12 x 12" Grate - Gray
1211	12 x 12" Grate - Black
1212	12 x 12" Grate - Green
1811	18 x 18" Grate - Black
1812	18 x 18" Grate - Green

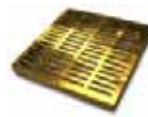

Atrium Grates

Model	Description
981	9 x 9" Atrium Grate - Black
991	9 x 9" Atrium Grate - Gray
1280	12 x 12" Grate - Green
1290	12 x 12" Grate - Black

Steel/Cast Iron Grate

Model	Description
1215	12 x 12" Steel Grate
1815	18 x 18" Steel Grate
1213	12 x 12" Cast Iron Grate

Universal Plug & Outlet

Model	Description
1206	6" Universal Plug
1243	3" & 4" Universal Outlet
1266	6" Universal Outlet
1888	8" Universal Outlet



Flo Well

Model	Description
FWAS24	24 x 28 75 Flo Well
FWAS24C	24" Round Flo Well Cover
FWSD69	Flo Well Surface Inlet
FWSPS3	Flo Well Side Panels
FWBP24	Flo Well Bottom Panel



Water discharges into the subsoil rapidly and easily.

Pop-Up Drainage Emitter

Model	Description
TT155	Pop-up Emitter 3", 4"
TT156	Pop-up Emitter ONLY



REAMS

www.reams.net

Drainage Products

Mini & Spee-D Channel System Components

1. Channel
2. Grate
3. Coupling
4. End Cap or End Outlet
5. Channel Bottom Outlet
6. Sewer & Drain Fitting
7. Drain Pipe

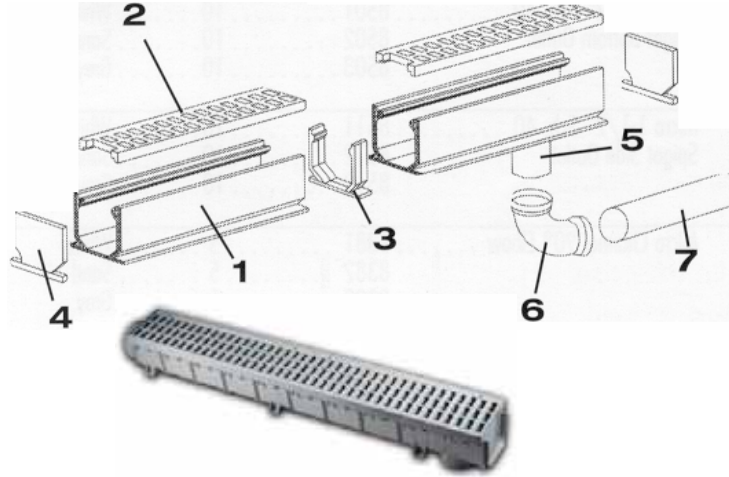

Grates, Tees, Elbows, and Crosses are available in the following colors:

- White
- Gray
- Green
- Black
- Sand
- Brick Red

Mini Channel

Model	Description
500	6' Channel Drain - Gray
541	3' Channel Grate - Gray
548	Coupling
547	End Cap
546	2" End Outlet
550	3' Channel w/2" Outlet
529	Stainless Steel Screws

Spee-D Channel

Model	Description
400	4' Channel Drain
400-10	10' Channel Drain
241	2' Channel Grate - Gray
248	Coupling
247	End Cap
234	3" & 4" Bottom Outlet
229	Stainless Steel Screws

Ask your local REAMS Representative for a Catalog of the Entire Line of Channel Drainage Products!!!!

REAMS

www.reams.net

Drainage Products

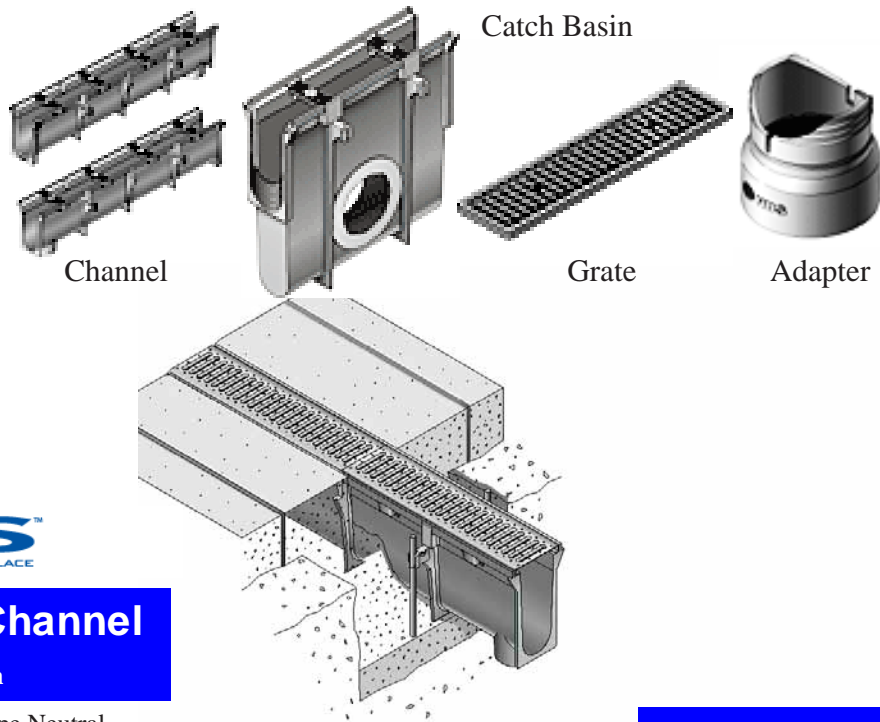

Dura Slope Channel

Model	Description
DS090N	4' Dura Slope Neutral
DS091	4' Dura Slope Channel
DS092	4' Dura Slope Channel
DS093	4' Dura Slope Channel
DS094N	4' Dura Slope Neutral
DS094	4' Dura Slope Channel
DS095	4' Dura Slope Channel
DS096	4' Dura Slope Channel
DS097N	4' Dura Slope Neutral
DS097	4' Dura Slope Channel
DS098	4' Dura Slope Channel
DS099	4' Dura Slope Channel
DS100N	4' Dura Slope Neutral
DS100	4' Dura Slope Channel
DS101	4' Dura Slope Channel
DS102	4' Dura Slope Channel
DS103N	4' Dura Slope Neutral

Dura Slope Channel

Model	Description
DS103	4' Dura Slope Channel
DS104	4' Dura Slope Channel
DS105	4' Dura Slope Channel
DS106	4' Dura Slope Channel
DS107	4' Dura Slope Channel
DS108	4' Dura Slope Channel
DS109N	4' Dura Slope Neutral
DS109	4' Dura Slope Channel
DS110	4' Dura Slope Channel
DS111	4' Dura Slope Channel
DS112N	4' Dura Slope Neutral
DS112	4' Dura Slope Channel
DS113	4' Dura Slope Channel
DS114	4' Dura Slope Channel

Dura Slope Grates

Model	Description
DS200	Ductile Iron Frame
DS231	Cast Iron Grate
DS232	Ductile Iron Grate
DS661LG	Plastic Grate-Gray

Dura Slope Misc.

Model	Description
DS123	Frame/End Cap Screws-12
DS126	Bottom Outlet
DS224	End Cap
DS225	Grate Screws for Frame-1
DS227	End Outlet
DS240	Trash Bucket
DS340	Catch Basin
NDS629	Grate Screws

Drainage Products - Sewer & Drain

PVC Sewer & Drain Pipe



Model	Description
2729-4-P	4" Perforated
2729-6-P	6" Perforated
2729-3-S	3" Solid
2729-4-S	4" Solid
2729-6-S	6" Solid

S&D Coupler



Model	Description
3P05	3" HUB x HUB
4P05	4" HUB x HUB
6P05	6" HUB x HUB

S&D Wye



Model	Description
3P08	3" HUB x HUB x HUB
4P08	4" HUB x HUB x HUB
6P08	6" HUB x HUB x HUB

S&D Downspout Adapters



Model	Description
9P03	2"x3"x3" Offset
9P04	2"x3"x4" Offset
9P06	3"x4"x4" Offset
9P10	4"x6"x6" Offset



S&D Tee

Model	Description
3P01	3" HUB x HUB x HUB
4P01	4" HUB x HUB x HUB
6P01	6" HUB x HUB x HUB



S&D 90° Elbow

Model	Description
3P02	3" 90° HUB x HUB
4P02	4" 90° HUB x HUB
6P02	6" 90° HUB x HUB



S&D 45° Elbow

Model	Description
3P03	3" 45° HUB x HUB
4P03	4" 45° HUB x HUB
6P03	6" 45° HUB x HUB



S&D Reducer Coupling

Model	Description
4P07	4" x 3" HUB x HUB
6P07	4" x 6" HUB x HUB
8P07	6" x 8" HUB x HUB



S&D Cap

Model	Description
3P06	3"
4P06	4"
6P06	6"

Drip Irrigation - Hunter

Hunter®



PLD 17MM Drip Tubing

Model	Description
PLD0412100	12" Spacing@.04GPH - 100' Roll
PLD0412250	12" Spacing@.04GPH - 250' Roll
PLD0412K	12" Spacing@.04GPH - 1000' Roll
PLD0418100	18" Spacing@.04GPH - 100' Roll
PLD0418250	18" Spacing@.04GPH - 250' Roll
PLD0418K	18" Spacing@.04GPH - 1000' Roll
PLD0424100	24" Spacing@.04GPH - 100' Roll
PLD0424250	24" Spacing@.04GPH - 250' Roll
PLD0424K	24" Spacing@.04GPH - 1000' Roll
PLD0612100	12" Spacing@.06GPH - 100' Roll
PLD0612250	12" Spacing@.06GPH - 250' Roll
PLD0612K	12" Spacing@.06GPH - 1000' Roll
PLD0618100	18" Spacing@.06GPH - 100' Roll
PLD0618250	18" Spacing@.06GPH - 250' Roll
PLD0618K	18" Spacing@.06GPH - 1000' Roll
PLD0624100	24" Spacing@.06GPH - 100' Roll
PLD0624250	24" Spacing@.06GPH - 250' Roll
PLD0624K	24" Spacing@.06GPH - 1000' Roll
PLDBLNK100	100' Blank Roll no Emitters
PLDBLNK250	250' Blank Roll no Emitters

Zone Control Kits

Model	Description
ICZ-101-25	1" ICV Valve w/1" HY100 Filter w/25 psi regulator
ICZ-101-40	1" ICV Valve w/1" HY100 Filter w/40 psi regulator
PCZ-101-25	1" PGV Valve w/1" HY100 Filter w/25 psi regulator
PCZ-101-40	1" PGV Valve w/1" HY100 Filter w/40 psi regulator

Convenient and reliable solutions for automatic control of a drip zone.



PLD Fittings

Model	Description
PLDCAP	Barb to End Cap
PLDBV	Barbed Ball Valve
PLD050	Barb to 1/2"NPT Adapter
PLD075	Barb to 3/4" NPT Adapter
PLDCPL	Barb to Barb Coupler
PLDELB	Barb to Barb Elbow
PLDTEE	Barb to Barb Tee

Makes fast water tight connections for the PLD Tubing

The new PLD applies water slowly and evenly for consistent distribution. It also incorporates a pressure compensation system with a built in check valve that helps prevent emitter clogging and water loss.



REAMS

www.reams.net

Drip Irrigation - Netafim



USA



Pressure Indication Stake

UNIRAM Heavy Wall Dripperline

Model	Description
08RAM.636	RAM 17MM .6 GPH 36" 1000'
08RAM624	RAM 17MM .6 GPH 24" 1000'
08VRAM424	RAM 17MM .4 GPH 24" w/clip
08VRAM430	RAM 17MM .4 GPH 30" w/clip
08VRAM436	RAM 17MM .4 GPH 36" w/clip
08VRAM636	RAM 17MM .6 GPH 36" w/clip
08VRAM648	RAM 17MM .6 GPH 48" w/clip
08VR16636	RAM 16MM .6 GPH 36" w/clip
08VR16648	RAM 16MM .6 GPH 48" w/clip
10F01	Line Pressure Indicator Stake



Techline Fittings

Model	Description
TLCOUPB	TL Insert Coupler
TLCROS	TL Insert Cross
TLDPLUG	TL Dripper Plug
TLELLB	TL Insert Elbow
TLSOV	TL Insert Shutoff BxB
TLTEEB	TL Insert Tee
TL050MAB	TL Insert M.A. 1/2"
TL050MFV	Flush Valve 1/2" MPT
TL075MAB	TL Insert M.A. 3/4"

Techline

Model	Description
TLCV001	TL CV Blank 100'
TLCV0025	TL CV Blank 250'
TLCV010	TL CV Blank 1000'
TLCV261210	TL .26 GPH 12" 1000'
TLCV261225	TL .26 GPH 12" 250'
TLCV41201	TL .40 GPH 12" 100'
TLCV412025	TL .40 GPH 12" 250'
TLCV91201	TL .90 GPH 12" 100'
TLCV912025	TL .90 GPH 12" 250'



REAMS

www.reams.net

Drip Irrigation - Rain Bird



Xeri-Pops™

Model	Description
XR XP400X	4" Pop-Up w/1/4" Barb
XR XP600X	6" Pop-up w/1/4" Barb
XR XP1200X	12" Pop-up w/1/4" Barb



Air Relief Valve Kit

Model	Description
ARVALVEKIT	Air Relief Valve Kit



XFD

Landscape Dripline - XFD

Model	Description
XFD0612100	12" Spacing - 100' Roll, .06gph
XFD0612500	12" Spacing - 500' Roll, .06gph
XFD0618100	18" Spacing - 100' Roll, .06gph
XFD0618500	18" Spacing - 500' Roll, .06gph
XFD0624500	24" Spacing - 500' Roll, .06gph



XFS

Landscape Dripline BLANK

Model	Description
XFD100	Dripline Blank - 100'
XFD500	Dripline Blank - 500'
CDT0501000	1/2" Black Drip Tube 1000'
CDT050250	1/2" Black Drip Tube 250'
CDT050500	1/2" Black Drip Tube 500'

Landscape Dripline - XFS

Model	Description
XFS0612100	12" Spacing - 100' Roll
XFS0612500	12" Spacing - 500' Roll
XFS0618100	18" Spacing - 100' Roll
XFS0618500	18" Spacing - 500' Roll
XFS0624500	24" Spacing - 500' Roll

Rain Bird's patent-pending Copper Shield Technology protects the emitter from root intrusion, creating a long-lasting, low maintenance sub-surface drip irrigation system for use under turf grass or shrub and groundcover areas.



1/4" Vinyl Distribution Tubing

Model	Description
XQ100	100' Coil
XQ250	250' Coil
XQ1000	1000' Coil
XQ1000B	1000' Coil in Bucket



1/4" Landscape Dripline

Model	Description
LDQ0806050	1/4" LDQ 1/4" .08 6"-50'
LDQ0806100	1/4" LDQ 1/4" .08 6"-100'
LDQ0812050	1/4" LDQ 1/4" .08 12"-50'
LDQ0812100	1/4" LDQ 1/4" .08 12"-100'

Rain Bird's 1/4" Dripline is a perfect choice for small-sized areas such as planter boxes, container gardens, loops around trees, vegetable gardens and shrubs.

Drip Irrigation - Rain Bird



Xeri-Bug™ Emitters

Model	Description
XB05PC	XB-05 0.5 GPH - Blue
XB10PC	XB-10 1.0 GPH - Black
XB20PC	XB-20 2.0 GPH - Red
XBT10	XBT-10 1.0 GPH
XBT20	XBT-20 2.0 GPH



Pressure Compensating Modules

Model	Description
PC05	PC-05 5.0 GPH - Lt. Brown
PC07	PC-07 7.0 GPH - Violet
PC10	PC-10 10.0 GPH - Green
PC12	PC-12 12.0 GPH - Brown
PC18	PC-18 18.0 GPH - White
PC24	PC-24 24.0 GPH - Orange

Mini-Outlet Xeri-Bug™

Model	Description
XB106	XB-10-6
XBT106	XBT-10-6 1/2" Fipt
EMT6X	EMT6 Xeri Outlet 1/2"



Xeri-Bird™ 8 Multi-Outlet Emission Device

Model	Description
XR 300BD80	Xeri-Bird™ - Blank

Xeri-Bubblers™

Model	Description
SXB180-025	SXB 180° Barb
SXB360-025	SXB 360° Barb
XR 403UXBF	UXB 180° Barb
SXB180-050	SXB 180° 1/2" FPT
SXB360-050	SXB 360° 1/2" FPT
UXB360-050	UXB 360° 1/2" FPT
SXB180	SXB 180° 10-32 Thread
SXB360	SXB 360° 10-32 Thread
UXB360	UXB 360° 10-32 Thread
SXB180SPYK	SXB 180° Spike
SXB360SPYK	SXB 360° Spike
UXB360SPYK	UXB 360° Spike



Xeri-Sprays™

Model	Description
XS090	XS 90° 10-32 Threads
XS180	XS 180° 10-32 Threads
XS360	XS 360° 10-32 Threads
XS360TS025	XS 360° True Spray Barb
XS360TS050	XS 360° True Spray 1/2" FPT
XS360TS	XS 360° True Spray 10-32
XS360TSPYK	XS 360° True Spray, 5" Spike



REAMS

www.reams.net

Drip Irrigation - Rain Bird

MD Fittings

Model	Description
MDCFCAP	Removable Cap
MDCFCOUP	MDF Coupler
MDCFEL	MDF Elbow
MDCFTEE	MDF Tee
MDCF50FPT	1/2" FPT Adapter
MDCF50MPT	1/2" MPT Adapter
MDCF75FHT	3/4" FHT Adapter
MDCF75FPT	3/4" FPT Adapter
MDCF75MPT	3/4" MPT Adapter

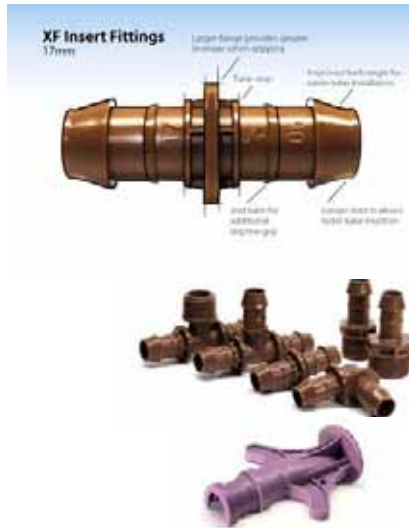

XFF 17MM Fittings

Model	Description
XFFCOUP	Barb Coupler
XFFELBOW	Barb Elbow
XFFMA050	Barb Male Adapter 1/2"
XFFMA075	Barb Male Adapter 3/4"
XFFTEE	Barb Tee
XFFTMA050	Tee Male Adapter 1/2"
XF TOOL	XF Insertion Tool

Less force is required to securely attach XFF fittings to 17MM Drip Pipe. This reduces hand fatigue and will save time and money.



1/4" Tubing Fittings

Model	Description
XBF1CONN	1/4" Coupler
XBF2EL	1/4" Ell
XBF3TEE	1/4" Tee
EMAGPX	Goof Plug
MC025	Mounting Clip

Retrofit Pressure Regulator

Model	Description
PRS05030	PRS-050-30 (30 psi)



Retrofit Kit

Model	Description
1800RETRO	1800 Retrofit Kit
1800XC	1800 Solid Cap



Xeri Pressure Compensating Nozzle

Model	Description
XPCNADP12	12" PFR PCN Adapter
XPCNFUL	Xeri PCN 360
XPCNHFLF	Xeri PCN 180
XPCNQTR	Xeri PCN 90



Galvanized Tie-Down Stake

Model	Description
TDS050Bend	Tie-Down Stake w/ Bend



Drip Irrigation - Rain Bird



Polyflex Riser /Adapter and Stake Assemblies

Model	Description
PFRFRA	12" Riser w/1/2" MPT
PFRRS	12" Riser and stake



12" Polyflex Riser

Model	Description
PFR-12	12" Polyflex Riser



10-32 Thread Adapter

Model	Description
1032A	10-32A Thread Adapter



Flex Riser Stake - Threaded

Model	Description
RS025T	RS-025 Riser Stake



1/4" Tubing Stake

Model	Description
TS025	TS-025 Tubing Stake
TS025WCAP	TS-025 with Cap



1800 Xeri-Bubbler Adapter

Model	Description
XBA1800	1800 Xeri-Bubbler Adapter



1/4" SPB Connector

Model	Description
SPB025	SPB-025 (Unrestricted flow)



Diffuser Bug Cap

Model	Description
DBC025	Diffuser Bug Cap



Xeri-Stake™

Model	Description
700XS050	700-XS-050 Xeri-Stake



Xeri-Micro Valves

Model	Description
XMV025	1/4" Barb x Barb
XMV1032	10-32 Thread

REAMS

www.reams.net

Drip Irrigation - Rain Bird



Inline Pressure Regulators

Model	Description
PSIL30X075	3/4" 30PSI
PSIM30X075	3/4" 30PSI
PSIM40X075	3/4" 40PSI
PSIM40X100	1" 40PSI



Tools

Model	Description
EMARBP	Hole Punch Tool
EMACTX	Replacement Tips
XF Tool	XF Fittings Tool
XMTOOL	Xeri Tool



Pres. Reg. & Filter

Model	Description
PRF075RBY	RBY 3/4" w/press. reg.
PRF100RBY	RBY 1" w/ press. reg.

Control Zone Kits

Model	Description
XCZ075PRFB	XCZ-075 3/4" Kit
XCZ100BCOM	1" Com. Control Kit
XCZ100PRFB	XCZ-100 1" Kit



Ductile Iron Fittings

90° EII

Model	Description
80320	3"
80420	4"
80620	6"

45° EII

Model	Description
80322	3"
80422	4"
80622	6"

Tee

Model	Description
8030306	3" x 3" x 6"
8040401	4" x 4" x 2"
8040404	4"
8040406	4" x 4" x 6"
8060306	6" x 3" x 6"
8060606	6"

Tapped Tee

Model	Description
804502	4" x 1"
804504	4" x 2"
806502	6" x 1"
806504	6" x 2"

Ask your REAMS representative about the entire line of ductile iron products!!!



www.reams.net

Electrical Products

Ground Rods

Model	Description
GR588	5/8" x 8' Ground Rod
GRE58	5/8" Ground Rod Clamp



Conduit

Model	Description
CON05	1/2" x 10' Conduit
CON07	3/4" x 10' Conduit
CON10	1" x 10' Conduit
LB05	Line Box 1/2"
LB07	Line Box 3/4"



Wall Anchor Devices

Model	Description
70102	Staples-Orange 100 units
ICM-2	Wall Anchor - Drywall
ICM-3	Wall Anchor - Masonry



6' Elec Cord w/Plug

Model	Description
PIGTAIL	6' Electrical Cord w/Plug



Valve Acces.

Model	Description
DOUBLER	Doubler

Enables you to run 2 valves on 1 wire by switching the valves each time that zone runs.

ISOLATOR	Isolator
RCO-860007	Chatter Box

Turns valve on and off to help you locate lost valve by sound.

RCO-860009	Add-A-Zone
------------	------------

Independently control 2 valves with 1 wire. This unit does not switch like the doubler.



Filters

Vu-Flow

Model	Description
NT100-100P	T Filter 1" 100 Mesh
NT100-140P	T Filter 1" 140 Mesh
NT150-60P	T Filter 1 1/2" 60 Mesh
NT150-100P	T Filter 1 1/2" 100 Mesh
NT200-100P	T Filter 2" 100 Mesh



Complete System Filtration with built in flush.

In-Line RBY Filters

Model	Description
RBY075MPTX	RBY 3/4" mpt x mpt
RBY100MPTX	RBY 1" mpt x mpt
RBY100MX	100 Mesh Filter ONLY



Automatic Filter Kit

Model	Description
AF100LS	AF100-LSS 1"
AF150LS	AF150-LSS 1 1/2"
AF200LS	AF200-LSS 2"



REAMS

www.reams.net

Fire Pits



Fire Rings

Model	Description
FRS18	18" SS Round
FRS24	24" SS Round
FRS30	30" SS Round
FRS36	36" SS Round



Staggered burner ports that are drilled not punched for better flame pattern.
 Fire rings also available in square and rectangular shapes.
 30", 36", & 48" round rings also available in high capacity.
 Available in natural gas or LP.

Fire Pit Kits - Match Lit

Model	Description
FPS24	24" SS Round Match Lit
FPS30	30" SS Round Match Lit
FPS36	36" SS Round Match Lit

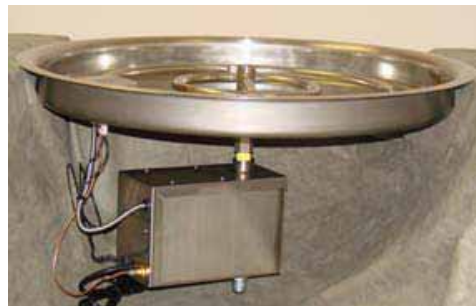

Kits come w/valve, nipples, fittings, & lava rock.
 Staggered burner ports that are drilled not punched for better flame pattern.
 Fire rings also available in square and rectangular shapes.
 30", 36", & 48" round rings also available in high capacity. Available in natural gas or LP.

Fire Pit Kits - Remote and Manual

Model	Description
25SS150 HSI	25" SS Bowl, 18" SS Round Ring, w/ 150k Btu. Remote electronic ignition
31SS150 HSI	31" SS Bowl, 24" SS Round Ring, w/ 150k Btu. Remote electronic ignition
FPPK24	24" SS Pan, 18" SS Round Burner. Manual Ignition.

There are many different models and variations of both the Electronic Ignition and Manual Push Button. For more information, refer to the Hearth Products Controls Catalog.

Fire Pit Accessories

Model	Description
FPSLPK	LP Conversion Kit
657	Lava Rock 1/2 cubic foot
FPL24C6	6 piece 24" campfire log set
317-12B	12" Brass Valve Key
317-18B	18" Brass Valve Key
MABB-HC	Brass Angle Valve Kit-High Capacity
FPGL-????	Decorative Glass per pound

Decorative glass is available in over 2 dozen colors!!!

For the complete line of Fire Rings and Fire Pit Accessories, please contact your local REAMS Representative!!!

REAMS

www.reams.net

Fountains & Aerators



Floating Fountains - J Series Multi Shaped Pattern

Model	Description
1400JF050	1/4HP 120V Single Phase w/50' cord
51JF250	5HP 240V Single Phase w/250' cord

Many sizes and styles of aerating fountains to fit the needs of your pond or lake. Quality units that both beautify your body of water with an elegant display pattern and provide valuable oxygen and agitation to promote a healthy pond or lake. Low overall operating costs. Fully-self contained and floats in place.



Floating Fountains - V Series V Shaped Pattern

Model	Description
2400VFX050	1/2HP 120V Single Phase w/50 cord
51VFX250	5HP 240V Single Phase w/250 cord

The V Series fountains have the same options as the J Series. 3 Phase also available.



Circulators

Model	Description
2400CF50	1/2HP 120V Single Phase w/50' cord
4400HCF250	1HP 240V Single Phase w/250' cord

Water circulators are ideal for creating directional water flow in your pond or lake. This transforms still, stagnant water into a stream environment and helps add vital oxygen. Several sizes available.



Aerators

Model	Description
2400AF050	1/2HP 120V Single Phase w/float & 50' cord
5.1AP250	5HP 240V Single Phase w/float & 250' cord

Aerators dramatically agitate high volumes of water at the surface to maximize exposure of water to the air for valuable gas exchange, greatly improving your pond or lake aeration. Several sizes available

Robust Aire Aquatic Aeration

Model	Description
RA1	1 Diffuser Assem. w/large cabinet, 100' of 3/8" Tubing, 120 Volt
RA2	2 Diffuser Assem. w/large cabinet, 200' of 3/8" Tubing, 120 Volt
RA3	3 Diffuser Assem. w/post cabinet, 300' of 3/8" Tubing, 120 Volt

No electricity in water, no floating equipment, no electricity needed at waters edge

Fountain Light Kit

Model	Description
LR275050	2 Light Kit w/50' cord
LR375250	3 Light Kit w/250' cord

Several sizes and models. Enhances the aesthetics of your pond or lake and extend the enjoyment of your fountain into the evening. Designed for partial or total submergence and is ETL listed and approved.

Ask about the entire line of
Kasco Fountains!!!



REAMS

www.reams.net

Grills



Angus BBQ

Model	Description
47628	Liquid Propane
47629	Natural Gas

- Standard Features:**
- 16 gauge - 304 stainless steel
 - 4 cast stainless burners 15,000 BTU's (60,000 BTU's)
 - Infrared burner 15,000 BTU's
 - Five bull sure-lite gas valves
 - Five heavy-duty push-to-turn knobs with ignition
 - Heavy-duty thermometer
 - Stainless steel cooking grates 600 sq. in. cooking area
 - Stainless steel warming rack 210 sq. in.
 - Stainless steel full size drip tray
 - Stainless steel rotisserie motor and chrome plated spit & rod
 - Hose & regulator included with lp models
 - N.G. regulator included with ng models

Brahma BBQ

Model	Description
57568	Liquid Propane
57569	Natural Gas

- Standard Features:**
- 16 gauge - 304 stainless steel
 - 5 cast stainless burners 15,000 BTU's (75,000 BTU's)
 - Infrared burner 15,000 BTU's
 - Six bull sure-lite gas valves
 - Six heavy-duty push-to-turn knobs with ignition
 - Heavy-duty thermometer
 - Stainless steel cooking grates 760 sq. in. cooking area
 - Stainless steel warming rack 266 sq. in.
 - Stainless steel full size drip tray
 - Stainless steel rotisserie motor and chrome plated spit & rod
 - Hose & regulator included with lp models
 - N.G. regulator included with ng models



BBQ Accessories

Model	Description
00002	Stainless steel ice chest
89975	Stainless steel single vertical door
33568	Stainless steel double door

Hose / Hose Fittings



Country Club Hose

Model	Description
SNCCC01100	1" x 100'
SNCCC0150	1" x 50'



Hose Fittings

Model	Description
530-008	3/4" FHT x 3/4" Fipt PVC
LL HF12	3/4" FHT x 3/4" FHT Brass

Ice Melt



Power Thaw

Model	Description
955-0050	-20° 50# Bag

Power Thaw is the premier commercial grade granular de-icer on the market today. It contains high levels of calcium and magnesium chloride to create a synergetic effect. Blue in color and melts to -20°

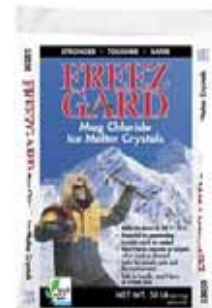

Freeze Gard Mag Chloride

Model	Description
CC50	-25° 50# Bag Pellets

100% Magnesium Chloride Hexahydrate. Safer on concrete and metal than other conventional ice melters when used as directed. Melts to -25°



Thaw Master

Model	Description
980-0050	-5° 50# Bag

Thaw Master is an exceptional, commercial strength granular ice melt that contains high powered additives for a fast effective melt. Green in color and melts to -5°

Insert Fittings



Tee	
Model	Description
1401005	1/2"
1401007	3/4
1401010	1
1401012	1 1/4
1401015	1 1/2
1401020	2"

Reducing Tee	
Model	Description
1401074	1/2 x 1/2 x 3/4"
1401094	3/4 x 1/2 x 1/2
1401099	3/4 x Swing
1401101	3/4 x 3/4 x 1/2
1401102	3/4 x 3/4 x 1
1401125	1 x 3/4 x 3/4
1401129	1 x Swing
1401130	1 x 1 x 1/2
1401131	1 x 1 x 3/4
1401132	1 x 1 x 1 1/4
1401157	1 1/4 x 1 x 3/4
1401158	1 1/4 x 1 x 1
1401166	1 1/4 x 1 1/4 x 1/2
1401167	1 1/4 x 1 1/4 x 3/4
1401168	1 1/4 x 1 1/4 x 1
1401201	1 1/2 x 1 1/4 x 3/4
1401202	1 1/2 x 1 1/4 x 1
1401203	1 1/2 x 1 1/4 x 1 1/4
1401210	1 1/2 x 1 1/2 x 3/4
1401211	1 1/2 x 1 1/2 x 1
1401212	1 1/2 x 1 1/2 x 1 1/4
1401241	2 x 1 1/2 x 1 1/2
1401248	2 x 2 x 3/4
1401249	2 x 2 x 1
1401250	2 x 2 x 1 1/4
1401251	2 x 2 x 1 1/2"

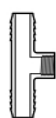
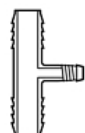

Combination Tee (Ins x Ins x Fipt)	
Model	Description
1402005	1/2"
1402007	3/4
1402010	1
1402012	1 1/4
1402015	1 1/2
1402101	3/4 x 3/4 x 1/2
1402124	1 x 3/4 x 1/2
1402125	1 x 3/4 x 3/4
1402130	1 x 1 x 1/2
1402131	1 x 1 x 3/4
1402156	1 1/4 x 1 x 1/2
1402157	1 1/4 x 1 x 3/4
1402166	1 1/4 x 1 1/4 x 1/2
1402167	1 1/4 x 1 1/4 x 3/4
1402168	1 1/4 x 1 1/4 x 1
1402199	1 1/2 x 1 1/4 x 1/2
1402201	1 1/2 x 1 1/4 x 3/4
1402202	1 1/2 x 1 1/4 x 1
1402209	1 1/2 x 1 1/2 x 1/2
1402210	1 1/2 x 1 1/2 x 3/4
1402211	1 1/2 x 1 1/2 x 1
1402212	1 1/2 x 1 1/2 x 1 1/4
1402247	2 x 2 x 1/2
1402248	2 x 2 x 3/4
1402249	2 x 2 x 1
1402251	2 x 2 x 1 1/2"

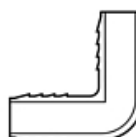

Combination Tee (Ins x Ins x Mipt)	
Model	Description
1403005	1/2"
1403007	3/4
1403010	1
1403012	1 1/4
1403015	1 1/2"

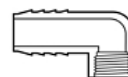

Side Outlet Tee	
Model	Description
1416130	1 x 1 x 1 x 1/2
1416131	1 x 1 x 1 x 3/4

Side Outlet 90° EII	
Model	Description
1414130	1 x 1 x 1/2
1414131	1 x 1 x 3/4

90° EII	
Model	Description
1406005	1/2"
1406007	3/4
1406010	1
1406012	1 1/4
1406015	1 1/2
1406020	2
1406101	3/4 x 1/2
1406131	1 x 3/4
1406168	1 1/4 x 1
1406212	1 1/2 x 1 1/4
1406251	2 x 1 1/2"

90° Comb EII (Ins x Fipt)	
Model	Description
1407005	1/2"
1407007	3/4
1407010	1
1407012	1 1/4
1407015	1 1/2
1407020	2
1407101	3/4 x 1/2
1407130	1 x 1/2
1407131	1 X 3/4
1407166	1 1/4 x 1/2
1407167	1 1/4 x 3/4
1407168	1 1/4 x 1
1407211	1 1/2 x 1
1407251	2 X 1"

Insert Fittings

90° Comb Ell (Ins x Mipt)

Model	Description
1413005	1/2"
1413007	3/4
1413010	1
1413012	1 1/4
1413015	1 1/2
1413020	2"

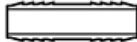
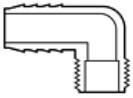

Coupler

Model	Description
1429005	1/2"
1429007	3/4
1429010	1
1429012	1 1/4
1429015	1 1/2
1429020	2
1429101	3/4 x 1/2
1429129	1"x Swing
1429130	1 x 1/2
1429131	1 x 3/4
1429167	1 1/4 x 3/4
1429168	1 1/4 x 1
1429210	1 1/2 x 3/4
1429211	1 1/2 x 1
1429212	1 1/2 x 1 1/4
1429249	2 x 1
1429250	2 x 1 1/4
1429251	2 x 1 1/2"

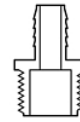
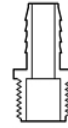

Cross

Model	Description
1420007	3/4"
1420010	1
1420012	1 1/4
1420015	1 1/2
1420020	2
1420131	1 x 3/4
1420168	1 1/4 x 1
1420211	1 1/2 x 1
1420212	1 1/2 x 1 1/4
1420251	2 x 1 1/2"



Male Adapter

Model	Description
1436005	1/2"
1436007	3/4
1436010	1
1436012	1 1/4
1436015	1 1/2
1436020	2
1436074	1/2 x 3/4
1436075	1/2 x 1
1436101	3/4 x 1/2
1436102	3/4 x 1
1436131	1 x 3/4
1436132	1 x 1 1/4
1436133	1 x 1 1/2
1436168	1 1/4 x 1
1436169	1 1/4 x 1 1/2
1436211	1 1/2 x 1
1436212	1 1/2 x 1 1/4
1436213	1 1/2 x 2
1436251	2 x 1 1/2"

Female Adapter

Model	Description
1435005	1/2"
1435007	3/4
1435010	1
1435012	1 1/4
1435015	1 1/2
1435020	2"

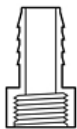

Insert Plug

Model	Description
1449005	1/2"
1449007	3/4
1449010	1
1449012	1 1/4
1449015	1 1/2
1449020	2"

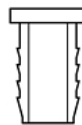

Insert Specialty Fittings



Blazing Fast Fittings CLAMPLESS!!!

Model	Description
EL 1007	End of Line 1" Poly x 1/2" Fipt Elbow
EL 1009	End of Line 1" Poly x Swing
BLZ 1401-010	1" Standard Tee
BLZ 1406-010	1" 90° Elbow
BLZ 1429-010	1" Standard Coupler
BLZ 1436-010	1" Male Adapter
BLZ PSC-010	1" Poly Stretch Coupler

Blazing Fast Fittings slip into 1" poly pipe quickly and do not require clamps!



Dawn Insert Fittings

Model	Description
DF 100SW	1" Barb x Swing
DI SC101	PVC 3/4 Spg/1/2HubxSwg
DI SC131	PVC 1 Spg/3/4 HubxSwng
DI ST007	PVC Tee 3/4" x Swing
DI ST010	PVC Tee 1" x Swing

Poly Stretch Coupler

Model	Description
RM PSC-10	1" Poly Stretch Coupler
RM PSC-12	1 1/4" Poly Stretch Coupler
RM PSC-15	1 1/2" Poly Stretch Coupler

Landscape Edging



Lawn Edging

Model	Description
AD-20	Ace of Diamond Edging-20'
BAS	Anchoring Stakes
ECF	8" Coupler
DD-20	Dandy Diamond Edging -20'
DBE-20	Diamond Back-No Stake Kit
SK-B	Stake Kit - 4 Stakes/ 1 Cpler
TEE-B	90° Tee Connector
60F	60° Vee Connector
90F	90° Corner

Paver Edging

Model	Description
DPE-8	8" Diamond Paver Edging
LECNAIL12	12" Paver Nail



Poly Board

Model	Description
PBAS4B	Poly Board 1x4 P Stake
PBAS6B	Poly Board 1x6 P Stake
PB4-20	Poly Board 1x4" - 20'
PB6-20	Poly Board 1x6" - 20'
PSK-B6	Poly Stake Kit-Bulk

Steel Edging

Model	Description
DE 1012SG	Steel 12" Stake-Green
DE 14-4-16	DuraEdge 14 Ga 4"x16'
DE 14-4-10G	14 Ga 4"x10' Green



www.reams.net

Landscape Fabric - Master Gardner



Weedender 3 oz - Gray

Model	Description
-------	-------------

328	4' x 50'
352	6' x 50'
404	3' x 50'
413	3' x 100'
423	3' x 300'
428	4' x 50'
447	4' x 300'
471	6' x 300'

Point bonded spun, non-woven, 100% polypropylene, blocks sunlight.



Steel Pin

Model	Description
-------	-------------

701	Steel Pin - 1 each
703	Steel Pins - Box of 75
706	6" Fabric Pins - Box of 500



Pro Weave Plus 4.5 oz - Black

Model	Description
-------	-------------

5404	3' x 50'
5413	3' x 100'
5422	3' x 250'
5446	4' x 250'
5448	5' x 250'
5470	6' x 250'
5477	8' x 250'
5482	12' x 250'

Woven polypropylene made of taped yarn. Polypropylene fiber needled into fabric to add coefficient of friction to prevent movement.



Landscape Materials



Mulch, Peat Moss, Compost, Erosion Mat, Silt Fence

Model	Description
-------	-------------

CYM-3	Cypress Mulch 3 cu. ft.
LM3	Landscapers Mix 3 cu. ft.
PBM3	Pine Bark Mulch 3 cu. ft.
TRM435	Erosion Matting - 900 Sq. Ft. Roll

REAMS

www.reams.net

Lighting - Holiday

Mini Incandescent

Model	Description
6-50-ML-G	25' Length Multi 6" Spac
6-50-CLR-G	25' Length Clear 6" Spac

Also available in colors red, blue, green, amber, purple, pink, frost, teal, yellow, candy cane, traditional



C7 LED Retro Fit Bulbs

Model	Description
LED-C75MULTI	Multi Color C7 Bulbs
LEDC7WW	Warm White C7 Bulbs

Also available in colors red, yellow, orange, blue, green, purple, pink



Cords

Model	Description
C7100G	100' C7 Cord Green
C7100W	100' C7 Cord White
C7100012G	1000' C7 Cord Green
C7100012W	1000' C7 Cord White
C9100G	100' C9 Cord Green
C9100W	100' C9 Cord White
C9100012G	1000' C9 Cord Green
C9100012W	1000' C9 Cord White
WIRE250G	Green Jumper 18 GA Wire 250' (also in brown & white)



Clips

Model	Description
39001	Shingle Tab
39007	Parapet Clip
39032	All in One Clip



Timer

Model	Description
TIME100	Manual Timer 15amp



Mini LED Standard Set

Model	Description
41693R-B	M-5 Warm White 4" Spacing, 70 Light Set
41617R-B	M-5 5 Multi 4" Spacing, 70 Light Set

Also available in colors red, yellow, orange, blue, green, purple, pink



C9 LED Retro Fit Bulbs

Model	Description
LEDC95MULTI	Multi Color C9 Bulbs
LEDC9WW	Warm White C9 Bulbs

Also available in colors red, yellow, orange, blue, green, purple, pink



Connectors

Model	Description
FEMALE600	Female Slide On Polarized
MALE200	Male Slide On - Quick
MALE600	Male Slide On Polarized
OUTLETBRN	In Line Outlet

Greenery

Model	Description
LEDGAR914	9'x14" PreLit Garland LED
GAR914UOR	9'x14" Unlit Garland
LEDWREATH24	24" PreLit Wreath LED
LEDWREATH36	36" PreLit Wreath LED
LEDWREATH48	48" PreLit Wreath LED
LEDWREATH60	60" PreLit Wreath LED
WREATH36UOR	36" UnLit Wreath
WREATH48UOR	48" UnLit Wreath
WREATH60UOR	60" UnLit Wreath
BOW131	Red Velvet 10"x22"
BOW134	Red Velvet 15"x28"



REAMS

www.reams.net

Lighting - Holiday



LED Linkables

Model	Description
LED-SB44W	Star Burst White
LED-AIC44W	Icicle White
LED-ASFL44WW	Snowflake Warm White
LED-AST44	Stocking

Linkables are great for rooflines on both residential and commercial properties. Available in Snowflakes, Icicles, Starbursts, Stockings, Peppermint Sticks, Candy Canes and other specialty designs.

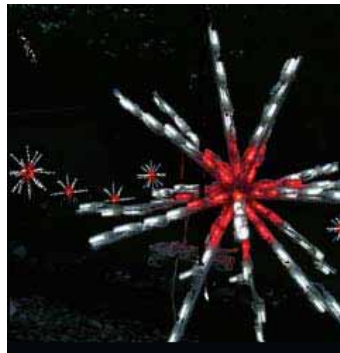

LED Starbursts

Model	Description
LED-SB12WW	12" Warm White
LED-SB12W	12" White
LED-SB24WW	24" Warm White
LED-SB24W	24" White
LED-SB24RW	24" Warm White

Starbursts are a great accent to hang in trees and in the landscape. Available in 12" and 24" in colors of White, Warm White, Red, Green, Blue, and combinations.

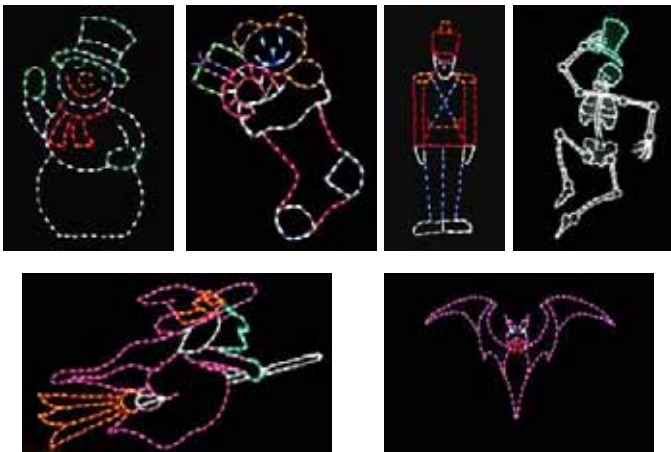

LED Holiday Displays

REAMS has displays available for any of the Holiday Seasons including St. Patricks Day, Easter, Valentines Day, Halloween, Thanksgiving, and especially Christmas.



There are many Holiday Decorating Items available from REAMS. Please contact your local REAMS representative for the complete product offerings.

REAMS

www.reams.net

Lighting - Landscape



FX Uplights

Model	Description
LR-20	LustroRame
MU-20	MacchiaUlitmo
RS-20	ReflectoreStellato
RL-20	RotondoLuna

Above Fixtures available in a variety of colors including Copper, Black Rinkle, Bronze Metallic, Desert Granite, Sedona Brown, Verde Speckle, Weathered Iron, White Wrinkle



FX Path Lights

Model	Description
BD-20	BellaDonna
CB-20	CapelliBiondi
DM-20	DelMare

Above Fixtures available in a variety of colors including Copper, Black Rinkle, Bronze Metallic, Desert Granite, Sedona Brown, Verde Speckle, Weathered Iron, White Wrinkle

FX Wall & Down Lights

Model	Description
CP-10	CandelaPasso Step Light
MM-10	MolluscoMuro Wall Light
CL-20	CopertinaLuce Downlight
LF1LED	LouwerFenetre UnderCap LED Light

Above Fixtures available in a variety of colors including Copper, Black Rinkle, Bronze Metallic, Desert Granite, Sedona Brown, Verde Speckle, Weathered Iron, White Wrinkle



FX Subterranean

Model	Description
LB-20	LagoBrillante Underwater MR- 16
SM-20	StellaMinuto Underwater MR-11
FC-20	FavolosaCaverna Well MR-11
RP-20	ResistentePilotare Well MR-16

Underwater Lights are made of Brass with 16' Cord Lengths.

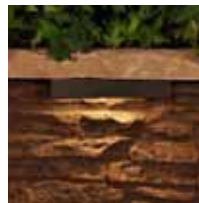

Lighting - Landscape



Illuminfx Fiber Optics Lighting

Model	Description
IL FOH-04	4 Light Set w/25' strand cable
IL FOH-08	8 Light Set w/25' strand cable
IL FOH-16	16 Light Set w/25' strand cable
IL H250E4	250 watt halogen Illumin
IL IFX7408	8 Light series 7
IL LED450	4 Light kit LED

Fixtures as small as a pen cap casting brilliant, bright light onto your waterfalls, streams, plants, landscape, and more. Put light in places never before thought possible. The first fiber optic lighting kit designed specifically for ponds and water features.



Integral Lighting



Model	Description
IL100.225	Integral Demo Kit
IL18.105	Hardscape Light 18" Copper
IL18.105.500	Hardscape Light 18" Copper LED
IL18.225	Hardscape Light 18" Bronze
IL18.225.500	Hardscape Light 18" Bronze LED
IL200-210	Upgrade Kit to LED
IL200-110	10 Watt Replacement Bulb
IL6.105	Hardscape Light Copper
IL6.105.500	Hardscape Light Copper LED
IL6.125	Hardscape Light Brass
IL6.125.500	Hardscape Light Brass LED
IL6.225	Hardscape Light Bronze
IL6.225.500	Hardscape Light Bronze LED

Integral Lighting is designed to change the way you install hardscape lighting forever. Simply insert between layers of your hardscape installation. No wasted block from chiseling. Self leveling when inserted. Also available in LED and in optional colors Stainless, Black, Clay, Putty, Brick Red, White, Bone, Sand, Mud, Terracotta, Pebble, Stone, and Slate

Lighting - Landscape

Kichler LED Path Lights

Model	Description
15810AZT	LED Dome Path Light AZT
15815AZT	LED Side Mount AZT
15817BN	LED Glass & Metal BN
15826AZT	LED Center Mount AZT
15843TZZ	LED Hammered Roof TZZ
15850CO	LED Copper Path CO
15870BBR	LED 6" Path Bronzed Bronze
15871TZZ	LED Cast Hammered TZZ



Kichler Spot / Well

Model	Description
15384AZT	Mini Accent-AZT
15395AZT	Adjustable Wide Flood-AZT
15190BK	MR-16 Well Light

Kichler LED Deck

Model	Description
15763TZZ	Hammered Roof TZZ - LED
15764AZT	Mini Deck Light AZT - LED
15765AZT	Mini Deck AZT - LED



Kichler LED - Specialty

Model	Description
15711SS	2 in 1 Underwater 4.5 Watt
15735AZT	LED 6" Wall Light W/O Bracket
15736AZT	LED 12" Wall Light W/O Bracket
15755AZT	LED 18" Wall Light W/O Bracket
15745AZT	LED 6" Wall Light W/Bracket
15746AZT	LED 12" Wall Light W/Bracket
15756AZT	LED 18" Wall Light W/Bracket
15861AZT	LED Wall Wash AZT

Kichler Path Lights

Model	Description
15310AZT	Dome Path Light AZT
15315AZT	Side Mount AZT
15318AZT	Galaxy AZT
15323AZT	Eclipse AZT
15324PZ	Leaf Patina Bronze
15350CO	Adjustable Copper
15381AZT	MR-16 Accent Light AZT
15396AZT	Mini Hooded Flood AZT
15443TZZ	Hammered Roof TZZ
15439CO	Fundamentals CO
15439OB	Fundamentals OB
15439TZZ	Fundamentals TZZ

Kichler LED - Spot

Model	Description
15731AZT	Spot 4.5 Watt - 10° Spread
15732AZT	Spot 4.5 Watt - 35° Spread
15733AZT	Spot 4.5Watt - 60° Spread
15741AZT	Spot 8.5 Watt - 10° Spread
15742AZT	Spot 8.5 Watt - 35° Spread
15743AZT	Spot 8.5 Watt - 60° Spread
15701AZT	Short Plastic Cowl for 4.5 Watt and 8.5 Watt Spots
15751AZT	Spot 12.4 Watt - 10° Spread
15752AZT	Spot 12.4 Watt - 35° Spread
15753AZT	Spot 12.4 Watt - 60° Spread
15702AZT	Short Plastic Cowl for 12.4 Watt Spot



Above also available in Black (BKT)



REAMS

www.reams.net

Lighting - Landscape

Radlax™ optics come in two forms – side-powered on larger fixtures, and center-powered on smaller ones. Both designs give Kichler® fixtures the greatest lumens per watt in the industry for comparable fixtures.



WARM WHITE
2700K

PURE WHITE
3000K

COOL WHITE
4200K

Kichler Radlax LED - Spot

Model	Description
16006AZT27	6.5w 10° - 2700K
16006AZT30	6.5w 10° - 3000K
16007AZT27	6.5w 35° - 2700K
16007AZT30	6.5w 35° - 3000K
16008AZT27	6.5w 60° - 2700K
16008AZT30	6.5w 60° - 3000K
16009AZT27	13w 10° - 2700K
16009AZT30	13w 10° - 3000K
16010AZT27	13w 35° - 2700K
16010AZT30	13w 35° - 3000K
16011AZT27	13w 60° - 2700K
16011AZT30	13w 60° - 3000K
16013AZT27	21w 35° - 2700K
16013AZT30	21w 35° - 3000K
16014AZT27	21w 60° - 2700K
16014AZT30	21w 60° - 3000K
16060AZT	Long Cowel for 6.5W & 13W

Kichler Radlax LED - Spot

Model	Description
16000AZT27	3w 10° - 2700K
16000AZT30	3w 10° - 3000K
16001AZT27	3w 35° - 2700K
16001AZT30	3w 35° - 3000K
16002AZT27	3w 60° - 2700K
16002AZT30	3w 60° - 3000K
16003AZT27	4w 10° - 2700K
16003AZT30	4w 10° - 3000K
16004AZT27	4w 35° - 2700K
16004AZT30	4w 35° - 3000K
16005AZT27	4w 60° - 2700K
16005AZT30	4w 60° - 3000K

Above also available in Black (BKT) and Beach (BE)

Kichler Radlax LED - In Ground

Model	Description
160031BBR27	4w 35° - 2700K Bronzed Brass
160031BBR30	4w 35° - 3000K Bronzed Brass

REAMS

www.reams.net

Lighting - Landscape



Vista Spot

Model	Description
GR2216Z	Spot-Bronze MR-16
GR2116CS	Spot-Copper MR-16



Vista Path Light

Model	Description
PR2160CS	Path-Copper
PR2165CS	Mini Path-Copper
PR2127SS	Mini Path-Stainless



All Vista Path Lights available in LED in a couple of different light outputs

Vista LED Spot

Model	Description
3003-M	LED Spot



Vista Specialty

Model	Description
UW4217B	Composite Underwater
UW5217B	Underwater Adjustable
4260-Z	Under Cap Light



Vista Well

Model	Description
GW5260B	Well-Black MR-16 w/ Grate
GW5261B	Well-Black MR-16 w/ Shield
GW5262B	Well-Black MR-16 Flat Glass
GW5270B	Well Composite MR-16 w/ Grate
GW5271B	Well Composite MR-16 w/ Shield
GW5272B	Well Composite MR-16 w/ Glass



All of the previous Landscape Lighting Fixtures by Integral, Kichler, and Vista are standard REAMS stocking items. Each fixture has many different options, finishes, and accessories available specific for each fixture. For an entire fixture line catalog, please contact your local REAMS representative.

Lighting - Transformers

FX Transformers

Model Description

LX150 150 Watt

LX300 300 Watt

Industry's first fully digital programmable Transformer

Kichler

Model Description

15E60BK 60 Watt Economy

15PL100AZT 100 Watt - AZT

15PL200AZT 200 Watt - AZT

15PL300AZT 300 Watt - AZT

15PL600AZT 600 Watt - AZT

15PL900AZT 900 Watt - AZT

15PR200SS 200 Watt - SS

15PR300SS 300 Watt - SS

15PR600SS 600 Watt - SS

15PR900SS 900 Watt - SS

PL Series, and PR Series come with 12V, 13V, 14V, & 15V taps, pluggable timer and photocell outlets. PR Series features a commercial grade toroid core and coil submersible rating, plus a lifetime warranty. PL series has a 10 year warranty and they are not approved for Underwater fixtures.

Kichler Trans Acces.

Model Description

15556 Timer Digital

15557 Timer Analog

15565BK Photocell

ControlScape

Model Description

CSART Astronomical Timer

Turns Transformer on or off based on Sunrise and Sunset. Adjusts for Daylight savings time. Automatically.

Vista

Model Description

ES150 150w Ideal for LED

CTS300 CTS 300w

CTS300T CTS 300w w/timer

CTS600 CTS 600w

CTS600T CTS 600w w/timer

CTS900 CTS 900w

CTS900T CTS 900w w/timer

MT300 MT 300w

MT300T MT 300w w/timer

MT600 MT 600w

MT600T MT 600w w/timer

MT900 MT 900w

MT900T MT 900w w/timer

MT1200 MT 1200w

MT1200T MT 1200w w/timer

CTS Transformers are standard 12V. MT Transformers are Multi Tapped with 12V, 13V, and 14V outputs.

Vista Trans Acces.

Model Description

DTC170 Digital 7 day w/Bat

DTC200 Astronomical Timer

DTC210 Astronomical Timer - Dual Output

FPC150 Photo Cell

FPC160 Photo Cell-HW

FPC170 Photo Cell w/knuckle

TC112 24hr Plug in Timer



Lighting - Incandescent Bulbs

MR-11

Model	Description
-------	-------------

FTA10	10 watt 30°
FTB20	20 watt 10°
FTC20	20 watt 18°
FTD20	20 watt 30°
FTF35	35 watt 30°
FTM12	12 watt 19°
FTW12	12 watt 25°



MR-16 Covered Lens

Model	Description
-------	-------------

MFL10C	10watt 24
BAB20C	20watt 42°
BAB60C	20watt 60°
ESX20C	20watt 13°
EXZ20C	20watt 7°
FMW35C	35watt 40°
FRA35C	35watt 20°
FRB35C	35watt 12°
EXN50C	50watt 40°
EXT50C	50watt 14°
EXZ50C	50watt 27°
FNV50C	50watt 55°



Bi Pin

Model	Description
-------	-------------

10T3	T3 10 watt
20T3	T3 20 watt
35T3	T3 35 watt
20T4	T4 20 watt
35T4	T4 35 watt
50T4	T4 50 watt



Wedge

Model	Description
-------	-------------

3155	Wedge 18.5 watt
3156	Wedge 24.4 watt
904	T5 7.5 watt
906	T5 8 watt
912	T5 11.8 watt
918	T5 6.5 watt
921	T5 16.5 watt
923	T5 18 watt



PAR 36

Model	Description
-------	-------------

25NSP	25 watt Narrow Spot
25WFL	25 watt Wide Flood
36NSP	36 watt Narrow Spot
36WFL	36 watt Wide Flood
4414	14.9 watt
4446	25 watt
50NSP	50 watt Narrow Spot
50WFL	50 watt Wide Flood
7558	14.4 watt Halogen
7606	50 watt Halogen



Bayonet

Model	Description
-------	-------------

1141	15.6 w
1142	18 w DBC
1156	21.2 w
73	Border Lite Bulb
93	12.3 w
94	13 w DBC



REAMS

www.reams.net

Lighting - LED Bulbs



LED MR-16 Lamp Brilliance

Model	Description
BL-SD17A-WW-15	3 watt LED MR-16, 15 Degree 3000K WARM WHITE
BL-SD17A-WW-30	3 watt LED MR-16, 30 Degree 3000K WARM WHITE
BL-SD17A-WW-60	3 watt LED MR-16, 60 Degree 3000K WARM WHITE
BL-SD17A-RED-60	3 watt LED MR-16, 60 Degree RED
BL-SD17A-RED-30	3 watt LED MR-16, 30 Degree RED
BL-SD17A-GREEN-60	3 watt LED MR-16, 60 Degree GREEN
BL-SD17A-GREEN-30	3 watt LED MR-16, 30 Degree GREEN
MR16-5-WW-30	5 watt LED MR-16, 30 Degree WARM WHITE
MR16-5-WW-60	5 watt LED MR-16, 60 Degree WARM WHITE

40,000 Hour Lamp Life



LED Bayonet Lamp Brilliance

Model	Description
30014	1156 LED - SC Bayonet 1.5 watt 2700K

40,000 Hour Lamp Life



LED Bi-Pin G4 Lamp Brilliance

Model	Description
BLG4WW	Bi-Pin Dynasty G4 1.5 Watt

40,000 Hour Lamp Life

Nozzles - Spray

Hunter Nozzles

Model	Description
HT2H	2' Half
HT2Q	2' Quarter
HT4H	4' Half
HT4Q	4' Quarter
HT6H	6' Half
HT6Q	6' Quarter
HT8A	8' Adjustable
HT8F	8' Full
HT8H	8' Half
HT8Q	8' Quarter
HT10A	10' Adjustable
HT10F	10' Full
HT10H	10' Half
HT10Q	10' Quarter
HT12A	12' Adjustable
HT12F	12' Full
HT12H	12' Half
HT12Q	12' Quarter
HT15A	15' Adjustable
HT15F	15' Full
HT15H	15' Half
HT15Q	15' Quarter
HT17A	17' Adjustable
HTLCS515	Left Corner Strip
HTRCS515	Right Corner Strip
HTSS-530	Side Strip



Rain Bird Nozzles

Model	Description
RB4VAN	4' Variable Arc Noz
RB5F	5' Full
RB5H	5' Half
RB5Q	5' Quarter
RB6VAN	6' Variable Arc Noz
RB8F	8' Full
RB8H	8' Half
RB8Q	8' Quarter
RB8VAN	8' Variable Arc Noz
RB10F	10' Full
RB10H	10' Half
RB10Q	10' Quarter
RB10VAN	10' Variable Arc
RB12F	12' Full
RB12H	12' Half
RB12Q	12' Quarter
RB12T	12' One-Third
RB12TQ	12' Three-Quarters
RB12TT	12' Two-Thirds
RB12VAN	12' Variable Arc
RB15F	15' Full
RB15H	15' Half
RB15Q	15' Quarter
RB15SQ	15' Square
RB15T	15' One-Third
RB15TQ	15' Three-Quarters
RB15TT	15' Two-Thirds
RB15CST	15' Center Strip
RB15EST	15' End Strip
RB15SST	15' Side Strip
RB15VAN	15' Var. Arc Noz
RBLCS	Left Corner Strip
RBRCS	Right Corner Strip

U-Series/MPR Nozzles



Specialty



15 feet



12 feet



10 feet



8 feet



5 feet

U-Series Nozzle

Model	Model
RBUI0F	U12TQ
RBUI0H	U15F
RBUI0Q	U15H
RBUI2F	U15Q
RBUI2H	U15T
RBUI2Q	U15TT
RBUI2T	U15TQ
RBUI2TT	U12TT

Patented "second-orifice" design for effective close-in watering and more uniform water distribution.

NEW HE-VAN Nozzles

Model	Description
RB12HEVAN	12' Variable Arc
RB15HEVAN	15' Variable Arc

The HE-VAN (High-Efficiency) provides a level of distribution uniformity (DU) that few nozzles can match, along with full adjustability from 0° to 360°. Patent pending Flow Control Technology delivers superior close-in watering and uniform coverage across the entire spray pattern. In addition to water savings, HE-VANs dramatically reduce zone run times.



Polyethylene Pipe



2406 80# Poly

Model	Description
5110007	3/4" Black
4000007	3/4" Pro Turf Green
4000010	1" Pro Turf Green
5130010	1" Black
5110010	1" Green Stripe
5110012	1 1/4" Black
4000012	1 1/4" Pro Turf Green
5110015	1 1/2" Black
5110020	2" Black

3408 80# Poly

Model	Description
5000010	1" Pro Turf Green
5150010	1" Black
5140010	1" Green Stripe
5150012	1 1/4" Black
5150015	1 1/2" Black
5150020	2" Black
8000010	1" Pro Turf Blue

3408 100# Poly

Model	Description
5160007	3/4" Black
5160010	1" Black
6000010	1" Pro Turf Green
5160012	1 1/4" Black
5160015	1 1/2" Black
5160020	2" Black



2406 100# Poly

Model	Description
5110105	1/2" Black
5110110	1" Black
5110115	1 1/2" Black

Pure Core 80# Poly

Model	Description
7000007	3/4" Pure Core
7000010	1" Pure Core
7000012	1 1/4" Pure Core

3408 160# Poly

Model	Description
5170010	1" Black
5170015	1 1/2" Black



Pure Core 200# Poly

Model	Description
2000015	1 1/2" Pure Core

Poly Nipples



Poly Nipple

Model	Description
M434-0053	1/2" x 3" Riser Ext.
M434-0074	3/4" x 4" Riser Ext.
SP N4	1/2" x 3/4" x Close



Cut-Off Nipple

Model	Description
FCO0500	1/2" x 6" Black
492060	1/2" x 3/4" x 6" BL
M481005	1/2" x 6" Brown
M481007	3/4" x 6" Brown
M481101	1/2" x 3/4" x 6" BR

Porous Pave



Porous Pave

Model	Description
B5H	Porous Hard Binder - 5 Gallon Pail
B5S	Porous Soft Binder - 5 Gallon Pail
R50BD	50# Bag - Washed Kiln Dried Rock
R50BL	Porous 50# Bag Rubber Chips - Black
R50BN	Porous 50# Bag Rubber Chips - Brown
R50CY	Porous 50# Bag Rubber Chips - Cypress
R50GN	Porous 50# Bag Rubber Chips - Green
R50GY	Porous 50# Bag Rubber Chips - Grey
R50TN	Porous 50# Bag Rubber Chips - Tan
R50RW	Porous 50# Bag Rubber Chips - Redwood

Porous Pave is a revolutionary paving product made from recycled tires, aggregate and urethane binder.

Some of the benefits of this product are:

- Highly permeable – allows large amounts of rainwater to pass through into the ground while providing a hard surface
- Flexible – 50% rubber content allows Porous Pave to remain flexible which eliminates cracking, especially in freezing climate freeze/thaw
- Durable – Porous Pave can be used in parking lots, driveways and other high use applications. Also resistant to snow plow damage!
- Super strong – installed at 2" thick Porous Pave can handle low speed vehicle traffic, installed at 1-1/2" thick for pathways, patios, trails and other pedestrian applications. Use at 1" thick to over-pour existing concrete/asphalt areas.

REAMS

www.reams.net

Portable Irrigation System



Yard Camel

Model	Description
YC-CONTROL	4 Station Bat. Controller
YC-100	4 Station Bat. Control w/8 sprinklers on spikes
YC-200	4 Station Bat. Control w/4 sprinklers on spyderys

Portable, multiple zone, timed watering system. Complete with controller, valves and zinc impact heads on zinc spikes.

PVC Nipples

PVC Nipple 1/2"

Model	Desc
882005	1/2" x Close
882015	1/2" x 1 1/2"
882020	1/2" x 2"
882030	1/2" x 3"
882040	1/2" x 4"
882050	1/2" x 5"
882060	1/2" x 6"
882080	1/2" x 8"
882100	1/2" x 10"
882120	1/2" x 12"
882140	1/2" x 14"
882180	1/2" x 18"
882240	1/2" x 24"
882360	1/2" x 36"
882480	1/2" x 48"

PVC Nipple 3/4"

Model	Desc
883005	3/4" x Close
883020	3/4" x 2"
883025	3/4" x 2 1/2"
883030	3/4" x 3"
883040	3/4" x 4"
883050	3/4" x 5"
883060	3/4" x 6"
883080	3/4" x 8"
883100	3/4" x 10"
883120	3/4" x 12"
883180	3/4" x 18"
883240	3/4" x 24"
883360	3/4" x 36"

PVC Nipple 1"

Model	Desc
884005	1" x Close
884020	1" x 2"
884025	1" x 2 1/2"
884030	1" x 3"
884040	1" x 4"
884050	1" x 5"
884060	1" x 6"
884080	1" x 8"
884100	1" x 10"
884110	1" x 11"
884120	1" x 12"
884180	1" x 18"
884240	1" x 24"

2 1/2" 3" 4"

Model	Desc
888005	2 1/2" x Close
889005	3" x Close
889030	3" x 3"
889120	3" x 12"
890005	4" x Close

PVC Toe Nipple (Thread on One End Only)

Model	Desc
1884030	1" x 3"
1886030	1 1/2" x 3"
1886040	1 1/2" x 4"
1887030	2" x 3"
1887040	2" x 4"
1887060	2" x 6"
1887080	2" x 8"
1888080	2 1/2" x 8"

PVC Nipple 1 1/4"

Model	Desc
885005	1 1/4" x Close
885020	1 1/4" x 2"
885040	1 1/4" x 4"
885060	1 1/4" x 6"
885120	1 1/4" x 12"



PVC Nipple 1 1/2"

Model	Desc
886005	1 1/2" x Close
886020	1 1/2" x 2"
886030	1 1/2" x 3"
886040	1 1/2" x 4"
886050	1 1/2" x 5"
886060	1 1/2" x 6"
886080	1 1/2" x 8"
886100	1 1/2" x 10"
886120	1 1/2" x 12"

PVC Nipple 2"

Model	Desc
887005	2" x Close
887025	2" x 2 1/2"
887030	2" x 3"
887040	2" x 4"
887060	2" x 6"
887080	2" x 8"
887100	2" x 10"
887120	2" x 12"

PVC Nipple Plain (No Threads on Either End)

Model	Desc
884020P	1" x 2"
884030P	1" x 3"
884040P	1" x 4"
884060P	1" x 6"
887040P	2" x 4"
887060P	2" x 6"

REAMS

www.reams.net

PVC Pipe



PVC Class 160# SDR26

Model	Description
5440012	1 1/4"
5440015	1 1/2"
5440020	2"
5440025	2 1/2"
5440030	3"
5440040	4"
5440060	6"

PVC Class 200# SDR21

Model	Description
5550005	1/2"
5550007	3/4"
5550010	1"
5550012	1 1/4"
5550015	1 1/2"
5550020	2"
5550025	2 1/2"
5550030	3"
5550040	4"
5550060	6"



Class 160 Gasket

Model	Description
GSK0020	2"
GSK0025	2 1/2"
GSK0030	3"
GSK0040	4"
GSK0060	6"

Class 200 Gasket

Model	Description
GSK1020	2"
GSK1025	2 1/2"
GSK1030	3"
GSK1040	4"
GSK1060	6"
GSK1080	8"
GSK1010	10"

PVC Schedule 40

Model	Description
5400005	1/2"
5400007	3/4"
5400010	1"
5400012	1 1/4"
5400015	1 1/2"
5400020	2"
5400025	2 1/2"
5400030	3"
5400040	4"
5400060	6"
5400080	8"



Gasket Lube

Model	Description
3060010	Quart
3061000	Gallon



PVC Fittings SCH 40



Tee Socket	
Model	Description
401005	1/2"
401007	3/4"
401010	1"
401012	1 1/4"
401015	1 1/2"
401020	2"
401025	2 1/2"
401030	3"
401040	4"
401060	6"

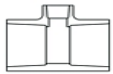

Reducing Tee Soc	
Model	Description
401074	1/2 x 1/2 x 3/4"
401101	3/4 x 3/4 x 1/2"
401102	3/4 x 3/4 x 1"
401124	1 x 3/4 x 1/2"
401125	1 x 3/4 x 3/4"
401130	1 x 1 x 1/2"
401131	1 x 1 x 3/4"
401132	1 x 1 x 1 1/4"
401133	1 x 1 x 1 1/2"
401157	1 1/4 x 1 x 3/4"
401158	1 1/4 x 1 x 1"
401166	1 1/4 x 1 1/4 x 1/2"
401167	1 1/4 x 1 1/4 x 3/4"

Red Tee Cont'd	
Model	Description
401168	1 1/4 x 1 1/4 x 1"
401169	1 1/4 x 1 1/4 x 1 1/2"
401170	1 1/4 x 1 1/4 x 2"
401202	1 1/2 x 1 1/4 x 1"
401209	1 1/2 x 1 1/2 x 1/2"
401210	1 1/2 x 1 1/2 x 3/4"
401211	1 1/2 x 1 1/2 x 1"
401212	1 1/2 x 1 1/2 x 1 1/4"
401213	1 1/2 x 1 1/2 x 2"
401214	1 1/2 x 1 1/2 x 2 1/2"
401238	2 x 1 1/2 x 3/4"
401239	2 x 1 1/2 x 1"
401241	2 x 1 1/2 x 1 1/2"
401247	2 x 2 x 1/2"
401248	2 x 2 x 3/4"
401249	2 x 2 x 1"
401250	2 x 2 x 1 1/4"
401251	2 x 2 x 1 1/2"
401288	2 1/2 x 2 1/2 x 3/4"
401289	2 1/2 x 2 1/2 x 1"
401290	2 1/2 x 2 1/2 x 1 1/4"
401291	2 1/2 x 2 1/2 x 1 1/2"
401292	2 1/2 x 2 1/2 x 2"
401335	3 x 3 x 1"
401336	3 x 3 x 1 1/4"
401337	3 x 3 x 1 1/2"
401338	3 x 3 x 2"
401342	3 x 3 x 4"
401417	4 x 4 x 1"
401419	4 x 4 x 1 1/2"
401420	4 x 4 x 2"
401422	4 x 4 x 3"
401528	6 x 2"



Tee Soc x Fipt	
Model	Description
402005	1/2"
402007	3/4"
402010	1"
402012	1 1/4"
402015	1 1/2"
402020	2"
402025	2 1/2"
402030	3"

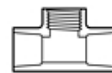

Reducing Tee Soc x Fipt	
Model	Description
402101	3/4 x 3/4 x 1/2"
402124	1 x 3/4 x 1/2"
402130	1 x 1 x 1/2"
402131	1 x 1 x 3/4"
402156	1 1/4 x 1 x 1/2"
402157	1 1/4 x 1 x 3/4"
402158	1 1/4 x 1 x 1"
402166	1 1/4 x 1 1/4 x 1/2"
402167	1 1/4 x 1 1/4 x 3/4"
402168	1 1/4 x 1 1/4 x 1"
402201	1 1/2 x 1 1/4 x 3/4"
402202	1 1/2 x 1 1/4 x 1"
402209	1 1/2 x 1 1/2 x 1/2"
402210	1 1/2 x 1 1/2 x 3/4"
402211	1 1/2 x 1 1/2 x 1"
402212	1 1/2 x 1 1/2 x 1 1/4"
402238	2 x 1 1/2 x 3/4"

Red Tee Cont'd	
Model	Description
402239	2 x 1 1/2 x 1"
402247	2 x 2 x 1/2"
402248	2 x 2 x 3/4"
402249	2 x 2 x 1"
402250	2 x 2 x 1 1/4"
402251	2 x 2 x 1 1/2"
402287	2 1/2 x 2 1/2 x 1/2"
402288	2 1/2 x 2 1/2 x 3/4"
402289	2 1/2 x 2 1/2 x 1"
402290	2 1/2 x 2 1/2 x 1 1/4"
402291	2 1/2 x 2 1/2 x 1 1/2"
402334	3 x 3 x 3/4"
402335	3 x 3 x 1"
402336	3 x 3 x 1 1/4"
402337	3 x 3 x 1 1/2"
402338	3 x 3 x 2"
402417	4 x 4 x 1"
402419	4 x 4 x 1 1/2"
402420	4 x 4 x 2"
402422	4 x 4 x 3"
402530	6 x 6 x 3"

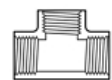

Tee Fipt x Fipt	
Model	Description
405005	1/2"
405007	3/4"
405010	1"
405012	1 1/4"
405015	1 1/2"
405020	2"

PVC Fittings SCH 40



90° Ell Soc

Model	Description
406005	1/2"
406007	3/4"
406010	1"
406012	1 1/4"
406015	1 1/2"
406020	2"
406025	2 1/2"
406030	3"
406040	4"
406060	6"



Reducing Ell Soc

Model	Description
406101	3/4 x 1/2"
406130	1 x 1/2"
406131	1 x 3/4"
406168	1 1/4 x 1"
406211	1 1/2 x 1"
406251	2 x 1 1/2"

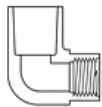

Reducing Ell Soc x Fipt

Model	Description
407005	1/2"
407007	3/4"
407010	1"
407012	1 1/4"
407015	1 1/2"
407020	2"
407025	2 1/2"
407030	3"



Reducing Ell S x Fipt

Model	Description
407101	3/4 x 1/2"
407130	1 x 1/2"
407131	1 x 3/4"
407168	1 1/4 x 1"
407211	1 1/2 x 1"
407251	2 x 1 1/2"



90° Ell Fipt x Fipt

Model	Description
408005	1/2"
408007	3/4"
408010	1"
408012	1 1/4"
408015	1 1/2"
408020	2"



90° Street Ell Spig x Soc

Model	Description
409007	3/4"
409010	1"
409012	1 1/4"
409015	1 1/2"
409020	2"



90° St Ell Mipt x Soc

Model	Description
410005	1/2"
410007	3/4"
410010	1"
410012	1 1/4"
410015	1 1/2"
410020	2"



90° St Ell Mipt x Fipt

Model	Description
412005	1/2"
412007	3/4"
412010	1"
412012	1 1/4"
412015	1 1/2"
412020	2"



Side Outlet Ell Soc x Fipt

Model	Description
414101	3/4 x 3/4 x 1/2" Side Outlet
414130	1 x 1 x 1/2" Side Outlet



22 1/2° Ell Soc

Model	Description
416020	2"
416030	3"
416040	4"



45° Ell Soc

Model	Description
417005	1/2"
417007	3/4"
417010	1"
417012	1 1/4"
417015	1 1/2"
417020	2"
417025	2 1/2"
417030	3"
417040	4"
417060	6"



Cross Soc

Model	Description
420005	1/2"
420007	3/4"
420010	1"
420012	1 1/4"
420015	1 1/2"
420020	2"
420025	2 1/2"
420030	3"
420040	4"

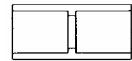

Coupler Soc

Model	Description
429005	1/2"
429007	3/4"
429010	1"
429012	1 1/4"
429015	1 1/2"
429020	2"
429025	2 1/2"
429030	3"
429040	4"
429050	5"
429060	6"

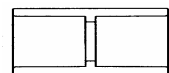

Deep Socket Cplr

Model	Description
479020	2"
479030	3"
479040	4"

PVC Fittings SCH 40



Reducing Coupler

Model	Description
429101	3/4 x 1/2"
429131	1 x 3/4"
429168	1 1/4 x 1"
429212	1 1/2 x 1 1/4"
429251	2 x 1 1/2"
429338	3 x 2"



Threaded Coupler

Model	Description
430005	1/2"
430007	3/4"
430010	1"
430015	1 1/2"
43005G	1/2" Gray
43007G	3/4" Gray
430015S	1 1/2" w/Steel Collars
430101G	3/4 x 1/2" Reducing Coupler
430131G	1 x 3/4" Reducing Coupler



Riser Extension

Model	Description
4340005	1/2"
4340007	3/4"
4340010	1"

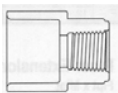

Reducing Female Adapter

Model	Description
4350101	3/4 x 1/2"
4350131	1 x 3/4"



Female Adapter

Model	Description
435005	1/2"
435007	3/4"
435010	1"
435012	1 1/4"
435015	1 1/2"
435020	2"
435025	2 1/2"
435030	3"
435040	4"



Male Adapter

Model	Description
436005	1/2"
436007	3/4"
436010	1"
436012	1 1/4"
436015	1 1/2"
436020	2"
436025	2 1/2"
436030	3"
436040	4"
436060	6"

Red Male Adapter Mipt x Soc

Model	Description
436074	1/2 x 3/4"
436101	3/4 x 1/2"
436102	3/4 x 1"
436131	1 x 3/4"
436132	1 x 1 1/4"
436168	1 1/4 x 1"
436213	1 1/2 x 2"
436251	2 x 1 1/2"
436252	2 x 2 1/2"
436294	2 1/2 x 3"
436342	3 x 4"



Reducer Bushing Spig x Soc

Model	Description
437101	3/4 x 1/2"
437130	1 x 1/2"
437131	1 x 3/4"
437166	1 1/4 x 1/2"
437167	1 1/4 x 3/4"
437168	1 1/4 x 1"
437209	1 1/2 x 1/2"
437210	1 1/2 x 3/4"
437211	1 1/2 x 1"
437212	1 1/2 x 1 1/4"
437247	2 x 1/2"
437248	2 x 3/4"
437249	2 x 1"
437250	2 x 1 1/4"
437251	2 x 1 1/2"
437287	2 1/2 x 1/2"
437289	2 1/2 x 1"
437290	2 1/2 x 1 1/4"
437291	2 1/2 x 1 1/2"
437292	2 1/2 x 2"
437334	3 x 3/4"
437335	3 x 1"
437336	3 x 1 1/4"
437337	3 x 1 1/2"
437338	3 x 2"
437339	3 x 2 1/2"
437420	4 x 2"
437421	4 x 2 1/2"
437422	4 x 3"
437486	5 x 2"
437488	5 x 3"
437490	5 x 4"
437528	6 x 2"
437530	6 x 3"
437532	6 x 4"



Reducer Bushing Spig x Fipt

Model	Description
438071	1/2" x 1/8"
438101	3/4 x 1/2"
438130	1 x 1/2"
438131	1 x 3/4"
438166	1 1/4 x 1/2"
438167	1 1/4" x 3/4"
438168	1 1/4 x 1"
438209	1 1/2 x 1/2"
438210	1 1/2 x 3/4"
438211	1 1/2 x 1"
438212	1 1/2 x 1 1/4"
438247	2 x 1/2"
438248	2 x 3/4"
438249	2 x 1"
438250	2 x 1 1/4"
438251	2 x 1 1/2"
438288	2 1/2 x 3/4"
438289	2 1/2 x 1"
438290	2 1/2 x 1 1/4"
438291	2 1/2 x 1 1/2"
438292	2 1/2 x 2"
438334	3 x 3/4"
438335	3 x 1"
438336	3 x 1 1/4"
438337	3 x 1 1/2"
438338	3 x 2"
438339	3 x 2 1/2"
438420	4 x 2"
438421	4 x 2 1/2"
438422	4 x 3"
438530	6 x 3"
438532	6 x 4"

PVC Fittings SCH 40

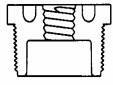

Reducing Bushing Mipt x Fipt	
Model	Description
439101	3/4 x 1/2"
439130	1 x 1/2"
439131	1 x 3/4"
439166	1 1/4 x 1/2"
439167	1 1/4 x 3/4"
439168	1 1/4 x 1"
439209	1 1/2 x 1/2"
439210	1 1/2 x 3/4"
439211	1 1/2 x 1"
439212	1 1/2 x 1 1/4"
439249	2 x 1"
439250	2 x 1 1/4"
439251	2 x 1 1/2"
439292	2 1/2 x 2"
439338	3 x 2"
439339	3 x 2 1/2"

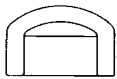

Cap Soc	
Model	Description
447005	1/2"
447007	3/4"
447010	1"
447012	1 1/4"
447015	1 1/2"
447020	2"
447025	2 1/2"
447030	3"
447040	4"
447050	5"
447060	6"
447080	8"



Cap Fipt	
Model	Description
448005	1/2"
448007	3/4"
448010	1"
448012	1 1/4"
448015	1 1/2"
448020	2"
448025	2 1/2"
448030	3"
448040	4"
448060	6"



Plug Spig	
Model	Description
449010	1"
449015	1 1/2"



Plug Mipt	
Model	Description
450005	1/2"
450007	3/4"
450010	1"
450012	1 1/4"
450015	1 1/2"
450020	2"
450030	3"
450040	4"



Insert x Spig	
Model	Description
460010	1"
460012	1 1/4"
460015	1 1/2"
460020	2"

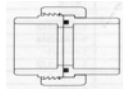

Union Soc x Soc	
Model	Description
457005	1/2"
457007	3/4"
457010	1"
457012	1 1/4"
457015	1 1/2"
457020	2"
457030	3"
457040	4"

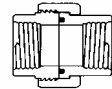

Union Fipt x Fipt	
Model	Description
458005	1/2"
458007	3/4"
458010	1"
458012	1 1/4"
458015	1 1/2"
458020	2"



Insert x Soc	
Model	Description
474005	1/2"
474007	3/4"
474010	1"
474012	1 1/4"
474015	1 1/2"
474020	2"

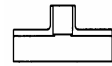

Snap Saddle Slip	
Model	Description
463010	1 x 1"
463012	1 1/4 x 1 1/4"
463015	1 1/2 x 1 1/2"
463020	2 x 2"



Snap Saddle Fipt	
Model	Description
464005	1/2 x 1/2"
464007	3/4 x 3/4"
464101	3/4 x 1/2"
464130	1 x 1/2"
464210	1 1/2 x 3/4"

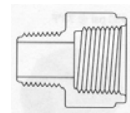

Adapter Mipt x Fipt	
Model	Description
446074	1/2 x 3/4"

PVC Gasket Fittings

Repair Coupling (No Stop)

Model	Description
1090015	1 1/2"
1090020	2"
1090025	2 1/2"
1090030	3"
1090040	4"
1090060	6"
1090080	8"

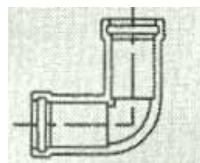
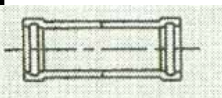

90° Ell

Model	Description
118020	2"
118025	2 1/2"
118030	3"
118040	4"

45° Ell

Model	Description
122025	2 1/2"
122030	3"
122040	4"
122060	6"

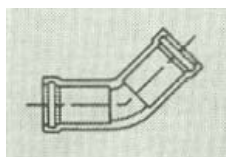

Tee

Model	Description
112220	2"
112255	2 1/2"
112330	3"
112440	4"
112660	6"

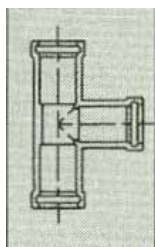

Tapped Tee

Model	Description
151204	2 x 1"
151206	2 x 1 1/2"
151254	2 1/2 x 1"
151256	2 1/2 x 1 1/2"
151304	3 x 1"
151306	3 x 1 1/2"
151308	3 x 2"
151404	4 x 1"
151406	4 x 1 1/2"
151408	4 x 2"
151604	6 x 1"
151606	6 x 1 1/2"
151608	6 x 2"

Spigot Adapter

Model	Description
130020	2"
130025	2 1/2"
130030	3"
130040	4"
130060	6"

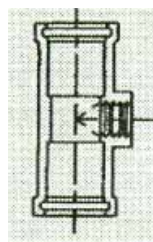
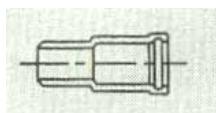

Ask your Local REAMS Representative about the entire line of Gasket PVC Fittings!!!

PVC Manifold Fittings



Manifold Cross & Tee

Model	Description
PF 616111	1" Manifold Cross
PF 616116	1" Manifold Tee

REAMS

www.reams.net

Pump Start Relays



Hunter

Model	Description
PSR22	Double Pole 2 HP
PSR52	Double Pole 5HP
PSR53	Triple Pole 5HP



Munro

Model	Description
MPSR24V	2 HP 120V 1Ø

Rain Bird

Model	Description
PSR24WG1	Universal Relay 110V
PSR24WG2	Universal Relay 220V
RBLC24WG1	PSRP Relay 110V
RBLC24WG2	PSRP Relay 220V

The Rain Bird PSRP Pump Start Relay monitors an irrigation system to protect the pump from damage due to low pressure.



Sensors - Irrigation



Hunter Rain Sensor

Model	Description
WRCLI	Wireless Rain Sensor
MINICLIK	Mini-Clik®
RAINCLIK	Wired Rain Sensor



Wind-Clik™ Sensor

Model	Description
HTWINDCLIK	Wind Click™

Control irrigation system operation during high wind conditions.



Rain Bird Rain Sensor

Model	Description
RSDBEX	Rain Sensor
WR2RC	Wireless Rain Sensor



Irritrol

Model	Description
RS1000	Wireless Rain Sensor
RFS1000	Wireless Rain/Freeze

Suspends irrigation during rainfall, and the wireless rain/freeze sensors reduce the damage to plants and danger to walkways caused by ice by interrupting irrigation at a certain air temperature.



Weather Sensor

Model	Description
MWS	Mini Weather Station
MWSFR	MWS. w/Freeze Sensor
FREEZE	Freeze Klik

Control irrigation system operation with sensors for wind, rain, and temperature.

Rid O Rust

Rid O Rust

Model	Description
TEST8	Do it Yourself Test Kit
2650571	30gal Tank&Top/Inj System
265064	15 Gallon Tank
2662DR	55 Gallon Drum
2662GAL	Gallon
2662PA	5 Gallon Pail



Rid O Rust

Model	Description
2666GAL	Formula 2000 Gallon
2666PA	Formula 2000 5 Gallon
26881	Chemical Pump 10gpd
26505910	100gal Tank w/lid
26505965	65gal Tank w/lid
3192216	Repl Socket Assy.

Professional grade rust stain removers designed to dissolve the stain within seconds. Pre-mixed liquid or powder formula available to fit the professional's needs.

Rotating Nozzles

Hunter MP Rotator Nozzles

Model	Description
MPCORNER	Corner 8'-15'
MPLCS515	Left Strip 5'x15'
MPRCS515	Right Strip 5'x15'
MPSS530	Side Strip 5'x30'
MPTOOL	Adjustment Tool
MP1000210	8'-15' 210°-270°
MP1000360	8'-15' 360°
MP100090	8'-15' 90°- 210°
MP2000210	13'-21' 210°- 270°
MP2000360	13'-21' 360°
MP200090	13'-21' 90°- 210°
MP3000210	22'-30' 210°- 270°
MP3000360	22'-30' 360°
MP300090	22'-30' 90°- 210°
MP350090	33'-35' 90°- 210°



Water Conservation Tool. Multi-trajectory rotating streams provide unmatched uniformity. Automatic matched precipitation. Low application rate reduces runoff on slopes & tight soils.

Rain Bird Rotary Nozzles

Model	Description
R1318F	13'-18' Full
R1318H	13'-18' Half
R1318Q	13'-18' Quarter
R1318T	13'-18' One Third
R1318TQ	13'-18' Three Qtr.
R1318TT	13'-18' Two Thirds
RVAN1318	13'-18' Adj. 45°-270°
R1724F	17'-24' Full
R1724H	17'-24' Half
R1724Q	17'-24' Quarter
R1724T	17'-24' One Third
R1724TQ	17'-24' Three Qtr.
R1724TT	17'-24' Two Thirds
RVAN1724	17'-24' Adj. 45°-270°

Provide unsurpassed design flexibility and highly efficient water distribution from 13 to 24 feet.

REAMS

www.reams.net

Rotors - Hunter



PGJ	
Model	Description
PGJ04	4" Pop-Up
PGJ06	6" Pop-Up
PGJ12	12" Pop-Up

All the features and benefits of the [PGP](#), scaled down to fit typical spray applications



I-20 Ultra	
Model	Description
I2004	I-20 Adj to 360° w/Check Valve
I2004SS	I-20 Adj to 360° w/Check Valve - Stainless
I-20-12	I-20 - 12" Pop-Up

18 nozzles, 17 to 46 foot radius, 6 body choices. Also automatic arc return; non-reversing 360, from 50 to 360 degrees, a non-strippable, vandal-proof drive mechanism, FloStop® control, easy through-the-top arc adjustment, and a standard drain-check valve all equate to one prime product.



I-25 Plus	
Model	Description
I2504	I-25 4" 360°/ADJ
I2504SS	I-25 4" 360°/ADJ SS
I2504SSHS	I-25 4" 360°/ADJ SS HS
I2506	I-25 6" 360°/ADJ
I2506SS	I-25 6" 360°/ADJ SS
I2506SSHS	I-25 6" 360°/ADJ SS HS

A commercial rotor w/radius of 40' to 71', 5-year warranty and standard check valve. Available in Stainless Steel and in High Speed.



PGP	
Model	Description
PGSADJ	PGS - Shrub Head
PGP04	PGP Ultra - Adj to true 360°
PGPATR	PGP Impact Replacement
PGPADJB	PGP - Adjustable
PGPADJB2	PGP - Adjustable 2 gpm
PGPADJB2.5	PGP - Adjustable 2.5 gpm
PGPADJB3	PGP - Adjustable 3 gpm
PGPADV	PGP w/Check Valve
PGP12CV	PGP Ultra ADJ - 12" w/Check
PGH36V	PGH 360° 12" w/Check Valve
052332	Low Angle Noz Set

The world's best selling residential and light commercial rotor sets the standards for an entire industry.



I-40 Plus	
Model	Description
I4004SS	Adj to 360° w/Check Valve - Stainless
I4004SSON	Adj to 360° w/Check Valve - Stainless - Opposing Nozzle
I4004SSHS	Adj to 360° w/Check Valve - Stainless - High Speed

A tough SS commercial rotor that delivers with accuracy at watering distances up to 70 feet.

Hunter®

REAMS

www.reams.net

Rotors - Hunter



I-60	
Model	Description
I60ADS	I-60 ADS
I6036S	I-60 36S

A large turf rotor that meets the demands of systems with lower pressures and smaller budgets.



I-90	
Model	Description
I90ADV	I-90 ADV w/Check Valve
I9036V	I-90 360° w/Check Valve

Industry's longest distance rotary sprinkler specifically designed for parks, sports fields, public areas.



ST-System	
Model	Description
ST-90	3" Pop up, Adjustable Jar Top, Plastic
STG-900	3" Pop up, Adjustable Top Service, Plastic
ST-1600B	5" Pop up, Adjustable Top Service, Stainless
ST173026B	Vault for STG-900
ST243642B	Vault for ST-1600

The Hunter ST System is the first and only cost-effective integrated solution designed to exceed the unique and specific needs of the synthetic turf irrigation market.

Rotors - Rain Bird Impacts



Maxi Paw	
Model	Description
2045A	Maxi Paw

Ideal for dirty water applications with spacing up to 45 feet.



25 BPJ	
Model	Description
25BPJ-FP-ADJ	25BPJ-FP-ADJ-DA-TNT



Maxi Bird	
Model	Description
2045PJ	Maxi Bird

Spacing up to 45 feet. For above ground applications.



35A	
Model	Description
35A-PJADJ	35A-PJADJ-TNT



www.reams.net

Rotors - Rain Bird



3500

Model	Description
-------	-------------

3504PC	3504 Part/Reverse Full
--------	------------------------

Easy to use short to mid-range 1/2" inlet gear-drive rotor sprinkler, offering value and top adjustment convenience for residential and light commercial sites with spacing up to 35 feet.

5004

Model	Description
-------	-------------

5004PC	4" Pop-Up - Part Circle
5004FC	4" Pop-Up - Full Circle
5004PC2	4" Pop-Up PC w/2.0 Noz
5004PC3	4" Pop-Up PC w/3.0 Noz
5004PCSS	4" PC Stainless Steel
5004FCSS	4" FC Stainless Steel
5006PC	6" Pop-Up - Part Circle
5004PCR	4" Part Circle w/PRS
5004FCR	4" Full Circle w/PRS

Same features as the 5000 Plus without the flow shut-off feature. 5004 PRS Rotors feature a Pressure Regulated Stem that outputs a constant 45 psi at the nozzle.



5004 Plus

Model	Description
-------	-------------

5004PLP	4" Pop-Up - Part Circle
5004PLPR	4" Pop-Up PC w/PRS
5004PLP2R	4" Pop-Up PC w/PRS 2.0
5004PLP3R	4" Pop-Up PC w/PRS 3.0
5004PLF	4" Pop-Up - Full Circle
5004PLF3	4" Pop-Up FC w/3.0 Noz
5004PLFR	4" Plus Full Circle w/PRS
5004PLP2	4" Pop-Up PC w/2.0 Noz
5004PLP3	4" Pop-Up PC w/3.0 Noz
5004PLSS	4" PC Stainless Steel
5004PLPSAM 20R	4" Plus Part Circle w/PRS w/2.0 Noz
5004PLPSAM 30R	4" Plus Part Circle w/PRS w/3.0 Noz
5006PLSS	6" PC Stainless Steel
5006PLP	6" Pop-Up - Part Circle
5012PLP	12" Pop-Up - Part Circle

The Next Evolution in Rotor Performance. Rugged mid-range 3/4" inlet gear-drive rotor sprinkler, offering durability, Rain Curtain nozzle performance, flow shut-off and top adjustment convenience for residential, commercial and athletic field sites with spacing up to 50 feet. Now available with optional in-stem pressure regulation (PRS).

5500

Model	Description
-------	-------------

5505	Full/Part Circle
5505SS	Full/Part Circle SS

Durability and performance in a commercial rotor package designed to excel in short to mid-range applications.



8005

Model	Description
-------	-------------

8005	Full/Part Circle
8005SS	Full/Part Circle SS

Commercial applications like athletic fields, schools, parks and other large turf applications with spacing up to 80 feet.



6504/Falcon

Model	Description
-------	-------------

F4FC	6500 - 360°
F4PC	6500 - Adjustable
F4FCSS	6500 - 360° Stainless
F4PCSS	6500 - ADJ Stainless

A heavy-duty, closed case rotor sprinkler with optional stainless steel riser. Commercial applications with spacing up to 65 feet.



Saddles - Poly Pipe



Dawn Saddle

Model	Description
KT007C	Kwik Tap 3/4" x 1/2"
KT010C	Kwik Tap 1" x 1/2"
KT010SWS	Kwik Tap 1" x Swing
75C	3/4" x 1/2"
100C	1" x 1/2"
100D	1" x 3/4"
125D	1 1/4" x 1/2"
125D	1 1/4" x 3/4"
PE 209	1 1/2" x 1/2"
PE 210	1 1/2" x 3/4"
PE 211	1 1/2" x 1"
SS SPEEDY	Speedy Nut Driver
ND375	ND375 Nut Driver
HCTCOMBO	HC45 Hole Cutter

Blazing Saddle

Model	Description
BS5000	3/4" x 1/2"
BS7000	1" x 1/2"
BS8000	1" x 3/4"
BS9000	1" x Swing Pipe
BS12500	1 1/4" x 1/2"
BS1275P	1 1/4" x 3/4" PVC
BS12750	1 1/4" x 3/4"
BS12900	1 1/4" x Swing
BS15500	1 1/2" x 1/2"
BS1575P	1 1/2" x 3/4" PVC
BS15750	1 1/2" x 3/4"
BS15900	1 1/2" x Swing
BS5PVC	3/4" PVC x 1/2" Fipt
BS7PVC	1" PVC x 1/2" Fipt
BS8PVC	1" x 3/4" F PVC



29 Blazing Saddle models from 3/4" to 1 1/2"



These self tapping saddles means no clamping, coring, or cutting while saving time.

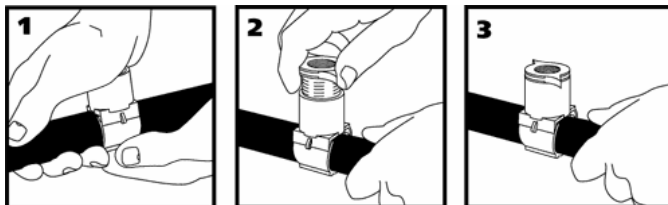

King Saddle

Model	Description
KT 22310	Snap tap 1 x 1/2"

These self tapping saddles means no clamping, coring, or cutting while saving time.

Spray Heads - Hunter

Pro-Spray

Model	Description
PROS02	2" Pop-Up
PROS03	3" Pop-Up
PROS04	4" Pop-Up
PROS04CV	4" Pop-Up w/check
PROS04PRS30	4" Pop-Up 30 psi
PROS04PRS40CV	4" Pop-Up 40 psi w/check
PROS06	6" Pop-Up
PROS06CV	6" Pop-Up w/check
PROS06NSI	6" Pop-Up No Side Inlet
PROS06PRS30	6" Pop-Up 30 psi
PROS06PRS40CV	6" Pop-Up 40 psi w/check

30psi optimized for Spray Nozzles. 45psi optimized for Rotary Nozzles.



Pro-Spray

Model	Description
PROS12	12" Pop-Up
PROS12CV	12" Pop-Up w/check
PROS12PRS30	12" Pop-Up 30 psi

PS-04

Model	Description
PS0410A	4" Pop-Up 10' Adj
PS0412A	4" Pop-Up 12' Adj
PS0415A	4" Pop-Up 15' Adj
PS0417A	4" Pop-Up 17' Adj
PS045SS	4" Pop-Up Side Strip

Spray Heads - Rain Bird

1800

Model	Description
1802	2" Pop-Up
1803	3" Pop-Up
1804	4" Pop-Up
1806	6" Pop-Up
1812	12" Pop-Up

1800 PRS (Pressure Regulating Stem)

Model	Description
1804PRS	4" Pop-Up 30psi
1806PRS	6" Pop-Up 30psi
1812PRS	12" Pop-Up 30psi
1804PRS45	4" Pop-Up 45psi

30psi optimized for Spray Nozzles. 45psi optimized for Rotary Nozzles.



1800 SAM (Seal-A-Matic)

Model	Description
1804SAM	4" Pop-Up
1806SAM	6" Pop-Up
1812SAM	12" Pop-Up

1800 SAM-PRS

Model	Description
1804SAMPRS	4" Pop-Up
1804SAMP45	4" 45psi
1806SAMPRS	6" Pop-Up
1812SAMPRS	12" Pop-Up

1800 Accessories

Model	Description
1800EXT	1800 6" Extension
1800NP	1800 NP Cap

REAMS

www.reams.net

Swing Pipe / Fittings

Blu-Lock®

HYDRO-RAIN®
Built for Speed™

Save up to 80% of your irrigation assembly time by using quick-release Blu-Lock fittings. The breakthrough “push-and-go” design eliminates tools, clamps, glue, and all of the twisting, shoving, and pounding that traditional fittings usually require.



Fittings/Tools

Model	Description
37900	1/2" BL x Swing Pipe
37970	1/2" BL x 1/2" MPT Ell
37971	1/2" BL x 3/4" MPT Ell
37974	1/2" BL x 1/2" MPT
37975	1/2" BL x 3/4" MPT
37670	1" BL Tee
37671	1" BL x 1/2" FPT Tee
37672	1" BL x 1/2" BL Tee
37673	1" BL Ell
37675	1" BL x 1/2" FPT Ell
37676	1" BL CPLG
37678	1" BL x 1" MPT
26113	Blu Lock Cutter

Saddles/Pipe

Model	Description
37980	1/2"x100' Pipe
37692	1"x300' Pipe
02917	1" Nitro Saddle Body
02918	1/2" BL Nitro Saddle Tap
02919	1/2" FIPT Saddle Tap



REAMS

www.reams.net

Swing Pipe / Fittings



SWING PIPE

Model	Description
EHF1295-010-D	Irritrol Swing Pipe
SPXFLEX	Rain Bird FLEX Swing Pipe

Dawn SWING PIPE

Model	Description
SW1413073	1/2" Swing Ell
SW1413073100	1/2" Ell Canister of 100
SW 1413099	3/4" Swing Ell
SW141309975	3/4" Ell Canister of 75
SW 1401003	Swing Tee
SW 1429003	Swing Coupler



RB Swing Pipe Fittings

Model	Description
SBE050	SBE 050 - 1/2" Ell
SBE075	SBE 075 - 3/4" Ell
SBE050B	SBE 050 - BULK 500 units
SBE075B	SBE 075 - BULK 550 units
SBA050	SBA 050 - 1/2" Male Adapter
SBA075	SBA 075 - 3/4" Male Adapter
SBFE050	SBFE 050 - 1/2" Ell - Fipt
SBCPLG	Swing Coupler
SBTEE	SB TEE - Swing Tee
SBNPTTEE	SB TEE - Barb x Barb x MPT

Swing Joints

SPEARS Swing Joint

Model	Description
5806010	1" Spig x Mipt -10"
5806015	1 1/2" Spig x Mipt -10"
5807010	1" Mipt x Mipt -8"
5807011	1" Mipt x Mipt -12"
5807015	1 1/2" Mipt x Mipt -12"



Hunter Swing Joints Mipt x Mipt

Model	Description
SJ-506	1/2" x 6"
SJ-512	1/2" x 12"
SJ-712	3/4" x 12"
SJ-7512	1/2" x 3/4" x 12"

Dura Swing Joint

Model	Description
E00810	3/4" Mipt x Mipt -10"
1A1318	1" Mipt x Mipt -8"
1A13112	1" Mipt x Mipt -12"
3A13112	1 1/2" Mipt x Mipt -12"



LASCO Swing Joint

Model	Description
G132100	1" Mipt x Mipt Kit
G132208	1" Mipt x Mipt -8"
G132212	1" Mipt x Mipt 12" Nipple
G332212	1 1/2" Mipt x Mipt -12"
G34A212	1 1/2 x 1 1/4" ACME -12"

Tapes/Teflon



Electrical Tape

Model	Description
3M1700ET	Electrical Tape
EL3M35WHT	White Electrical Tape



Teflon Tape

Model	Description
017117	1/2" x 520'
86021	3/4" x 520'



Duct Tape 2"

Model	Description
DUCTTAPE	Duct Tape 2"



Teflon Paste

Model	Description
TC ULTSEAL	Ultra Seal - Pint
TC ULTRA	Ultra Seal
WH 2030	TFE Paste - 4 Fl. Oz.
WH 23045	TFE Paste - 8 Fl Oz
WH 23060	TFE Paste - Pint

Tools



Hand Pump

Model	Description
BS 136PF6	36" Hand Pump w/6' Hose
48036	King 36" Utility Pump with 36" Hose
48072	King 36" Utility Pump with 72" Hose



Channel Locks

Model	Description
420G	9 1/2" Channel Lock
440G	12" Channel Lock
460G	16" Channel Lock
GJP100	10" Groove Plier
GJP120	12" Groove Plier
GJP160	16" Groove Plier



Valve Keys

Model	Description
DS 2160015	15" Valve Key Rubber Grip
DS 2160030	30" Valve Key Rubber Grip
NS 152	30" Valve Key
DS 2160054	54" Valve Key Rubber Grip
KEY04	Four Way Kwik Key



Probe

Model	Description
DS 2170036	36" Probe Rubber Grip
DS 2170060	60" Probe Rubber Grip



REAMS

www.reams.net

Tools



Tamper

Model	Description
SS TAMPER	8" Sod Tamp

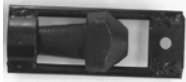

Pipe Grip

Model	Description
BDC3003	Poly Pipe Grip
DPP01	1" Dual Pipe Puller
DPP15	1 1/2" Dual Pipe Puller
DPP02	2" Dual Pipe Puller



Cable Saw

Model	Description
SCS48	48" Cable Saw
RS32	Dawn Rope Saw



Measuring Wheel

Model	Description
85703	Groundscaper 3' Wheel
85713	Pro Grade 3' Wheel

Flags

Model	Description
21AFLAG	21" American Flag
FLAG15"	15" Flags - 4 x 4" Plain
21HUNT	21" Flags - 4 x 4" Hunter
21RAIN	21" Flags - 4 x 4" Rain Bird
PERSON21"	21" Personalized Flag

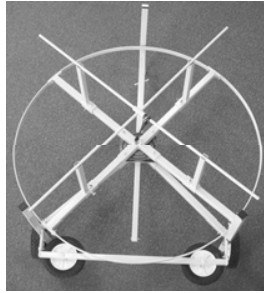

Pipe Reel

Model	Description
DOU300	300D Pipe Reel
DSWHEEL	Wheels for Reel



Stub Wrench

Model	Description
SW0500B	1/2" & 3/4" Stub Wrench
NE005	Dawn 1/2" & 3/4" Stub Wrench
NS 147	1" & 1 1/4" EZ Out
UT65001	1" EZ Out Corona
UT65002	1/2" EZ Out Corona



King Wire Mesh Grip

Model	Description
KT 81901	3/4 - 1" Mesh Grip
KT 81921	1 1/4" Mesh Grip



Marking Paint

Model	Description
P20SBL	20 oz Can - Blue
P20FOR	20 oz Can - Orange
P20HPK	20 oz Can- Pink
P20SWH	20 oz Can - White
FL MARKGU-GUN	Marking Gun - Long GUN



Pick

Model	Description
VB 64151	Pick



Broom

Model	Description
GM534	24" Push Broom

Tools

Rakes



Model	Description
GP151	23" Spring Rake - Aluminum
MR12036	36" Landscape Rake
MR12042	42" Landscape Rake

Shovel - Trenching



Model	Description
104	4" - Wood Handle
903PF	3" - Polymer Handle
904PF	4" - Polymer Handle
905PF	5" - Polymer Handle



Pipe Cutter

Model	Description
T100-O	T100 Kwikcut
T135-O	T135 Kwikcut
SS200	SS200 Kwikcut
SB5000	Blazing Cutter
RC1000	Ratcheting Pipe Cutter
RC7000	Lrg Ratcheting Cutter



Pipe Cutter Blade

Model	Description
BT100	BT 100 Blade
BT100SS	BT 100 SS Blade
BT 125	BT 125 Blade
BT135	BT 135 Blade
BT135SS	BT 135 SS Blade
BT 150	BT 150 Blade
BT200SS	BT 200 SS Blade
BL5001	Blazing Blade
BL5010	Blazing Blade 10 Pack



Pipe Wrench



Model	Description
01-618	18" Alum. Pipe Wrench
01-624	24" Alum. Pipe Wrench

Shovel - Drain Spade



Model	Description
914PF	14" - Polymer D Handle
UT47202	D Handle-Wood
UT47604	D Handle-Fiber Red

Shovel - Garden Spade



Model	Description
994PF	Garden Spade 48" Handle
996PF	Garden Spade D Handle

Shovel - Snow



Model	Description
49012	18" Snow Shovel
49014	24" Snow Pusher

Shovel - Round Point



Model	Description
950PF	Round Point - Fiberglass Handle

Pincer



Model	Description
14100082	Standard Pincer 1098
14100084	Long Handle Pincer
14100083	Side Jaw - Pincer
CT108	8" Dawn Crimper
CT112	12" Dawn Crimper
A2005	Murray Crimper

Tools



Towels

Model	Description
TCRAGS	12 - Pack of Terry Towels



Hose Nozzles

Model	Description
RB L29C	Brass Power Nozzle
RBPHEN075P	Hot Shot Hose Nozzle

Iron Clad Gloves

Model	Description
IC HUM	Glove - Medium
IC HUL	Glove - Large
IC HUXL	Glove - XL



Ring Base / Roller Base

Model	Description
RB 1901434	RB-14 3/4" Roller Base
RB 18-1	RB-18 1" Roller Base



Maxi Paw Wrench

Model	Description
42064	Maxi / Mini Paw Wrench



Knee Pads

Model	Description
KP1	Knee Pads

4-in-1 Screwdriver

Model	Description
CT 4N1TC	4-in-1
RB SD6	6-in-1



Pressure Gauge

Model	Description
EILPG1602-4L	160# Pressure Gauge
41052	Silcock Adapter

Torch

Model	Description
DT1000	Torch High Intensity Tip



Mallet

Model	Description
61-136	24oz Dead Blow Mallet
DBH15	Dawn Dead Blow Hammer



REAMS

www.reams.net

Tools

Saws

Model	Description
SH#33	#33 Hacksaw
SH#33-1	Handisaw Blades
GS13	13" Dawn Hand Saw
GS18	18" Dawn Hand Saw
HS43312	12" Christy Handy Saw
HS43312BL	12" Christy Blade

Tote Trays

Model	Description
1025	Tote Tray 1025
1025XD	1025 Divider
1050	Tote Tray 1050
1050XD	1050 Divider
1075	Tote Tray 1075
1075XD	1075 Divider
PT005	Dawn Kwik Tote



Wire Stripper

Model	Description
46005	Wire Stripper
46515	Ergonomic Wire Stripper
WS1022	Dawn Wire Stripper
WS1022-ERGO	Dawn ErgoWire Stripper



Valves - Brass Manual

Ball Valve - Full Port (C x C)

Model	Description
0547111	3/4" FBVS-3
0547112	1" FBVS-3
0547113	1 1/4" FBVS-3
0547114	1 1/2" FBVS-3



Gate Valve

Model	Description
0770211	1/2" WGV-X
0770212	3/4" WGV-X
0770213	1" WGV-X
0770050	1" WGV
0770070	1 1/4" WGV
0770214	1 1/4" WGV-X
0770090	1 1/2" WGV
0770215	1 1/2" WGV-X
0770110	2" WGV
0770216	2" WGV-X
0770130	2 1/2" WGV
0770150	3" WGV
0770170	4" WGV

Valves - Brass Manual



Ball Valve Hose Bib

Model	Description
646BV03	1/2"
646BV04	3/4"



Brass Angle Valve

Model	Description
BV 6610007	3/4"
BV 6610010	1"
BV 6610012	1 1/4"
BV 6610015	1 1/2"
BV 6610020	2"

Ball Valve – Full Port (Fipt x Fipt)

Model	Description
0547102	1/2" FBV-3
0547103	3/4" FBV-3
0547104	1" FBV-3
0547105	1 1/4" FBV-3
0547106	1 1/2" FBV-3
0547107	2" FBV-3
0547108	2 1/2" FBV-3
0547109	3" FBV-3



Ball Valve w/Test Cock

Model	Description
0546720	3/4" FBV-E
0546725	1" FBV-E
0546730	1 1/4" FBV-E
0546735	1 1/2" FBV-E
0546740	2" FBV-E

Cast Iron Ring Tite Gate Valve

Model	Description
10RT2"	2" Gasketed
10RS2"	2" Threaded
10RT09	2 1/2" Gasketed
10RT3"	3" Gasketed
10RT11	4" Gasketed
10RT6"	6" Gasketed
10RT8"	8" Gasketed



Wilkins Ball Valves

Model	Description
850 3/4"	3/4" - 850
850-1"	1" - Wilkins 850
850T1"	1" - Wilkins 850 Tapped
850T2"	2" - 850 Tapped

Test Cock

Model	Description
0006630	1/8" NPT Test Cock
0006635	1/4" NPT Test Cock



Valves - Check Valves

Brass Check Valve



Model	Description
0376353	3/4"
0376354	1"
0376356	1 1/2"
0376357	2"

PVC Check Valve



Model	Description
1001-05	1/2"
1001-10	1"
1205-15	1 1/2"
S1520-20	Swing Check 2"
S1520-30	Swing Check 3"

Hunter Check Valve



Model	Description
HC5FX5F	1/2" F x F
HC5FX5M	1/2" M x F
HC7FX7M	3/4" M x F

Valves - Plastic Manual

PVC Ball Valve WHITE (Fipt x Fipt)

Model	Description
2621-005	1/2"
2621-007	3/4"
2621-010	1"
2621-012	1 1/4"
2621-015	1 1/2"
2621-020	2"
2621-030	3"
2621-040	4"



PVC Ball Valve WHITE (Soc x Soc)

Model	Description
2622-005	1/2"
2622-007	3/4"
2622-010	1"
2622-012	1 1/4"
2622-015	1 1/2"
2622-020	2"
2622-025	2 1/2"
2622-030	3"
2622-040	4"

Valves - Hunter



SRV Valve

Model	Description
SRV100G	SRV 100G -1"
SRV101G	SRV 101G -1" w/ Flow
SRV100GS	SRV 100G (Soc x Soc)
332100	Diaphragm
606800	Solenoid



HPV Valve

Model	Description
05266902	Diaphragm
606800	Solenoid

HPV Complete Valve is no longer available. Only Solenoid and Diaphragm.

PGV Valve

Model	Description
PGV100G	PGV 100G - 1"
PGV101G	PGV 101G - 1"
PGV100A	PGV 1" Angle Valve
PGV100MB	PGV - 1" Male x Barb
PGV101MM	PGV - 1" Male x Male
PGV151	PGV 151 - 1 1/2"
PGV201	PGV 201 - 2"
332100	1" Diaphragm
414100	1 1/2" Diaphragm
415600	2" Diaphragm
606800	Solenoid

PGV Jar-Top

Model	Description
PGV100JT	1" Jar-Top FPT
PGV101JT	1" Jar-Top FPT w/Flow
PGV100JTMB	1" Jar-Top MB
PGV101JTMB	1" Jar-Top MB w/Flow
PGV100MB125	1" Male x 1 1/4" Barb
PGV100JTMM	1" Jar-Top MM
PGV101JTMM	1" Jar-Top MM w/Flow
PGV100JTSS	1" Jar-Top Slip
PGV101JTSS	1" Jar-Top Slip w/Flow



IBV Brass Valve

Model	Description
IBV101G	1" Globe Valve
IBV151G	1 1/2" Globe Valve
IBV151GFS	1 1/2" w/Filter Sentry
IBV201G	2" Globe Valve
IBV301GFS	3" w/Filter Sentry
HTS16304	Solenoid



Hunter

REAMS

www.reams.net

Valves - Hunter

ICV Valve

Model	Description
ICV101G	ICV 101G - 1"
ICV151G	ICV 151G - 1 1/2"
ICV201G	ICV 201G - 2"
ICV201FS	ICV 2" w/Filter
ICV301G	ICV 3" Globe/Angle
ICV301FS	ICV 3" w/Filter
606800	Solenoid
387800	1" Diaphragm
374500	1 1/2" & 2" Diaphragm



Hunter



AccuSync

Model	Description
AS-ADJ	Regulate psi from 20-100
AS-20	Fixed 20psi - Micro Irrigation
AS-30	Fixed 30psi - Sprays
AS-40	Fixed 40psi - MP Rotators
AS-50	Fixed 50psi - Mid Rotors
AS-70	Fixed 70psi - Large Rotors

The Accu-Sync fits on a Hunter [ICV](#) or Large [PGV](#) valve. Regulate pressures anywhere from 20 to 100 PSI

Valves - Irritrol

700 Series

Model	Description
700B-.75	700 - 3/4"
700-1	700 - 1"
700-1.5	700 - 1 1/2"
700-2	700 - 2"



2400 / 2600

Model	Description
2400T	2400T - 1"
2400TF	2400TF - 1" w/Flow Control
2600T	2600T - 1" Angle Valve
100236	Diaphragm



205 Series

Model	Description
205T	205T - 1"
205TF	205TF - 1" w/Flow Control
100232	Diaphragm
R811	Solenoid 24V



100 Series

Model	Description
IR100P1	100 - 1"
IR100P1.5	100 - 1 1/2"
IR100P2	100 - 2"
IR100P3	100 - 3"



Irritrol Solenoid fits all Irritrol Valves

Valves - Rain Bird

100 DV



Model	Description
75DV	075 DV -3/4"
100DV	100 DV -1"
100DVF	100 DV-F w/Flow Control
100DVSS	100 DV-SS (Soc x Soc) -1"
100DVFSS	100 DV-F-SS -1"
208588	DV Solenoid
210746-03	DV Diaphragm Kit



100-DV-A

100 DV Angle

Model	Description
100DVA	100 DV-A -1"



100 DV Mipt x Barb

Model	Description
100DVMB	100 DV-MB -1"
100DVFMB	100 DV-F-MB -1"
125DVMB	125 DV-MB-1 1/4"



Jar Top Valve JTV

Model	Description
100JTV	100 JTV 1"

PEB / PES-B Valve

Model	Description
100PEB	100 PEB -1"
100PESB	100 PES-B (Scrubber) -1"
150PEB	150 PEB -1 1/2"
150PESB	150 PES-B (Scrubber) 1 1/2"
200PEB	200 PEB -2"
200PESB	200 PES-B -2"
209532-02	Solenoid

PGA Valve



Model	Description
100PGA	100 PGA - 1"
150PGA	150 PGA -1 1/2"
200PGA	200 PGA -2"
209792	1" Diaphragm
209675	1 1/2" Diaphragm
209005	2" Diaphragm
209532-02	Solenoid



GB Valve



Model	Description
100GB	100 GB - 1"
150GB	150 GB - 1 1/2"
200GB	200 GB - 2"



BPE 3" (Brass-Plastic) Valve

Model	Description
300BPE	300 BPE - 3"
300BPES	300 BPE-S - 3"



Valves - Quick Coupler



Quick Coupler

Model	Description
QCV075	3/4" w/Metal Cover
QCV100	1" w/Metal Cover



Valve Key

Model	Description
QC075	3/4" Valve Key
QC100	1" Valve Key



Quick Coupler

Model	Description
3RC	3/4" Inlet
5RC	1" Inlet - 1 Piece
7VALVE	#7 Valve
33 DNP	33 DNP
44RC	1" Inlet - 2 Piece
44NP	44QC Non-Potable
44LRC	44QC w/ locking cover
5NP	5QC Non-Potable w/locking cover
33DLRC	33 DLRC



Hunter

Quick Coupler

Model	Description
HQ3RC	3/4" Inlet
HQ5RC	1" Inlet - 1 Piece
HQ44RC	1" Inlet - 2 Piece



Quick Coupler Keys

Model	Description
HK33	33 Key
HK44	44 Key
HK55	55K



Quick Coupler Keys

Model	Description
33DK	33 Key
44K	44 Key
55K1	55K1
7K	7K

Swivel

Model	Description
SH0	3/4" Fipt x 3/4" HST
SH1	1" Fipt x 3/4" HST
SH2	1" Fipt x 1" HST
SH3	1 1/2" Fipt x 1" HST



Valve Boxes

ECONO Valve Box

Model	Description
107BC	NDS Econo
182103	Ametek Econo
07081001	Carson Econo
182002	Green Cover - Ametek
182008	Brown Cover - Ametek
07084001	Green Cover - Carson
60	Dura Econo

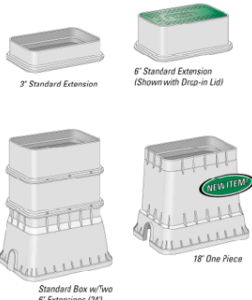

10" Round Valve Box

Model	Description
312BC	NDS 10" Rd. Box
184501	Ametek 10" Rd. Box
09101001	Carson 10" Rd. Box
181026	Ametek 3" Extension
181015	Green Cover - Ametek
VB 6020102	Brown Cover - Ametek
09104001	Green Cover - Carson
101	Dura 10" Rd. Box

12" Standard Valve Box

Model	Description
314BC	NDS 12" Standard
174501	Ametek 12" Standard
14191020	Carson 12" Standard
173134	Green Cover - Ametek
6020122	Brown Cover - Ametek
14194001	Green Cover - Carson
121	Dura 12" Standard

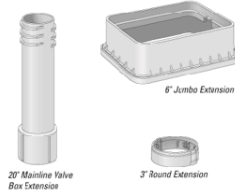

JUMBO Valve Box

Model	Description
318BC	NDS Jumbo
194502	Ametek Jumbo
12201014	Carson Jumbo
192101	Green Cover - Ametek
12204001	Green Cover - Carson
150	Dura Jumbo

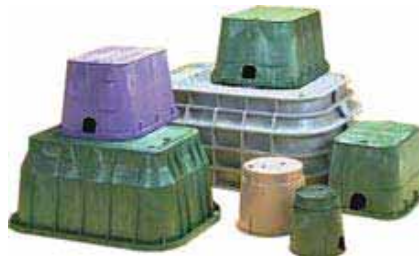

Std. Valve Box Ext. NO LID

Model	Description
170102	3" Extension - Ametek
170103	6" Extension - Ametek
14193001	6" Extension - Carson

Std. Valve Box Ext. WITH LID

Model	Description
116TBC	6" Flared Ext. - NDS
6060060	6" Flared Extension-Ametek
14191001	6" Flared Extension-Carson
121-6	6" Flared Extension-Dura



JUMBO Valve Box Ext.

Model	Description
6060150	6" Extension w/Lid A
6030152	6" Extension w/Lid C
12203001	6" Extension ONLY C
12201001	6" Valve Box - Carson

Large Utility

Model	Description
13241006	13 x 24 x 15"
13244001	Lid Only

Super Jumbo XL

Model	Description
17301005	17 x 30 x 15"
17304001	Lid Only

Water Features - Aquascape

GET YOUR FEET WET



Aquascape PRO
Professional Grade Products



The “Get Your Feet Wet” campaign offers just 3 entry-level, low-cost water features in basic kit models that are readily understood by contractors. This is a great way to get started and grow your Water Feature category!

Fountainscapes

Model	Description
-------	-------------

58065	Mongolian Basalt Column Kit
-------	-----------------------------

This 30" decorative basalt column feature is nestled atop an underground reservoir that houses the water, re-circulating pump and plumbing. There are many different features that you can put atop an Aquabasin for an easy, attractive, entry level water feature.

PRO-Fit Pondless Kits

Model	Description
-------	-------------

53011	6' Stream w/Aquasurge Pro 2000-4000
53012	16' Stream w/Aquasurge Pro 2000-4000
53005	16' Stream w/Tsurumi 3PL Pump
53013	26' Stream w/Aquasurge Pro 4000-8000
53007	26' Stream w/Tsurumi 5PL Pump

PRO-Fit Pondless Kits includes a spillway, vault, pump, AquaBlox, flex pvc, liner, underlayment, fittings, sealants, and LED Lights.

PRO-Fit Pond Kits

Model	Description
-------	-------------

53008	Small 8' x 11' Kit w/Aquasurge 3000
30394	Medium 11' x 16' Kit w/Aquasurge 3000 Pump
53000	Medium 11' x 16' Kit w/Tsurumi 3PL Pump
53001	Large 21' x 26' Kit w/Aquasurge 7000 Pump
53002	Large 21' x 26' Kit w/Tsurumi 9PL

PRO-Fit Pond Kits save time and money by pairing components together that will help to optimize the pond ecosystem and help ensure profitability when quoting jobs. Each kit includes a biofalls, skimmer, pump, flex pvc, liner, underlayment, fittings, sealants, and LED Lights.

REAMS

www.reams.net

Water Features - Aquascape

Bio Falls

Model	Description
77000	Waterfall Spillway (Diffuser)
09011	Biofalls Classic Grande
09020	Biofalls Signature 2500
29384	Biofalls Signature 6000



Aquascape's biological waterfall system provides complete mechanical and biological filtration. Designed to be buried in the ground to create the beginning of a stream or raised to create the start of a waterfall.



Pro Flex PVC

Model	Description
29021	Flex PVC 1 1/2" x 25'
29022	Flex PVC 1 1/2" x 50'
29023	Flex PVC 2" x 25'
29024	Flex PVC 2" x 50'
29025	Flex PVC 3" x 50'
29026	Flex PVC 3" x 100'
94004	1" Non-kink tubing 100'
94004-1	1" Non-kink tubing / ft.



Flexible PVC saves you time, money, and also dramatically simplifies assembly.

Retail Pro Kits

Model	Description
99763	Micro Pond Kit 4' x 6'
99764	Pond Kit 6' x 8'
99765	Micro Pond Kit 8' x 11'
99769	Micro Pondless Waterfall Kit 4' x 6'

Take the guesswork out of trying to assemble the perfect combination of equipment and liner. Each kit includes a biofalls, skimmer, pump, flex pvc, liner, underlayment, fittings, and sealants.



Water Features - Aquascape



Liner / Roll

Model	Description
29555	10' x 50'
29556	10' x 100'
29559	15' x 50'
29560	15' x 100'
29563	20' x 50'
29564	20' x 100'
29567	25' x 50'
29568	25' x 100'
29569	30' x 50'
29570	30' x 100'
29573	40' x 50'
29574	40' x 100'
29577	50' x 50'
29578	50' x 100'

Liner is 45mil EPDM and is fish safe

Liner / Custom Cut

Model	Description
29579	Custom Cut 10' x Sq.ft.
29580	Custom Cut 15' x Sq.ft.
29581	Custom Cut 20' x Sq.ft.

Underlayment

Model	Description
29169	15' x 300' Roll
29170	7.5' x 600' Roll
29227	Underlayment per Sq.ft.
NPPP60-75100	7.5' x 100' Roll MG
NPPP60-6050	6' x 50' Roll MG

Underlayment allows gas to escape while also protecting the liner from rocks and other sharp objects. 20 year life span.



Rock Pad

Model	Description
25001	15' x 150' Roll
25002	Rock Pad per Sq.ft.

Use under large rocks to protect liner from being torn.



Water Features - Aquascape



Lights



Model	Description
01002	150 Watt XFMR
84000	Pond & Landscape Light Kit
84002	6 Watt LED Spot
98926	1 Watt LED Spot
98927	3 Watt LED Spot
98928	1 Watt LED Waterfall
99070	60 Watt PC XFMR



Installation Tools

Model	Description
22003	Cover Tape 6" x 25'
22005	Cover Tape 6" x 100'
22008	Installation Kit
22010	Silicone-Black 4.7 oz.
22017	Seam Tape Dbl. Side 3" x 25"
29186	Silicone-Black 10.1 oz.
87006	Tape Primer

Pro Foam

Model	Description
21053	Foam DIY Waterfall Black
22011	Pro Gun Foam Cleaner
22013	Pro Foam Gun Kit
30096	Pro Waterfall Foam-Black
29268	Pro Foam Gun
54003	Economy Foam Gun



Expanding foam for sealing Waterfalls.



Aqua Blox Water Matrix

Model	Description
29491	Water Matrix-Small
29492	Water Matrix-Large

Use with Pondless Waterfalls and wetland systems. Replaces 90% of traditional gravel reservoir systems.



www.reams.net

Water Features - Aquascape

Filter Mats

Model	Description
29004	Sig Skim 6,8.0 Filter Mat
29010	Sig 2500 Bio Filter Mat
29073	Large Filer Mat-Classic
29078	Grande Biofall Filter Mat
29080	Standard Bio Filter Mat
29082	Mini Biofall Filter Mat
29318	Sig 6000 Bio HS Filter Mat
41203	PS SK900-1200 Filter Mat
41280	Filter Mat SK302P Skimmer
41282	Filter Mat PS Skim SK900
99216	Filter Mat-Microfall
99325	Filter Media Dense 1"x10'
99776	Filter Mat Sig Microfalls
99323	Coarse Filter Media 2"x10'

Filter Nets

Model	Description
29071	Classic Grande Skim Net
29075	Classic Lrg Skimmer Net
29146	Classic Std Skimmer Net
41206	Debris Net Skim SK900PRO
60210	Debris Net SK700PRO
99219	Microskim Net
99775	Sig Micro Skim Net

Misc. Filters & Nets

Model	Description
29003	Sig Skim Debris Basket
29074	Large Filter Rack-Classic
98465	Bio Balls 100 Pieces
99218	Brush Set-Microskim



Aquascape PRO
Professional Grade Products

REAMS

www.reams.net

Water Features - Aquascape

Skimmers



Model	Description
09017	Classic Grande
09019	Signature 6.0
29349	Signature 8.0
99771	Signature Micro



Skimmer Parts

Model	Description
29005	Stone Lid Skimmer Sig
29009	Sig. Skm 6.0 Weir Plate
29156	Fitting Manifold Kit
29214	Sig Skm 6,8,0 Slide Plate
29215	Liner Plate Sig 6,8,0
29257	Weir Skim 6" Mico,Mini, S
29260	Large Stone Skimmer Lid

Auto-Fill Valves

Model	Description
29469	Fill Valve 1/2" Hudson Kit
29647	Low Water Shutoff
29272	Water Fill 200 1/2"

Keeps the water in your feature at the optimum level.



Check Valves

Model	Description
29501	CK VLV Sig Skim/ Micropondless
29503	CK VLV Grande Skim/900SKM
29099	CK VLV 2" Double Union
29652	CK VLV Adapt. Kit-Tsurumi
29705	CK VLV 3" Double Union
99314	1/2" Check Valve Assy.

A check valve assembly is needed to connect your pump to the pond plumbing.

Snorkels

Model	Description
29064	Snorkel Vault & Cap
29065	Large Centipede
29067	Centipede End Cap
29068	Snorkel Extension
29238	Pondless Half Centipede
49000	Pondless Vault
49001	Pondless Vault Extension



Provides space for maximum water flow to pump, and also access to the pump in Pondless and wetland filtration applications.



REAMS

www.reams.net

Water Features - Aquascape



Aquabasin

Model	Description
98134	Aquabasin Large (45x45x14) 75Gal Capacity
98469	Aquabasin Small (30x30x10) 40Gal Capacity
98924	Aquabasin Mini (27x20.5x9.25) 40Gal Capacity

Great product for the entry level Water Features

Tsurumi PN Pumps

Model	Description
29495	8PN 5820 GPH Pump
30391	12PN 11500 GPH Pump

The PN series provides a good match for ponds with higher heads or require a vertical style pump housing.



De-icers

Model	Description
98151	Deicer-Floating-200W
39000	Floating Deicer 300W



AquaSurge Pumps

Model	Descriptions
91017	2000 GPH Pump
91018	3000 GPH Pump
91019	4000 GPH Pump
91020	5000 GPH Pump

Robust, reliable, efficient, and quiet with a low operating cost. 20ft. Cord.



Tsurumi PL Pumps

Model	Description
29975	3PL 3000 GPH Pump
29976	5PL 5000 GPH Pump
29977	9PL 6800 GPH Pump

Designed to be hydraulically dialed into the typical lower head water garden applications. Helps ensure ideal operating range for a longer pump life.



AquaSurge Pumps - Variable Speed

Model	Descriptions
45009	2000 - 4000 GPH Pump
45010	4000 - 8000 GPH Pump

Adjustable flow pumps available with a remote. Great for low head situations.



REAMS

www.reams.net

Water Features - Treatments

Combining science with simplicity, Aquascape's complete new and improved line of water treatments make it simple to maintain a healthy, well-balanced water garden. Aquascape's new pump top liquid bottles and bubble tabs make dosing simple and affordable. Put away your calculators and enjoy a clean, clear, healthy pond with the complete line of Aquascape water treatment products.



Pond Detoxifier

Model	Description
98876	8.5oz, treats up to 5,000 Gal
98877	16.9oz, treats up to 1,000 Gal

Reformulated EcoStarter Plus Liquid.
Makes tap water safer for fish and plants



Cold Water Beneficial Bacteria

Model	Description
98892	8.5oz, treats up to 5,000 Gal
98893	16.9oz, treats up to 10,000 Gal
98894	33.8oz, treats up to 20,000 Gal
98895	1Gal, treats up to 80,000 Gal

Reformulated AquaClearer Extreme Cold Liquid
For use in Spring or Fall. Concentrated beneficial bacteria that goes to work quickly cleaning and balancing your pond. Works at temp. below 50F. Maintains a strong biological balance providing clean, clear and healthy water conditions.

EcoBarley Liquid Extract

Model	Description
98903	8.5oz, treats up to 5,000 Gal
98904	16.9oz, treats up to 10,000 Gal
98905	33.8oz, treats up to 20,000 Gal
98906	1Gal, treats up to 80,000 Gal

Gives you a clear pond. Added enzymes will help reduce pond maintenance by breaking down pond sludge and keeping filter pads cleaner.

Sludge & Filter Cleaner

Model	Description
98889	8.5oz, treats up to 5,000 Gal
98890	16.9oz, treats up to 10,000 Gal
98891	33.8oz, treats up to 20,000 Gal

Reformulated AquaClearer Sludge Cleaner
Combination of natural cleaners helps to maintain a strong biological balance in your pond while quickly cleaning between rocks, gravel and keeping filter pads from becoming quickly clogged. Provides clean, clear and healthy water conditions.

Beneficial Bacteria - Dry

Model	Description
98925	4.4oz, treats up to 26,000 Gal
98948	8.8oz, treats up to 52,000 Gal
98949	1.1lb, treats up to 104,000 Gal
30407	9lb, treats up to 1,120,000 Gal

Reformulated AquaClearer Extreme Dry
Reduces pond maintenance. Natural cleaners helps to maintain a strong biological balance providing clean, clear and healthy water conditions.



Beneficial Bacteria - Liquid

Model	Description
98886	8.5oz, treats up to 5,000 Gal
98887	16.9oz, treats up to 10,000 Gal
98888	33.8oz, treats up to 20,000 Gal
30406	1Gal, treats up to 100,000 Gal

Reformulated AquaClearer Extreme Dry
Reduces pond maintenance. Natural cleaners helps to maintain a strong biological balance providing clean, clear and healthy water conditions.



REAMS

www.reams.net

Water Features - Treatments

Rapid Clear

Model	Description
98879	8.5oz, treats up to 5,000 Gal

Reformulated EcoFloc
Quickly clears discolored or cloudy water by clumping suspended debris. Safe for Fish. Works within 24 hours.



Natural Pond Tint

Model	Description
98884	8.5oz, treats up to 5,000 Gal

Tints water a natural Tea color. Non toxic. Ideal for Spring when pond plants have not started growing and shading water from sunlight or in summer when temps start to rise. Also helps to reduce fish stress in spring when fish have to place to hide from the sun and predators

Blue Pond Tint

Model	Description
98882	8.5oz, treats up to 5,000 Gal

Reformulated EcoShade
Safely colors pond water. Refreshing Cedar Scent. Non toxic. Ideal for Spring when pond plants have not started growing and shading water from sunlight or in summer when temps start to rise. Also helps to reduce fish stress in spring when fish have to place to hide from the sun and predators.

Pond Foam Free

Model	Description
98909	8.5oz, treats up to 5,000 Gal

Reformulated EcoFoam Away
Safely eliminates foam from ponds. Safe for fish.



SAB Stream & Pond Clean

Model	Description
98898	4.4oz, treats up to 1,300 Gal
98899	8.8oz, treats up to 2,700 Gal
98900	1.1lb, treats up to 5,600 Gal
30409	9lb, treats up to 54,000 Gal

Reformulated S.A.B. Extreme
Keeps ponds clean and crystal clear. Contains pure strains of concentrated beneficial bacteria and enzymes. Ideal for breaking down debris in ponds, streams, and waterfalls. Safe for fish.

Feature Free Foam

Model	Description
98908	8.5oz, treats up to 500 Gal

Safely eliminates foam from water features that will often build up in water features in and around fast moving water.

Feature Scale Free

Model	Description
98907	8.5oz, treats up to 500 Gal

Safely removes calcium and scale from water fountains. Refreshing lavender scent. Helps clean and clear of hard water deposits, white scale and foam. Safe for fish and plants.

IonGen

Model	Description
96020	Copper Test Kit
95012	IonGen System G2
95016	IonGen Replacement Probe G2
98881	IonGen Replacement Probe

Electronic Clarifier for Water Features
Releases a calculated mixture of copper, silver and zinc ions into the path of flowing water. The automatic control panel sends signals that slowly dissolve the replaceable metal probe. This unique combination of metal ions increases water quality, clarity, and drastically reduces time consuming maintenance.

Water Features - Treatments

Bacteria Bubble Tabs

Model	Description
98951	36 Tablets, each tablet treats up to 100 Gal
98930	72 Tablets, each tablet treats up to 100 Gal



Pond bottom and filter cleaner. Keeps pond water clean and clear. Reduces pond maintenance. Maintains a balanced EcoSystems. Safe for fish.

Spring Start Kit

Model	Description
98953	Spring Starter Kit

Everything needed to open or start your pond off right. Kit contains the following:

- Pond Detoxifier 250ml
- Cold Water Beneficial Bacteria 250ml
- Beneficial Bacteria Bubble Tabs 36 count
- Sludge and Filter Cleaner 250ml
- Pond Plant Fertilizer Tabs
- Premium Cold Water Fish Food
- Pond Thermometer
- EcoBlast Granular 8.8oz

EcoBlast

Model	Description
29311	8.8oz, treats up to 200 sq.ft.
29312	38.4oz, treats up to 780 sq.ft.
29313	7lb, treats up to 2,275 sq.ft.

Spot treatment. Fastest way to eliminate algae from waterfalls, streams, and fountains. Works best when applied directly on the algae. Fast acting and works at any water temp.



Sludge Cleaner Bubble Tabs

Model	Description
98901	36 Tablets, each tablet treats up to 100 Gal
98902	72 Tablets, each tablet treats up to 100 Gal

Pond bottom and filter cleaner. Keeps pond water clean and clear. Reduces pond maintenance. Safe for fish. Bubble tab helps disperse sludge-eating bacteria quickly.

Pond Maintenance Kit

Model	Description
98952	Pond Maintenance Kit

Pre selected products to help maintain your pond. Kit contains the following:

- Beneficial Bacteria for Ponds 125grams
- Beneficial Bacteria Bubble Tabs 36 count
- EcoBarley Liquid Extract 250ml
- Sludge and Filter Cleaner 250ml
- Rapid Clear 250ml
- EcoBlast Granular 8.8oz
- Premium Color Enhancing Fish Food
- Premium Fish Food Flakes

Wetland Pond and Lake

Model	Description
98897	1Gal, treats up to 512,000 Gal

Reformulated AquaClearer Extreme Wetland Pond and Lake Formula

Beneficial bacteria maintenance. Helps maintain a strong biological balance providing clean, clear and healthy water conditions.

Aerators

Model	Description
61000	Pond Air Pro 60
75000	Pond Air 2
75001	Pond Air 4

Pond aerators oxygenate your pond, helping create a more stable environment, resulting in healthier fish and plants.

REAMS

www.reams.net

Water Features - RainXchange

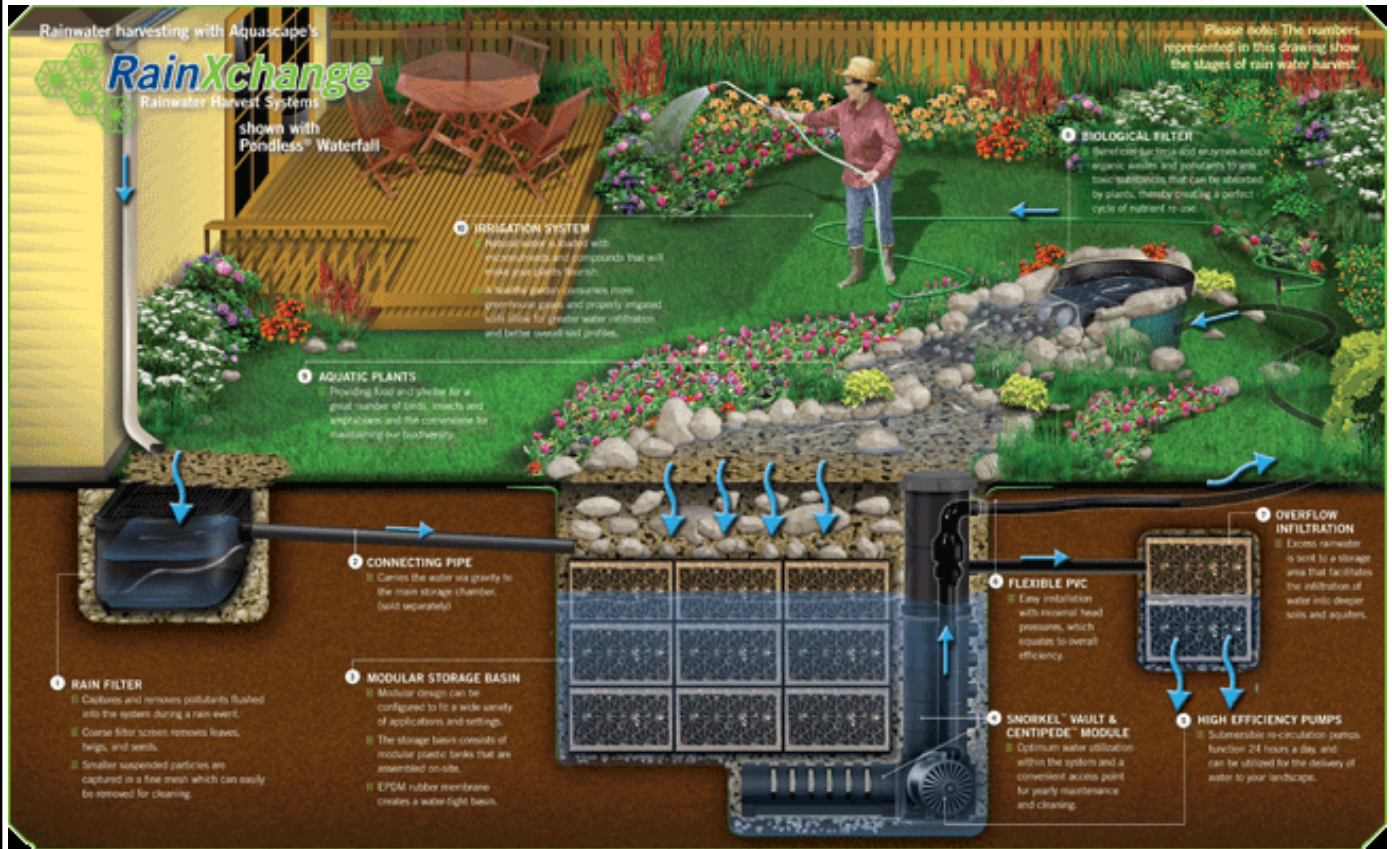

WOULD YOU RATHER HAVE THIS

OR THIS?



Traditional ways of rainwater harvesting do not add beauty or value to your home or office setting.



RainXchange™ by Aquascape Inc. adds the beauty of a water feature to a revolutionary system for capturing and reusing our most precious resource, water.

REAMS

www.reams.net

Water Features - RainXchange

WHY RAINWATER HARVEST?

The earth is known as the Blue Planet for a reason, it's no surprise that water is a dominant part of our everyday lives. The world's current challenge is to improve the planet's water quality and then maintain clean and healthy water that supports all life forms in our diverse environment.

CAPTURING AND REUSING RAINWATER MAKES DOLLARS AND "SENSE"

- Reduce water bills including city storm sewer charges
- Alleviate demand on municipal systems

Avoid strict watering schedules

BETTER FOR YOUR LANDSCAPE THAN MUNICIPALLY TREATED WATER

- Rainwater is extremely rich in nutrients
- Using rainwater to irrigate will reduce fertilizer use

No chemicals have been added to rainwater

THE RAINXCHANGE™ SYSTEM IS REVOLUTIONARY!

The Aquascape RainXchange™ System is a revolutionary design that combines a recirculating decorative water feature with a sub-surface rainwater harvest storage system.

- **Clean, Filtered Water Storage** - While you enjoy the benefits of a decorative water feature, the RainXchange™ System filters the stored water to prevent stagnation and growth of unhealthy bacteria.
- The RainXchange™ System reveals only a **beautiful water feature** that integrates easily into existing landscape.
- Locating and **storing the water underground** maintains the integrity and beauty of your home and landscape.
- **Wildlife Habitat** - Because the water stored in the RainXchange™ System is constantly moving and being aerated, it becomes a sanctuary for wildlife.
- **Water Feature Lifestyle** - Enhanced landscaping improves property value and water features provide soothing sights and sounds that help you relax and de-stress in today's busy world.
- **Environmental Conservation** - Capturing rainwater to operate the water feature creates true self-sustainability, drastically reducing the need for chemically-treated traditional water sources.

For More information on the Aquascape RainXChange system, please contact your local REAMS Representative.

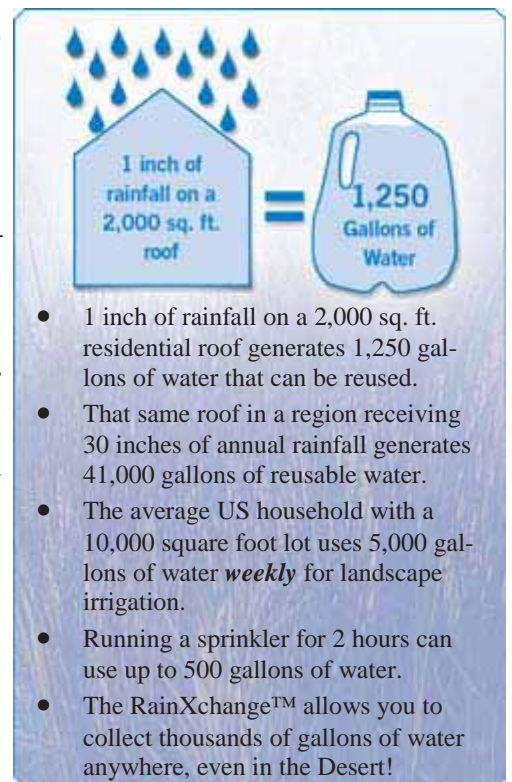

REAMS

www.reams.net

Water Features - Atlantic

Colorfall Kits

Model	Descriptions
CFKIT12W	12" Colorfall w/2000gph Pump
CFKIT24W	24" Colorfall w/3000gph Pump
CFKIT36W	36" Colorfall w/4000gph Pump

A perfect fit for formal retaining walls and pond-free applications, Colorfalls adds a breathtaking new dimension to a water feature with shimmering details in white, red or blue hues.



Colorfalls

Model	Descriptions
CF12W	12" Wide Colorfall, 1000gph
CF24W	24" Wide Colorfall, 2000gph
CF36W	36" Wide Colorfall, 3000gph

Colorfalls available in Crystal White, Ice Blue, Fire Red, and SOL White(Warm White).



Rock Lids

Model	Descriptions
RL30G	24"L x 24"W x 5"H - Great Lakes
RL40D	32"L x 30"W x 5"H - Desert
RL70M	40"L x 36"W x 10"H - Mountain
RL140S	42"L x 38"W x 10"H - Southern

Sturdy fiberglass construction paired with realistic textures and incredible finishes that fit into any region set these Rock Lids apart from anything available today. All lids available in Great Lakes, Desert, Mountain, and Southern colors

Colorfalls - Color Changing

Model	Descriptions
CC06	6" Wide Changing, 600pgh
CC12	12" Wide Changing, 1200pgh
CC24	24" Wide Changing, 2400pgh
CC36	36" Wide Changing, 3600pgh
CCCM05	Master Control Module

Atlantic's new Color Changing Colorfalls allow more water to come through with a new light bar that offer 16 different color options via remote control.

Water Features - Atlantic



Pro Series Skimmers

Model	Descriptions
PS4600	4000 GPH, Matches to BF1900 Biofalls
PS7000	7000 GPH, Matches to BF2600 Biofalls
PS15000	15000 GPH, Matches to BF3800 Biofalls

Skimmers come equipped with Super Flow weir doors, debris net and oversized brush panels that reduce maintenance.

Pro Series Filter Falls

Model	Descriptions
BF1900	2000 GPH, Matches to PS4600 Skimmer
BF2600	4000 GPH, Matches to PS7000 Skimmer
BF3800	8000 GPH, Matches to PS15000 Skimmer

Pro Series Filter Falls have all the attributes that make large-scale professional installations easy and successful.



Pro Series Fast Falls

Model	Descriptions
SP1900	19" Waterfall, 4000 GPH
SP2600	26" Waterfall, 6000 GPH
SP3800	38" Waterfall, 9000 GPH

Pro Series Filter Falls are incredibly strong one-piece units feature an internal baffling system, support ones and re-enforced spillway. The innovative "inside the liner" design and rear liner attachment, simplifies installation.



EcoBlox

Model	Descriptions
ECOBLOX	27.5"L x 16"W x 17.5"H

Eco-Blox water matrix allows for thirty-one and a half gallons of water storage for pond-free applications, bog filters and water harvesting.



Water Features - Atlantic

A Series Pumps

Model	Descriptions
-------	--------------

A-05	2000 GPH Pump
A-05L	3000 GPH Pump
A-21	4000 GPH Pump
A-31	5000 GPH Pump
A-32	7000 GPH Pump

These professional-grade pumps are engineered for high-head, high volume applications and perform where most pumps cannot.



Tidal Wave Pumps

Model	Descriptions
-------	--------------

TW1200	1200 GPH Pump
TW1900	1900 GPH Pump
TW2400	2400 GPH Pump
TW3700	3700 GPH Pump
TW4800	4800 GPH Pump
TW6000	6000 GPH Pump

Perfect for pond and waterfall applications, these pumps deliver high-volumes with direct-drive performance and magnetic-drive efficiency.



PAF Pumps

Model	Descriptions
-------	--------------

PAF-20	2000 GPH Pump
PAF-25	2500 GPH Pump
PAF-40	4000 GPH Pump
PAF-75	7500 GPH Pump

TidalWave PAF Series pumps incorporate the same high quality internal components as A-Series pumps, but are designed for medium-head, high-volume applications.



Pump Vaults

Model	Descriptions
-------	--------------

PV1800	18"W x 24"H 10,000 GPH
PV18EXT	17" High PV1800 Extension
PV2300	23"W x 30"H 15,000 GPH
PV23EXT	17" High PV2300 Extension

Heavy-Duty one piece design of Pump Vaults can accommodate large pumps and flow rates up to 15,000 gph. Features include large openings for pump access, cut lines for pump discharge and pipe extensions, and flat panels for custom plumbing applications



www.reams.net

Water Features - Atlantic



Triton Plumbing

Model	Descriptions
TR215CV	Check Valve with Union, works with 1 1/2" and 2" Pump Outlets
TR3WAY	1 1/2" fpt Inlet, 3 3/4" Outlets

The "swing style" Triton Check Valve features a 2" socket union inlet, 2" or 1-1/2" socket unions for the outlet, a molded in 90 elbow, & slim design that allows clearance when installed with direct drive pumps.

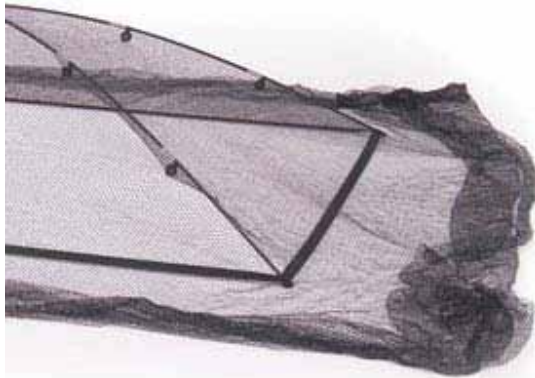

Pond & Garden Protector

Model	Descriptions
PGPSM	7' x 9' dome, 15' x 20' Net
PGPLG	9' x 12' dome, 20' x 20' Net

Protects fish from heron and other predators, Domed design covers tall plants without causing damage, Keeps falling leaves off the net for easy clean-up, Allows for sunlight and optimum plant ventilation, Helps prevent algae growth by reducing organic debris, Easy-to-assemble and remove

Matala Filter

Model	Descriptions
MA2439BLK	24"x 39" Black Sheet - Course
MA2439GRN	24"x 39" Green Sheet - Medium
MA2439BLU	24"x 39" Blue Sheet - Fine

Course, medium, and fine Matala filter mats reduce channeling, increase surface area and are back flushed more effectively than standard filter mats.



www.reams.net

Wire Connectors

DB Connectors



Model	Description
3MDBRY6BK	DBRY 600Volt Rating

3M 316



Model	Description
3M-316	316 Wire Connector

King Wire Nuts



Model	Description
KT BLACK	Black
61146	Black-150 Canister
KT BLUE	Blue
10241	Blue-100 Canister
KT TAN	Tan
20136	Tan-50 Canister

Blazing Wire Connector



Model	Description
BVS-1	Snap Lock Blue Small
BVS-2	Snap Lock Yellow Large
LV 9000	Squeeze-Lock Yellow

Sealers



Model	Description
SKOTCHKOTE	Scotchkote 15oz
DS300	DS-300 Splice Sealer

3M Wire Nuts



Model	Description
3MH30	H30 Wire Nut - Blue
3MH29	H29 Wire Nut - Gray
3MH31	H31 Wire Nut - Orange
3MRED-WIRENUT	Type R Wire Nut - Red
3MYELLOW-WIRENUT	Type Y Wire Nut - Yellow

Crimp Connectors



Model	Description
NC1610	Crimp Connector - Large
NC2212	Crimp Connector - Small

Landscape Lighting Connectors



Model	Description
KT 61335	King Black/Blue
LV 9500	Squeeze-Lock Black
NS 1525-25	Ace Connector-25 Bulk
BSC 02-25	Vista Ace Connector - 25 pairs
15529BL	Kichler Pro Series Connector w/test port
IN-10-18-20H	Lighting Shrink Ace Connector - Small/Blue
IN-8-20-T	Lighting Shrink Ace Connector - Medium/Yellow
	Lighting Shrink Crimping Tool

Wire - Irrigation

8 Gauge Wire

Model	Description
8BARE1	8 GA - BARE

10 Gauge Wire

Model	Description
10BARE-1	10 GA - BARE
10WHT2500	10 GA - White 2500'

12 Gauge Wire

Model	Description
12BLK2500	12 GA-Black 2500'
12BLU2500	12 GA-Blue 2500'
12GRN2500	12 GA-Green 2500'
12RED2500	12 GA-Red 2500'
12WHT2500	12 GA-White 2500'
12WHT500	12 GA-White 500'

16 Gauge Wire

Model	Description
16BLK1000	16 GA-Black 1000'
16BLK2500	16 GA-Black 2500'
16BLU2500	16 GA-Blue 2500'
16GRN2500	16 GA-Green 2500'
16RED2500	16 GA-Red 2500'
16WHT2500	16 GA-White 2500'
16YEL2500	16 GA-Yellow 2500'

18 Gauge Wire

Model	Description
18BLK1000	18 GA-Black 1000'

14 Gauge Wire

Model	Description
14BLK2500	14 GA-Black 2500'
14BLK500	14 GA-Black 500'
14BLU2500	14 GA-Blue 2500'
14BLU500	14 GA Blue 500'
14BRN2500	14 GA-Brown 2500'
14BRN500	14 GA-Brown 500'
14GRN2500	14 GA-Green 2500'
14GRN500	14 GA-Green 500'
14GRY2500	14 GA-Gray 2500'
14GRY500	14 GA-Gray 500'
14ORG2500	14 GA-Orange 2500'
14ORG500	14 GA-Orange 500'
14PUR2500	14 GA-Purple 2500'
14PUR500	14 GA-Purple 500'
14RED1	14 GA-Red per/ft.
14RED2500	14 GA-Red 2500'
14RED500	14 GA-Red 500'
14WHT1	14 GA-White per/ft.
14WHT2500	14 GA-White 2500'
14WHT500	14 GA-White 500'
14YEL2500	14 GA-Yellow 2500'
14YEL500	14 GA-Yellow 500'
EL 790-003	14-2 Twisted Dog Wire

Multi-Strand Wire

Model	Description
EL182-250	18-2 250'
EL182-500	18-2 500'
EL183-250	18-3 250'

Multi-Strand Wire

Model	Description
184-1000	18-4 1000'
184-250	18-4-250'
184-500	18-4 500'
185-1000	18-5 1000'
185-250	18-5 250'
185-500	18-5 500'
186-1000	18-6 1000'
186-250	18-6 250'
186-500	18-6 500'
187-1000	18-7 1000'
187-250	18-7 250'
187-500	18-7 500'
188-1	18-8 1'
188-1000	18-8 1000'
188-250	18-8 250'
188-2500	18-8 2500'
188-500	18-8 500'
189-1000	18-9 1000'
189-250	18-9 250'
189-500	18-9 500'
1810-1	18-10 1'
1810-1000	18-10 1000'
1810-250	18-10 250'
1810-2500	18-10 2500'
1810-500	18-10 500'
18121000	18-12 1000'
1812250	18-12 250'
1812500	18-12 500'

Wire - Irrigation

Multi-Strand Wire

Model	Description
-------	-------------

1813-1	18-13 1'
1813-1000	18-13 1000'
1813-250	18-13 250'
1813-500	18-13 500'
1816-1000	18-16 1000'
1816-250	18-16 250'
1816-500	18-16 500'
1819-250	18-19 250'
1819-500	18-19 500'
1825-250	18-25 250'
1825-500	18-25 500'



12 GA 2 Wire

Model	Description
-------	-------------

122-R/B-1000	12/2 Red/Blue 1000'
122-R/B-2500	12/2 Red/Blue 2500'

14 GA 2 Wire

Model	Description
-------	-------------

142-R/B-1000	14/2 Red/Blue 1000'
142-R/B-2500	14/2 Red/Blue 2500'
142-R/B-500	14/2 Red/Blue 500'
HUNTER DECODER CABLE 14/2 500'	
HUNTER DECODER CABLE 14/2 1000'	
HUNTER DECODER CABLE 14/2 2500'	

Wire - Lighting

8-2 Wire

Model	Description
8-2100	8-2 100' Roll 8 gauge
8-2250	8-2 250' Roll 8 gauge
8-2500	8-2 500' Roll 8 gauge

10-2 Wire

Model	Description
102100	10-2 100' Roll 10 gauge
102250	10-2 250' Roll 10 gauge
102500	10-2 500' Roll 10 gauge

12-2 Wire

Model	Description
122100	12-2 100' Roll 12 gauge
122250	12-2 250' Roll 12 gauge
122500	12-2 500' Roll 12 gauge



14-2 Wire

Model	Description
142100	14-2 100' Roll 14 gauge
142250	14-2 250' Roll 14 gauge
142500	14-2 500' Roll 14 gauge

16-2 Wire

Model	Description
162100	16-2 100' Roll 16 gauge
162250	16-2 250' Roll 16 gauge
162500	16-2 500' Roll 16 gauge

18-2 Wire

Model	Description
182100	18-2 100' Roll 18 gauge
182250	18-2 250' Roll 18 gauge
182500	18-2 500' Roll 18 gauge

REAMS

www.reams.net

Wire Locators & Testers



Wire Locators

Model	Description
-------	-------------

PRO290	Mini Underground Wire Locator
--------	-------------------------------

Pro290 is a great tool for contractors working with landscape lighting, invisible fencing, or any general wiring like telephone or CATV. Consists of transmitter and handheld receiver and setups up in less than a minute. 1000' distance, up to 4' deep.

PRO300	Residential Wire & Valve Locator
--------	----------------------------------

Pro300 is perfect for working primarily with smaller wired systems like residential sprinkler systems. Follow the path of the null beeps and track the wire. Should a wire be cut, the signal will stop at that point.

GFL3000	Ground Fault Locator
---------	----------------------

GFL3000 incorporates dual power output, pinpoints ground faults where electrical current is being lost to ground on underground direct buried cable. Features both high (3400v) & low (2400v) power capability.

PRO700	Wire & Valve Locator
--------	----------------------

Pro-700 incorporates a powerful transmitter and sensitive receiver, tracks irrigation wires, finds missing valves, and detects damage to vulnerable underground cabling.

PRO800	High Power Wire & Valve Locator
--------	---------------------------------

Pro800 incorporates all of the features of the standard Pro700. Additional features include Rechargeable Transmitter Battery, 20% More Transmitter Power, Wireless Broadcast Mode for Wire Tracking, 99% AC Interference/Buzz Removal, Null or Peak Tracking Receiver. Distances up to 4000 Feet and depths up to 8 Feet.

Testers

Model	Description
-------	-------------

PRO30	Digital Multimeter
-------	--------------------

Pro30 is a basic tester for identifying

PRO48	Solenoid Activator/Chatterbox Kit
-------	-----------------------------------

Activates and Holds Solenoids Open. Generates and Traces 1Khz Tracing Tone. Checks Clock 24v Power Output. Tests for Open or Shorted Wiring.

PRO48K	Solenoid Activator/Chatterbox Kit
--------	-----------------------------------

Pro48K consists of a Pro48 Solenoid Activator, the Pro210 Tone Probe, and a Pro22 carrying case

PRO93	True RMS Milliamp Clamp Meter
-------	-------------------------------

Decoders in a 2-Wire system run on milliamp sized current.

PRO220K	Tone and Probe Kit
---------	--------------------

Pro-220K is used for identifying where a particular solenoid is connected into the clock or controller.

Landscape Lighting

Model	Description
-------	-------------

PRO90	Automatic Multi-Meter
-------	-----------------------

The Pro90 Automatic Clamp Multimeter is automatic. Just connect it to the circuit to be tested and the Pro90 will automatically test for voltage from 1.3 to 600 volts AC or to 1000 volts DC. If the Pro90 multimeter does not detect any voltages, it automatically switches to resistance or ohm measurement, again auto-ranging. Contractors need multimeters for troubleshooting. The Pro90 makes identifying the type and severity of electrical problems

TECHNICAL INFORMATION

Backflow Preventer Flow Loss Chart	
009 RPZ	111
007 DC	111
PVB	111
Electric Valve Flow Loss Chart	
Hunter	112
Rain Bird	112
Irritrol	112
Landscape Lighting Technical Data	120
Polyethylene Friction Loss Chart.....	109
PVC Friction Loss Chart	
Class 160	106
Class 200	107
Schedule 40	108
Rotor Nozzle Charts	
Hunter PGP	118
Hunter I-20.....	119
Rain Bird 3500.....	116
Rain Bird 5000.....	117
Spray Nozzle Charts	
8 Series.....	113
10 Series.....	113
12 Series.....	113
15 Series.....	114
Rotary Nozzle Charts	
MP Rotator	115
Type K Copper Water Tube Friction Loss Chart.....	110
Water Features	
Pump Sizing Chart	121
Water Meter Pressure Loss	105

Pressure Loss Through Water Meters

Flow GPM	5/8"	3/4"	1"	1 1/2"	2"	3"	4"
1	0.2	0.1					
2	0.3	0.2					
3	0.4	0.3					
4	0.6	0.5	0.1				
5	0.9	0.6	0.2				
6	1.3	0.7	0.3				
7	1.8	0.8	0.4				
8	2.3	1.0	0.5				
9	3.0	1.3	0.6				
10	3.7	1.6	0.7				
11	4.4	1.9	0.8				
12	5.1	2.2	0.9				
13	6.1	2.6	1.0				
14	7.2	3.1	1.1				
15	8.3	3.6	1.2				
16	9.4	4.1	1.4	0.4			
17	10.7	4.6	1.6	0.5			
18	12.0	5.2	1.8	0.6			
19	13.4	5.8	2.0	0.7			
20	15.0	6.5	2.2	0.8			
22		7.9	2.8	1.0			
24		9.5	3.4	1.2			
26		11.2	4.0	1.4			
28		13.0	4.6	1.6			
30		15.0	5.3	1.8			
32			6.0	2.1	0.8		
34			6.9	2.4	0.9		
36			7.8	2.7	1.0		
38			8.7	3.0	1.2		
40			9.6	3.3	1.3		
42			10.6	3.6	1.4		
44			11.7	3.6	1.5		
46			12.8	4.2	1.6		
48			13.9	4.5	1.7		
50			15.0	4.9	1.9	0.7	
52				5.3	2.1		
54				5.7	2.2		
56				6.2	2.3		
58				6.7	2.5		
60				7.2	2.7		
65				8.3	3.2	1.1	
70				9.8	3.7	1.3	
75				11.2	4.3	1.5	
80				12.8	4.9	1.6	0.7
90				16.1	6.2	2.0	0.8
100				20.0	7.8	2.5	0.9
110					9.5	2.9	1.0
120					11.3	3.4	1.2
130					13.0	3.9	1.4
140					15.1	4.5	1.6
150					17.3	5.1	1.8
160					20.0	5.8	2.1
170						6.5	2.4
180						7.2	2.7
190						8.0	3.0
200						9.0	3.2
220						11.0	3.9
240						13.0	4.7
260						15.0	5.5
280						17.3	6.3
300						20.0	7.2
350							10.0
400							13.0
450							16.2
500							20.0

Friction Loss Characteristics

PVC Class 160 IPS Plastic Pipe

(1120, 1220) SDR 26 C=150

PSI Loss Per 100 Feet of Pipe (PSI/100ft.)

Size	1"	1 1/4"	1 1/2"	2"	2 1/2"	3"	4"	6"
O.D.	1.315	1.660	1.900	2.375	2.875	3.500	4.500	6.625
I.D.	1.195	1.532	1.754	2.193	2.655	3.230	4.154	6.115
Wall Thk	0.06	0.064	0.073	0.091	0.110	0.135	0.173	0.225

Flow GPM	Velocity FPS	PSI loss	Velocity FPS	PSI loss	Velocity FPS	PSI loss	Velocity FPS	PSI loss	Velocity FPS	PSI loss	Velocity FPS	PSI loss	Velocity FPS	PSI loss	Velocity FPS	PSI loss
1	0.28	0.02	0.17	0.01	0.13	0.00										
2	0.57	0.06	0.34	0.02	0.26	0.01	0.16	0.00								
3	0.85	0.14	0.52	0.04	0.39	0.02	0.25	0.01								
4	1.14	0.23	0.69	0.07	0.53	0.04	0.33	0.01	0.23	0.00						
5	1.42	0.35	0.86	0.11	0.66	0.05	0.42	0.02	0.28	0.01						
6	1.71	0.49	1.04	0.15	0.79	0.08	0.50	0.03	0.34	0.01	0.22	0.00				
7	1.99	0.66	1.21	0.20	0.92	0.10	0.59	0.03	0.40	0.01	0.27	0.01				
8	2.28	0.84	1.39	0.25	1.06	0.13	0.67	0.04	0.46	0.02	0.31	0.01				
9	2.57	1.05	1.56	0.31	1.19	0.16	0.76	0.05	0.52	0.02	0.35	0.01				
10	2.85	1.27	1.73	0.38	1.32	0.20	0.84	0.07	0.57	0.03	0.39	0.01				
11	3.14	1.52	1.91	0.45	1.45	0.23	0.93	0.08	0.63	0.03	0.43	0.01				
12	3.42	1.78	2.08	0.53	1.59	0.28	1.01	0.09	0.69	0.04	0.46	0.01	0.28	0.00		
14	3.99	2.37	2.43	0.71	1.85	0.37	1.18	0.12	0.81	0.05	0.54	0.02	0.33	0.01		
16	4.57	3.04	2.78	0.91	2.12	0.47	1.35	0.16	0.92	0.06	0.62	0.02	0.37	0.01		
18	5.14	3.78	3.12	1.13	2.38	0.58	1.52	0.20	1.04	0.08	0.70	0.03	0.42	0.01		
20	5.71	4.59	3.47	1.37	2.65	0.71	1.69	0.24	1.15	0.09	0.78	0.04	0.47	0.01		
22	6.28	5.48	3.82	1.64	2.91	0.85	1.86	0.29	1.27	0.11	0.86	0.04	0.52	0.01		
24	6.85	6.44	4.17	1.92	3.18	1.00	2.03	0.34	1.38	0.13	0.93	0.05	0.56	0.02		
26	7.42	7.47	4.51	2.23	3.44	1.15	2.20	0.39	1.50	0.15	1.01	0.06	0.61	0.02		
28	7.99	8.57	4.86	2.56	3.71	1.32	2.37	0.45	1.62	0.18	1.09	0.07	0.66	0.02		
30	8.57	9.74	5.21	2.91	3.97	1.50	2.54	0.51	1.73	0.20	1.17	0.08	0.70	0.02		
35	9.99	12.95	6.08	3.87	4.64	2.00	2.96	0.68	2.02	0.27	1.36	0.10	0.82	0.03	0.38	0.00
40	11.42	16.59	6.95	4.95	5.30	2.56	3.39	0.86	2.31	0.34	1.56	0.13	0.94	0.04	1.43	0.01
45	12.85	20.63	7.82	6.16	5.96	3.19	3.81	1.08	2.60	0.42	1.75	0.16	1.06	0.05	0.49	0.01
50	14.28	25.07	8.69	7.49	6.63	3.88	4.24	1.31	2.89	0.52	1.95	0.20	1.18	0.06	1.54	0.01
55	15.71	29.91	9.56	8.93	7.29	4.62	4.66	1.56	3.18	0.62	2.15	0.24	1.30	0.07	1.60	0.01
60	17.14	35.41	10.43	10.49	7.95	5.43	5.09	1.83	3.47	0.72	2.34	0.28	1.41	0.08	0.65	0.01
65	18.57	40.76	11.29	12.17	8.62	6.30	5.51	2.12	3.76	0.84	2.54	0.32	1.53	0.09	0.70	0.01
70	19.99	46.76	12.16	13.96	9.28	7.23	5.93	2.44	4.05	0.96	2.73	0.37	1.65	0.11	0.76	0.02
75			13.03	15.86	9.94	8.21	6.36	2.77	4.34	1.09	2.93	0.42	1.77	0.12	0.81	0.02
80			13.90	17.88	10.60	9.25	6.78	3.12	4.63	1.23	3.12	0.47	1.89	0.14	0.87	0.02
85			14.77	20.00	11.27	10.35	7.21	3.49	4.91	1.38	3.32	0.53	2.00	0.16	0.92	0.02
90			15.64	22.23	11.93	11.51	7.63	3.88	5.20	1.53	3.51	0.59	2.12	0.17	0.98	0.03
95			16.51	24.58	12.59	12.72	8.05	4.29	5.49	1.69	3.71	0.65	2.24	0.19	1.03	0.03
100			17.38	27.03	13.26	13.99	8.48	4.72	5.78	1.86	3.91	0.72	2.36	0.21	1.09	0.03
110			19.12	32.24	14.58	16.99	9.33	5.63	6.36	2.22	4.30	0.86	2.60	0.25	1.20	0.04
120					15.91	19.61	10.18	6.61	6.94	2.61	4.69	1.01	2.83	0.30	1.30	0.05
130					17.24	22.74	11.02	7.67	7.52	3.03	5.08	1.17	3.07	0.34	1.41	0.05
140					18.56	26.09	11.87	8.80	8.10	3.47	5.47	1.34	3.31	0.39	1.52	0.06
150					18.89	29.64	12.72	10.00	8.68	3.94	5.86	1.52	3.54	0.45	1.63	0.07
160							13.57	11.27	9.26	4.45	6.25	1.71	3.78	0.50	1.74	0.08
170							14.42	12.61	9.83	4.97	6.64	1.92	4.01	0.56	1.85	0.09
180							15.27	14.02	10.41	5.53	7.03	2.13	4.25	0.63	1.96	0.10
190							16.11	15.49	10.99	6.11	7.43	2.35	4.49	0.69	2.07	0.11
200							16.96	17.03	11.57	6.72	7.82	2.59	4.72	0.76	2.18	0.12
225							19.08	21.19	13.02	8.36	8.79	3.22	5.31	0.95	2.45	0.14
250									14.47	10.16	9.77	3.91	5.91	1.15	2.72	0.18
275									15.91	12.12	10.75	4.67	6.50	1.37	3.00	0.21
300									17.36	14.24	11.73	5.49	7.09	1.61	3.27	0.25
325									18.81	16.51	12.70	6.36	7.68	1.87	3.54	0.29
350											13.68	7.30	8.27	2.15	3.81	0.33
375											14.66	8.29	8.86	2.44	4.09	0.37
400											15.64	9.35	9.45	2.75	4.36	0.42
425											16.62	10.46	10.04	3.07	4.63	0.47
450											17.59	11.62	10.63	3.42	4.90	0.52
475											18.57	12.85	11.23	3.78	5.18	0.58
500											19.55	14.13	11.82	4.15	5.45	0.63
550													13.00	4.96	6.00	0.76
600													14.18	5.82	6.54	0.89

Note: Figures below **bold** line indicate velocities over 5' per second. Use with caution.

Velocity of flow values are computed from the general equation $V = .408 Q/d^2$

Friction pressure loss values are computed from the equation $[h_f = 0.2083 (100/c) 1.852 Q^{1.852}/d^{4.866}] \times .433$ for loss per 100' of pipe.

Friction Loss Characteristics

PVC Class 200 IPS Plastic Pipe

(1120, 1220) SDR 21 C=150

PSI Loss Per 100 Feet of Pipe (PSI/100ft.)

Size	3/4"	1"	1 1/4"	1 1/2"	2"	2 1/2"	3"	4"	6"
O.D.	1.050	1.315	1.660	1.900	2.375	2.875	3.500	4.500	6.625
I.D.	0.930	1.189	1.502	1.720	2.149	2.601	3.166	4.072	5.993
Wall Thk	0.060	0.063	0.079	0.090	0.113	0.137	0.167	0.214	0.316

Flow GPM	Velocity FPS	PSI loss	Velocity FPS	PSI loss	Velocity FPS	PSI loss	Velocity FPS	PSI loss	Velocity FPS	PSI loss	Velocity FPS	PSI loss	Velocity FPS	PSI loss	Velocity FPS	PSI loss	Velocity FPS	PSI loss
1	0.47	0.06	0.28	0.02	0.18	0.01	0.13	0.00										
2	0.94	0.22	0.57	0.07	0.36	0.02	0.27	0.01	0.17	0.00								
3	1.42	0.46	0.86	0.14	0.54	0.04	0.41	0.02	0.26	0.01	0.18	0.00						
4	1.89	0.79	1.15	0.24	0.72	0.08	0.55	0.04	0.35	0.01	0.24	0.01						
5	2.36	1.20	1.44	0.36	0.90	0.12	0.68	0.06	0.44	0.02	0.30	0.01						
6	2.83	1.68	1.73	0.51	1.08	0.16	0.82	0.08	0.53	0.03	0.36	0.01	0.24	0.00				
7	3.30	2.23	2.02	0.67	1.26	0.22	0.96	0.11	0.61	0.04	0.42	0.01	0.28	0.01				
8	3.77	2.85	2.30	0.86	1.44	0.28	1.10	0.14	0.70	0.05	0.48	0.02	0.32	0.01				
9	4.25	3.55	2.59	1.07	1.62	0.34	1.24	0.18	0.79	0.06	0.54	0.02	0.36	0.01				
10	4.72	4.31	2.88	1.30	1.80	0.42	1.37	0.22	0.88	0.07	0.60	0.03	0.40	0.01				
11	5.19	5.15	3.17	1.56	1.98	0.50	1.51	0.26	0.97	0.09	0.66	0.03	0.44	0.01				
12	5.66	6.05	3.46	1.83	2.17	0.59	1.65	0.30	1.06	0.10	0.72	0.04	0.48	0.02	0.29	0.00		
14	6.60	8.05	4.04	2.43	2.53	0.78	1.93	0.40	1.23	0.14	0.84	0.05	0.56	0.02	0.34	0.01		
16	7.55	10.30	4.61	3.11	2.89	1.00	2.20	0.52	1.41	0.17	0.96	0.07	0.65	0.03	0.39	0.01		
18	8.49	12.81	5.19	3.87	3.25	1.24	2.48	0.64	1.59	0.22	1.08	0.09	0.73	0.03	0.44	0.01		
20	9.43	15.58	5.77	4.71	3.61	1.51	2.75	0.78	1.76	0.26	1.20	0.10	0.81	0.04	0.49	0.01		
22	10.38	18.58	6.34	5.62	3.97	1.80	3.03	0.93	1.94	0.32	1.32	0.12	0.89	0.05	0.54	0.01		
24	11.32	21.83	6.92	6.60	4.34	2.12	3.30	1.09	2.12	0.37	1.44	0.15	0.97	0.06	0.59	0.02		
26	12.27	25.32	7.50	7.65	4.70	2.46	3.58	1.27	2.29	0.43	1.56	0.17	1.05	0.07	0.63	0.02		
28	13.21	29.04	8.08	8.78	5.06	2.82	3.86	1.46	2.47	0.49	1.68	0.19	1.13	0.07	0.68	0.02		
30	14.15	33.00	8.65	9.98	5.42	3.20	4.13	1.66	2.65	0.56	1.80	0.22	1.22	0.09	0.73	0.02	0.34	0.00
35	16.51	43.91	10.10	13.27	6.32	4.26	4.82	2.20	3.09	0.75	2.11	0.29	1.42	0.11	0.86	0.03	0.39	0.01
40	18.87	56.23	11.54	17.00	7.23	5.45	5.51	2.82	3.53	0.95	2.41	0.38	1.62	0.14	0.98	0.04	0.45	0.01
45			12.98	21.14	8.13	6.78	6.20	3.51	3.97	1.19	2.71	0.47	1.83	0.18	1.10	0.05	0.51	0.01
50			14.42	25.70	9.04	8.24	6.89	4.26	4.41	1.44	3.01	0.57	2.03	0.22	1.23	0.06	0.56	0.01
55			15.87	30.66	9.94	9.83	7.58	5.09	4.85	1.72	3.31	0.68	2.23	0.26	1.35	0.08	0.62	0.01
60			17.31	36.02	10.85	11.55	8.27	5.97	5.30	2.02	3.61	0.80	2.44	0.31	1.47	0.09	0.68	0.01
65			18.75	41.77	11.75	13.40	8.96	6.93	5.74	2.35	3.92	0.93	2.64	0.36	1.59	0.10	0.73	0.02
70					12.65	15.37	9.65	7.95	6.18	2.69	4.22	1.06	2.84	0.41	1.72	0.12	0.79	0.02
75					13.56	17.47	10.34	9.03	6.62	3.06	4.52	1.21	3.05	0.46	1.84	0.14	0.85	0.02
80					14.46	19.68	11.03	10.18	7.06	3.44	4.82	1.36	3.25	0.52	1.96	0.15	0.90	0.02
85					15.37	22.02	11.72	11.39	7.50	3.85	5.12	1.52	3.45	0.59	2.09	0.17	0.96	0.03
90					16.27	24.48	12.41	12.66	7.95	4.28	5.42	1.69	3.66	0.65	2.21	0.19	1.02	0.03
95					17.18	27.06	13.10	13.99	8.39	4.74	5.72	1.87	3.86	0.72	2.33	0.21	1.07	0.03
100					18.08	29.76	13.79	15.39	8.83	5.21	6.03	2.06	4.07	0.79	2.46	0.23	1.13	0.04
110					19.89	35.50	15.17	18.36	9.71	6.21	6.63	2.45	4.47	0.94	2.70	0.28	1.24	0.04
120							16.54	21.57	10.60	7.30	7.23	2.88	4.88	1.11	2.95	0.33	1.36	0.05
130							17.92	25.02	11.48	8.47	7.84	3.34	5.29	1.29	3.19	0.38	1.47	0.06
140							19.30	28.70	12.36	9.71	8.44	3.84	5.69	1.47	3.44	0.43	1.59	0.07
150									13.25	11.04	9.04	4.36	6.10	1.68	3.69	0.49	1.70	0.08
160									14.13	12.44	9.64	4.91	6.51	1.89	3.93	0.55	1.81	0.08
170									15.01	13.91	10.25	5.50	6.91	2.11	4.18	0.62	1.93	0.09
180									15.90	15.47	10.85	6.11	7.32	2.35	4.42	0.69	2.04	0.11
190									16.78	17.10	11.45	6.75	7.73	2.60	4.67	0.76	2.15	0.12
200									17.66	18.80	12.06	7.43	8.14	2.85	4.92	0.84	2.27	0.13
225									19.87	23.38	13.56	9.24	9.15	3.55	5.53	1.04	2.55	0.16
250											15.07	11.23	10.17	4.31	6.15	1.27	2.83	0.19
275											16.58	13.39	11.19	5.15	6.76	1.51	3.12	0.23
300											18.09	15.74	12.21	6.05	7.38	1.78	3.40	0.27
325											19.60	18.25	13.22	7.01	7.99	2.06	3.69	0.31
350													14.24	8.05	8.61	2.36	3.97	0.36
375													15.26	9.14	9.22	2.69	4.25	0.41
400													16.28	10.30	9.84	3.03	4.54	0.46
425													17.29	11.53	10.45	3.39	4.82	0.52
450													18.31	12.81	11.07	3.77	5.11	0.57
475													19.33	14.16	11.68	4.16	5.39	0.63
500															12.30	4.58	5.67	0.70
550															13.53	5.46	6.24	0.83
600															14.76	6.42	6.81	0.98

Note: Figures below **bold** line indicate velocities over 5' per second. Use with caution.

Velocity of flow values are computed from the general equation $V = .408 Q/d^2$

Friction pressure loss values are computed from the equation $[hf = 0.2083 (100/c) 1.852 Q^{1.852}/d^{4.866}] \times .433$ for loss per 100' of pipe.

Friction Loss Characteristics

PVC Schedule 40 IPS Plastic Pipe

(1120, 1220) C=150

PSI Loss Per 100 Feet of Pipe (PSI/100ft.)

Size	1/2"	3/4"	1"	1 1/4"	1 1/2"	2"	2 1/2"	3"	4"	6"
O.D.	0.840	1.050	1.315	1.660	1.900	2.375	2.875	3.500	4.500	6.625
I.D.	0.622	0.824	1.049	1.380	1.610	2.067	2.469	3.068	4.026	6.065
Wall Thk	0.109	0.113	0.133	0.140	0.145	0.154	0.203	0.216	0.237	0.280

Flow GPM	Velo FPS	PSI loss	Velo FPS	PSI loss	Velo FPS	PSI loss	Velo FPS	PSI loss	Velo FPS	PSI loss	Velo FPS	PSI loss	Velo FPS	PSI loss	Velo FPS	PSI loss	Velo FPS	PSI loss	Velo FPS	PSI loss
1	1.05	0.43	0.60	0.11	0.37	0.03	0.21	0.01	0.15	0.00										
2	2.11	1.55	1.20	0.39	0.74	0.12	0.42	0.03	0.31	0.02	0.19	0.00								
3	3.16	3.28	1.80	0.84	1.11	0.26	0.64	0.07	0.47	0.03	0.28	0.01	0.20	0.00						
4	4.22	5.60	2.40	1.42	1.48	0.44	0.85	0.12	0.62	0.05	0.38	0.02	0.26	0.01						
5	5.27	8.46	3.00	2.15	1.85	0.66	1.07	0.18	0.78	0.08	0.47	0.02	0.33	0.01	0.21	0.00				
6	6.33	11.86	3.60	3.02	2.22	0.93	1.28	0.25	0.94	0.12	0.57	0.03	0.40	0.01	0.26	0.01				
7	7.38	15.77	4.20	4.01	2.59	1.24	1.49	0.33	1.10	0.15	0.66	0.05	0.46	0.02	0.30	0.01				
8	8.44	20.20	4.80	5.14	2.96	1.59	1.71	0.42	1.25	0.20	0.76	0.06	0.53	0.02	0.34	0.01				
9	9.49	25.12	5.40	6.39	3.33	1.97	1.92	0.52	1.41	0.25	0.85	0.07	0.60	0.03	0.39	0.01				
10	10.55	30.54	6.00	7.77	3.70	2.40	2.14	0.63	1.57	0.30	0.95	0.09	0.66	0.04	0.43	0.01				
11	11.60	36.43	6.60	9.27	4.07	2.86	2.35	0.75	1.73	0.36	1.05	0.11	0.73	0.04	0.47	0.02				
12	12.65	42.80	7.21	10.89	4.44	3.36	2.57	0.89	1.88	0.42	1.14	0.12	0.80	0.05	0.52	0.02	0.30	0.00		
14	14.76	56.94	8.41	14.48	5.19	4.47	2.99	1.18	2.20	0.56	1.33	0.17	0.93	0.07	0.60	0.02	0.35	0.01		
16	16.87	72.92	9.61	18.55	5.93	5.73	3.42	1.51	2.51	0.71	1.52	0.21	1.07	0.09	0.69	0.03	0.40	0.01		
18	18.98	90.69	10.81	23.07	6.67	7.13	3.85	1.88	2.83	0.89	1.71	0.26	1.20	0.11	0.78	0.04	0.45	0.01		
20	21.09	110.2	12.01	28.04	7.41	8.66	4.28	2.28	3.14	1.08	1.90	0.32	1.33	0.13	0.86	0.05	0.50	0.01		
22			13.21	33.45	8.15	10.33	4.71	2.72	3.46	1.29	2.10	0.38	1.47	0.16	0.95	0.06	0.55	0.01		
24			14.42	39.30	8.89	12.14	5.14	3.20	3.77	1.51	2.29	0.45	1.60	0.19	1.01	0.07	0.60	0.02		
26			15.62	45.58	9.64	14.08	5.57	3.17	4.09	1.75	2.48	0.52	1.74	0.22	1.12	0.08	0.65	0.02		
28			16.82	52.28	10.38	16.15	5.99	4.25	4.40	2.01	2.67	0.60	1.87	0.25	1.21	0.09	0.70	0.02		
30			18.02	59.41	11.12	18.35	6.42	4.83	4.72	2.28	2.86	0.68	2.00	0.29	1.30	0.10	0.75	0.03		
35					12.97	24.42	7.49	6.43	5.50	3.04	3.34	0.90	2.34	0.38	1.51	0.13	0.88	0.04	0.38	0.00
40					14.83	31.27	8.56	8.23	6.29	3.89	3.81	1.15	2.67	0.49	1.73	0.17	1.00	0.04	0.44	0.01
45					16.68	38.89	9.64	10.24	7.08	4.84	4.29	1.43	3.01	0.60	1.95	0.21	1.13	0.06	0.49	0.01
50					18.53	47.27	10.71	12.45	7.87	5.88	4.77	1.74	3.34	0.73	2.16	0.26	1.25	0.07	0.55	0.01
55							11.78	14.85	8.65	7.01	5.25	2.08	3.68	0.88	2.38	0.30	1.38	0.08	0.61	0.01
60							12.85	17.45	9.44	8.24	5.72	2.44	4.14	1.03	2.60	0.36	1.51	0.10	0.66	0.01
65							13.92	20.23	10.23	9.56	6.20	2.83	4.35	0.19	2.81	0.41	1.63	0.11	0.72	0.02
70							14.99	23.21	11.01	10.96	6.68	3.25	4.68	1.37	3.03	0.47	1.76	0.13	0.77	0.02
75							16.06	26.37	11.80	12.46	7.16	3.69	5.01	1.56	3.25	0.54	1.88	0.14	0.83	0.02
80							17.13	29.72	12.59	14.04	7.63	4.16	5.35	1.75	3.46	0.61	2.01	0.13	0.88	0.02
85							18.21	33.26	13.37	15.71	8.11	4.66	5.68	1.96	3.68	0.68	2.13	0.18	0.94	0.02
90							19.28	36.97	14.16	17.46	8.59	5.18	6.02	2.18	3.90	0.76	2.26	0.20	0.99	0.03
95									14.95	19.30	9.07	5.72	6.35	2.41	4.00	0.84	2.39	0.22	1.02	0.03
100									15.74	21.22	9.54	6.29	6.69	2.65	4.33	0.92	2.51	0.25	1.10	0.03
110									17.31	25.32	10.50	7.51	7.36	3.16	4.76	1.10	2.76	0.29	1.22	0.04
120									18.88	29.75	11.45	8.82	8.03	3.72	5.20	1.29	3.02	0.34	1.33	0.05
130											12.41	10.23	8.70	4.31	5.63	1.50	3.27	0.40	1.44	0.05
140											13.36	11.74	9.37	4.94	6.06	1.72	3.52	0.46	1.55	0.06
150											14.32	13.33	10.03	5.62	6.50	1.95	3.77	0.52	1.66	0.07
160											15.27	15.03	10.70	6.33	6.93	2.20	4.02	0.59	1.77	0.08
170											16.23	16.81	11.37	7.08	7.36	2.46	4.27	0.66	1.88	0.09
180											17.18	18.69	12.04	7.87	7.80	2.74	4.53	0.73	1.99	0.10
190											18.14	20.66	12.71	8.70	8.23	3.02	4.78	0.81	2.10	0.11
200											19.09	22.72	13.38	9.57	8.66	3.33	5.03	0.89	2.21	0.12
225													15.05	11.90	9.75	4.14	5.66	1.10	2.49	0.15
250													16.73	14.47	10.83	5.03	6.29	1.34	2.77	0.18
275													18.40	17.26	11.92	6.00	6.29	1.60	3.05	0.22
300															13.00	7.05	7.55	1.88	3.32	0.26
325															14.08	8.17	8.18	2.18	3.60	0.30
350															15.17	9.38	8.81	2.50	3.88	0.34
375															16.25	10.65	9.43	2.84	4.15	0.39
400															17.33	12.01	10.06	3.20	4.43	0.44
425															18.42	13.43	10.69	3.58	4.71	0.49
450															19.50	14.93	11.32	3.98	4.99	0.54
475																	11.95	4.40	5.26	0.60
500																	12.58	4.85	5.54	0.66
550																	13.84	5.77	6.10	0.79
600																	15.10	6.78	6.65	0.92

Note: Figures below **bold** line indicate velocities over 5' per second. Use with caution.

Velocity of flow values are computed from the general equation $V = .408 Q/d^2$

Friction pressure loss values are computed from the equation $[hf = 0.2083 (100/c) 1.852 Q^{1.852}/d^{4.866}] \times .433$ for loss per 100' of pipe.

Friction Loss Characteristics

Polyethylene (PE) SDR Pressure Rated Tube
 (2306, 3206, 3306) SDR 7, 9, 11.5, 15 C=150
 PSI Loss Per 100 Feet of Pipe (PSI/100ft.)

Size I.D. 1/2" 3/4" 1" 1 1/4" 1 1/2" 2" 2 1/2" 3" 4" 6"

 0.622 0.824 1.049 1.380 1.610 2.067 2.469 3.068 4.026 6.065

Flow GPM	Velo FPS	PSI loss	Velo FPS	PSI loss	Velo FPS	PSI loss	Velo FPS	PSI loss	Velo FPS	PSI loss	Velo FPS	PSI loss	Velo FPS	PSI loss	Velo FPS	PSI loss	Velo FPS	PSI loss	Velo FPS	PSI loss
1	1.05	0.49	0.60	0.12	0.37	0.04	0.21	0.01	0.15	0.00	0.09	0.00								
2	2.10	1.76	1.20	0.45	0.74	0.14	0.42	0.01	0.31	0.02	0.19	0.01								
3	3.16	3.73	1.80	0.95	1.11	0.29	0.64	0.08	0.47	0.04	0.28	0.01	0.20	0.00						
4	4.21	6.35	2.40	1.62	1.48	0.50	0.85	0.13	0.62	0.06	0.38	0.02	0.26	0.01						
5	5.27	9.60	3.00	2.44	1.85	0.76	1.07	0.20	0.78	0.09	0.47	0.03	0.33	0.01	0.21	0.00				
6	6.32	13.46	3.60	3.43	2.22	1.06	1.28	0.28	0.94	0.13	0.57	0.04	0.40	0.02	0.26	0.01				
7	7.38	17.91	4.20	4.56	2.59	1.41	1.49	0.37	1.10	0.18	0.66	0.05	0.46	0.02	0.30	0.01				
8	8.43	22.93	4.80	5.84	2.96	1.80	1.71	0.47	1.25	0.22	0.76	0.07	0.53	0.03	0.34	0.01				
9	9.49	28.52	5.40	7.26	3.33	2.24	1.92	0.59	1.41	0.28	0.85	0.08	0.60	0.03	0.39	0.01				
10	10.54	34.67	6.00	8.80	3.70	2.73	2.14	0.72	1.57	0.34	0.95	0.10	0.66	0.04	0.43	0.01				
11	11.60	41.36	6.00	10.53	4.07	3.25	2.35	0.86	1.73	0.40	1.05	0.12	0.73	0.05	0.47	0.02	0.27	0.00		
12	12.65	48.60	7.21	12.37	4.44	3.82	2.57	1.01	1.88	0.48	1.14	0.14	0.80	0.06	0.52	0.02	0.30	0.01		
14	14.76	64.65	8.41	16.46	5.19	5.08	2.99	1.34	2.20	0.69	1.33	0.19	0.93	0.08	0.60	0.03	0.35	0.01		
16	16.87	82.79	9.61	21.07	5.93	6.51	3.42	1.71	2.54	0.81	1.52	0.24	1.07	0.10	0.69	0.04	0.41	0.01		
18	18.98	102.9	10.81	26.21	6.67	8.10	3.85	2.13	2.83	1.01	1.71	0.30	1.20	0.13	0.78	0.04	0.45	0.01		
20			12.01	31.86	7.41	9.84	4.28	2.59	3.14	1.22	1.90	0.36	1.33	0.15	0.86	0.05	0.50	0.01		
22			13.32	38.01	8.15	11.74	4.71	3.09	3.46	1.46	2.10	0.43	1.47	0.18	0.95	0.06	0.55	0.02		
24			14.42	44.65	8.89	13.79	5.14	3.63	3.77	1.72	2.29	0.51	1.60	0.21	1.04	0.07	0.60	0.02		
26			15.62	48.15	9.64	16.00	5.57	4.21	4.09	1.99	2.48	0.59	1.74	0.25	1.12	0.09	0.65	0.02		
28			16.82	59.41	10.38	18.35	5.99	4.83	4.40	2.28	2.67	0.68	1.87	0.29	1.21	0.10	0.70	0.03		
30			18.02	67.50	11.12	20.85	6.42	5.49	4.72	2.59	2.86	0.77	2.00	0.32	1.30	0.11	0.75	0.03	0.33	0.00
35					12.97	27.74	7.49	7.31	5.50	3.45	3.34	1.02	2.32	0.43	1.50	0.15	0.88	0.04	0.38	0.01
40					14.83	33.53	8.56	9.36	6.29	4.42	3.81	1.31	2.67	0.55	1.73	0.19	1.00	0.05	0.44	0.01
45					16.68	44.19	9.64	11.64	7.08	5.50	4.29	1.63	3.01	0.69	1.95	0.24	1.13	0.06	0.49	0.01
50					18.53	53.71	10.71	14.14	7.87	6.68	4.77	1.95	3.34	0.83	2.16	0.29	1.25	0.08	0.55	0.01
55							11.78	16.87	8.65	7.97	5.25	2.36	3.68	1.00	2.38	0.35	1.38	0.09	0.61	0.01
60							12.85	19.82	9.44	9.36	5.72	2.78	4.04	1.17	2.60	0.41	1.51	0.11	0.66	0.01
65							13.92	22.99	10.23	10.86	6.20	3.22	4.35	1.36	2.80	0.47	1.63	0.13	0.72	0.02
70							14.99	26.37	11.01	12.46	6.68	3.69	4.68	1.56	3.03	0.54	1.76	0.14	0.77	0.02
75							16.06	29.97	11.80	14.16	7.16	4.20	5.01	1.77	3.25	0.61	1.88	0.16	0.83	0.02
80							17.13	33.77	12.59	15.95	7.63	4.73	5.35	1.99	3.46	0.69	2.01	0.18	0.88	0.03
85							18.21	37.79	13.37	17.85	8.11	5.29	5.68	2.23	3.68	0.77	2.13	0.21	0.94	0.03
90							19.28	42.01	14.16	19.84	8.59	5.88	6.02	2.48	3.90	0.86	2.23	0.23	0.99	0.03
95									14.95	21.93	9.07	6.50	6.35	2.74	4.11	0.95	2.39	0.25	1.05	0.03
100									15.74	24.12	9.54	7.15	6.69	3.01	4.33	1.05	2.51	0.28	1.10	0.04
110									17.31	28.77	10.50	8.53	7.36	3.59	4.76	1.25	2.76	0.33	1.22	0.05
120									18.88	33.80	11.45	10.02	8.03	4.22	5.20	1.47	3.02	0.39	1.33	0.05
130											12.41	11.62	8.70	4.90	5.63	1.70	3.27	0.45	1.44	0.06
140											13.36	13.33	9.37	5.62	6.06	1.95	3.52	0.52	1.55	0.07
150											14.32	15.15	10.03	6.38	6.50	2.22	3.77	0.59	1.66	0.08
160											15.27	17.08	10.70	7.19	6.93	2.50	4.02	0.67	1.77	0.09
170											16.23	19.11	11.37	8.05	7.36	2.80	4.27	0.75	1.88	0.10
180											17.18	21.24	12.04	8.95	7.80	3.11	4.53	0.83	1.99	0.11
190											18.14	23.48	12.71	9.89	8.23	3.44	4.78	0.92	2.10	0.12
200											19.09	25.81	13.38	10.87	8.66	3.78	5.03	1.01	2.21	0.14
225													15.05	13.52	9.75	3.70	5.66	1.25	2.49	0.17
250													16.73	16.4	10.83	5.71	6.29	1.52	2.77	0.21
275													18.40	19.61	11.92	6.82	6.92	1.82	3.05	0.25
300															13.00	8.01	7.55	2.13	3.32	0.29
325															14.08	9.29	8.18	2.48	3.60	0.34
350															15.17	10.65	8.81	2.84	3.88	0.39
375															16.25	12.10	9.43	3.23	4.15	0.44
400															17.33	13.64	10.06	3.64	4.43	0.50
425															18.42	15.26	10.69	4.07	4.71	0.55
450															19.50	16.97	11.32	4.52	4.99	0.62
475																	11.95	5.00	5.26	0.68
500																	12.58	5.50	5.54	0.75
550																	13.84	6.56	6.10	0.89
600																	15.10	7.70	6.65	1.05

Note: Figures below **bold** line indicate velocities over 5' per second. Use with caution.
 Velocity of flow values are computed from the general equation $V = .408 Q/d^2$
 Friction pressure loss values are computed from the equation $[hf = 0.2083 (100/c) 1.852 Q^{1.852}/d^{4.866}] \times .433$ for loss per 100' of pipe.

Friction Loss Characteristics

Type K Copper Water Tube

C=140

PSI Loss Per 100 Feet of Tube (PSI/100ft.)

Size	1/2"	5/8"	3/4"	1"	1 1/4"	1 1/2"	2"	2 1/2"	3"
O.D.	0.625	0.750	0.875	1.125	1.375	1.625	2.125	2.625	3.125
I.D.	0.5270	0.652	0.745	0.995	1.245	1.481	1.959	2.435	2.907
Wall Thk	0.049	0.049	0.065	0.065	0.065	0.072	0.083	0.095	0.109

Flow GPM	Velocity FPS	PSI loss	Velocity FPS	PSI loss	Velocity FPS	PSI loss	Velocity FPS	PSI loss	Velocity FPS	PSI loss	Velocity FPS	PSI loss	Velocity FPS	PSI loss	Velocity FPS	PSI loss	Velocity FPS	PSI loss
1	1.46	1.09	0.95	0.39	0.73	0.20	0.41	0.05	0.26	0.02	0.18	0.01	0.10	0.00				
2	2.93	3.94	1.94	1.40	1.47	0.73	0.82	0.18	0.52	0.06	0.37	0.03	0.21	0.01				
3	4.40	8.35	2.87	2.97	2.20	1.55	1.23	0.38	0.78	0.13	0.55	0.05	0.31	0.01	0.20	0.00		
4	5.87	14.23	3.83	5.05	2.94	2.64	1.64	0.65	1.05	0.22	0.74	0.09	0.42	0.02	0.27	0.01	0.19	0.00
5	7.34	21.51	4.79	7.64	3.67	3.99	2.06	0.98	1.31	0.33	0.93	0.14	0.53	0.04	0.34	0.01	0.24	0.01
6	8.84	30.15	5.75	10.70	4.41	5.60	2.47	1.37	1.57	0.46	1.11	0.20	0.63	0.05	0.41	0.02	0.28	0.01
7	10.28	40.11	6.71	14.24	5.14	7.44	2.88	1.82	1.84	0.61	1.30	0.26	0.74	0.07	0.48	0.02	0.33	0.01
8	11.75	51.37	7.67	18.24	5.88	9.53	3.29	2.33	2.41	0.78	1.48	0.34	0.85	0.09	0.55	0.03	0.38	0.01
9	13.22	63.89	8.63	22.68	6.61	11.86	3.70	2.90	2.36	0.97	1.67	0.42	0.95	0.11	0.61	0.04	0.43	0.02
10	14.69	77.66	9.59	27.57	7.35	14.41	4.12	3.53	2.63	1.18	1.86	0.51	1.06	0.13	0.68	0.05	0.48	0.02
11	16.15	92.68	10.55	32.89	8.08	17.19	4.53	4.21	2.89	1.41	2.04	0.61	1.16	0.16	0.75	0.05	0.53	0.02
12	17.62	108.8	11.51	38.64	8.82	20.20	4.94	4.94	3.15	1.66	2.23	0.71	1.27	0.18	0.82	0.06	0.57	0.03
14			13.43	51.41	10.29	26.87	5.76	6.57	3.68	2.21	2.60	0.95	1.48	0.24	0.95	0.08	0.67	0.04
16			15.35	65.83	11.76	34.41	6.59	8.42	4.21	2.83	2.97	1.22	1.70	0.31	1.10	0.11	0.77	0.05
18			17.27	81.88	13.23	42.80	7.41	10.47	4.73	3.52	3.34	1.51	1.91	0.39	1.23	0.13	0.86	0.06
20			19.19	99.53	14.70	52.02	8.24	12.73	5.23	4.28	3.72	1.84	2.11	0.47	1.37	0.16	0.96	0.07
22					16.17	62.06	9.06	15.18	5.79	5.10	4.09	2.19	2.33	0.56	1.51	0.20	1.06	0.08
24					17.64	72.92	9.89	17.84	6.31	5.99	4.46	2.58	2.55	0.66	1.65	0.23	1.15	0.10
26					19.11	84.57	10.71	20.69	6.84	6.95	4.83	2.99	2.75	0.77	1.78	0.27	1.25	0.11
28							11.53	23.73	7.37	7.98	5.20	3.43	2.97	0.88	1.92	0.30	1.35	0.13
30							12.36	26.97	7.89	9.06	5.58	3.89	3.18	1.00	2.06	0.35	1.44	0.15
35							14.42	35.88	9.21	12.06	6.51	5.18	3.72	1.33	2.40	0.46	1.68	0.19
40							16.48	45.95	10.52	15.44	7.44	6.63	4.25	1.70	2.75	0.59	1.93	0.25
45							15.54	57.15	11.84	19.20	8.37	8.25	4.78	2.12	3.00	0.73	2.17	0.31
50							13.16	23.34	9.30	10.03	9.30	10.03	5.31	2.57	3.44	0.89	2.41	0.38
55							14.47	27.85	10.23	11.97	5.84	3.07	3.78	1.06	3.78	1.06	2.65	0.45
60							15.79	32.71	11.16	14.06	6.37	3.60	4.12	1.25	4.12	1.25	2.89	0.53
65							17.10	37.94	12.09	16.31	6.91	4.18	4.47	1.45	4.47	1.45	3.13	0.61
70							18.42	43.52	13.02	18.70	7.44	4.80	4.81	1.66	4.81	1.66	3.37	0.70
75							19.74	49.46	13.95	21.25	7.97	5.45	5.16	1.89	5.16	1.89	3.62	0.80
80										14.88	23.95	8.50	6.14	5.50	2.13	3.86	0.90	
85										15.81	26.80	9.06	6.87	5.84	2.38	4.10	1.01	
90										16.74	29.79	9.56	7.64	6.19	2.65	4.34	1.12	
95										17.67	32.93	10.09	8.44	6.53	2.93	4.58	1.24	
100										18.60	36.21	10.63	9.28	6.88	3.22	4.82	1.36	
110													11.69	11.08	7.56	3.84	5.31	1.62
120													12.75	13.01	8.25	4.52	5.79	1.91
130													13.82	15.09	8.94	5.24	6.27	2.21
140													14.88	17.31	9.63	6.01	6.75	2.54
150													15.94	19.67	10.32	6.83	7.24	2.88
160													17.01	22.17	11.00	7.69	7.72	3.25
170													18.07	24.81	11.69	8.61	8.20	3.64
180													19.13	27.58	12.38	9.57	8.69	4.04
190															13.07	10.58	9.17	4.47
200															13.76	11.63	9.65	4.91
225															15.48	14.47	10.86	6.11
250															17.20	17.58	12.07	7.43
275															18.92	20.98	13.27	8.86
300																	14.48	10.41
325																	15.69	12.07
350																	16.89	13.85
375																	18.10	15.73
400																	19.31	17.73
425																		
450																		
475																		
500																		
550																		

Note: Figures below **bold** line indicate velocities over 5' per second. Use with caution.

Velocity of flow values are computed from the general equation $V = .408 Q/d^2$

Friction pressure loss values are computed from the equation $[hf = 0.2083 (100/c) 1.852 Q^{1.852}/d^{4.866}] \times .433$ for loss per 100' of pipe.

TECHNICAL INFORMATION

BACKFLOW PREVENTERS

WATTS - RPZ

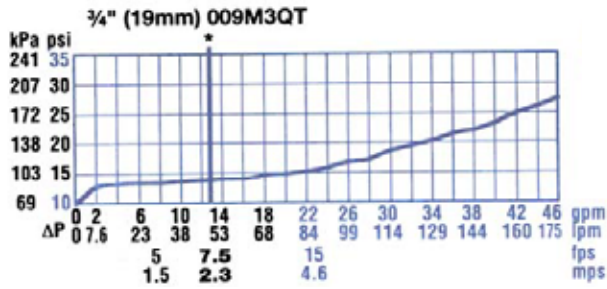

WATTS - DOUBLE CHECK

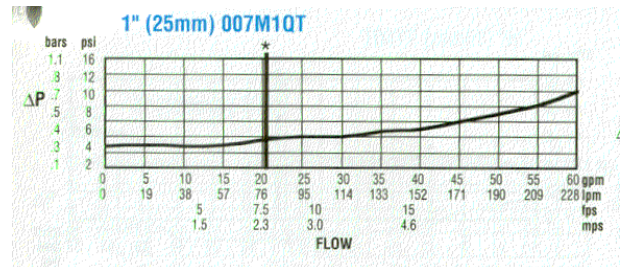
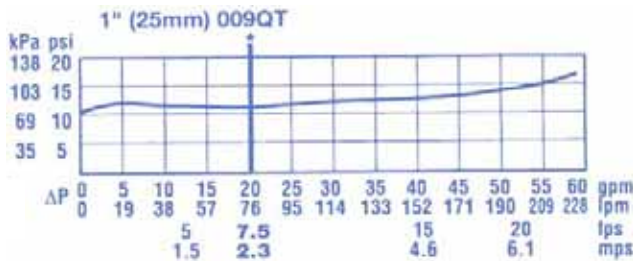
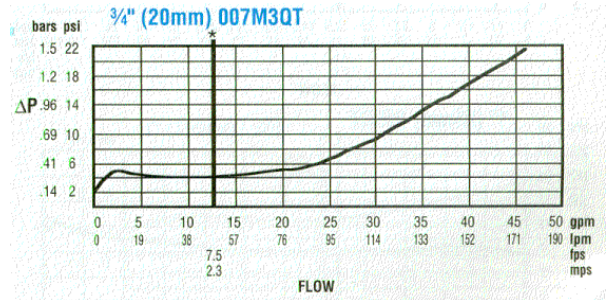

These Charts show psi loss and safe flow rates through the various backflows. Safe flow rates are based on 7.5ft/per second.

WATTS - PVB

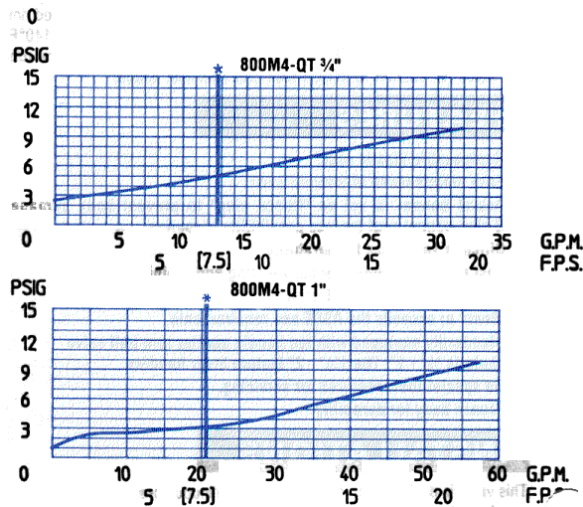

TECHNICAL INFORMATION

ELECTRIC VALVES

DV and DVF Valve Pressure Loss (psi)		
Flow gpm	075-DV ¾" psi	100-DV/100-DVF 1" psi
1	3.2	3.3
3	3.9	3.6
5	4.2	3.8
10	5.0	3.8
20	7.7	5.1
30	-	6.4
40	-	8.6

PGA Series Valve Pressure Loss (psi)						
Flow gpm	100- PGA Globe 1"	100- PGA Angle 1"	150- PGA Globe 1½"	150- PGA Angle 1½"	200- PGA Globe 2"	200- PGA Angle 2"
1	5.1	4.3	-	-	-	-
5	5.5	5.0	-	-	-	-
10	5.9	5.5	-	-	-	-
20	6.0	5.6	-	-	-	-
30	6.4	5.5	1.9	1.3	-	-
40	7.0	7.5	3.2	2.0	1.2	1.0
50	-	-	4.8	3.0	1.5	0.9
75	-	-	11.1	6.5	3.0	1.7
100	-	-	19.2	11.7	5.5	3.0
125	-	-	-	-	8.6	4.8
150	-	-	-	-	12.0	6.5





Irritrol 2400 Series	
Flow gpm	Loss psi
.25	5.00
2	4.60
5	3.50
10	4.00
15	2.97
20	3.26
30	6.20

Irritrol 205 Series	
Flow gpm	Loss psi
.25	5.40
2	3.82
5	3.00
10	2.20
15	1.90
20	3.10
30	5.00





Hunter PGV						
PSI Loss						
GPM	1" Globe	1" Angle	1 1/2" Globe	1 1/2" Angle	2" Globe	2" Angle
1	1.1	1.0				
5	1.9	1.0				
10	1.9	1.0				
15	1.6	1.0				
20	3.3	2.0	3.0	3.0	1.0	1.0
30	6.1	3.0	3.0	3.0	1.0	2.0
40			3.0	3.0	2.0	2.0
50			4.0	3.5	1.0	1.0
60			5.0	4.0	2.0	2.0
80			5.5	4.5	3.0	2.0
100					5.0	3.0
120					6.0	5.0
135					8.0	7.0
150					10.0	9.0

TECHNICAL INFORMATION

8 Series MPR 10° Trajectory







Nozzle	Pressure psi	Radius Ft.	Flow gpm	Precip In/h	Precip In/h
8F 	15	5	0.54	2.07	2.39
	20	6	0.75	2.01	2.32
	25	7	0.82	1.62	1.87
	30	8	1.05	1.58	1.83
8H 	15	5	0.27	2.07	2.39
	20	6	0.38	2.01	2.32
	25	7	0.41	1.62	1.87
	30	8	0.52	1.58	1.83
8T 	15	5	0.18	2.07	2.39
	20	6	0.25	2.01	2.32
	25	7	0.27	1.62	1.87
	30	8	0.35	1.58	1.83
8Q 	15	5	0.13	2.07	2.39
	20	6	0.19	2.01	2.32
	25	7	0.21	1.62	1.87
	30	8	0.26	1.58	1.83

10 Series MPR 15° Trajectory

Nozzle	Pressure psi	Radius Ft.	Flow gpm	Precip In/h	Precip In/h
10F 	15	7	1.16	2.28	2.63
	20	8	1.30	1.96	2.26
	25	9	1.44	1.71	1.98
	30	10	1.58	1.52	1.75
10H 	15	7	0.58	2.28	2.63
	20	8	0.65	1.96	2.26
	25	9	0.72	1.71	1.98
	30	10	0.79	1.52	1.75
10T 	15	7	0.39	2.28	2.63
	20	8	0.43	1.96	2.26
	25	9	0.48	1.71	1.98
	30	10	0.53	1.52	1.75
10Q 	15	7	0.29	2.28	2.63
	20	8	0.33	1.96	2.26
	25	9	0.36	1.71	1.98
	30	10	0.39	1.52	1.75







RAIN BIRD SPRAY NOZZLES

12 Series MPR 30° Trajectory





Nozzle	Pressure psi	Radius Ft.	Flow gpm	Precip In/h	Precip In/h
12F 	15	9	1.80	2.14	2.47
	20	10	2.10	2.02	2.34
	25	11	2.40	1.91	2.21
	30	12	2.60	1.74	2.01
12TQ 	15	9	1.35	2.14	2.47
	20	10	1.58	2.02	2.34
	25	11	1.80	1.91	2.21
	30	12	1.95	1.74	2.01
12TT 	15	9	1.20	2.14	2.47
	20	10	1.40	2.02	2.34
	25	11	1.60	1.91	2.21
	30	12	1.74	1.74	2.01
12H 	15	9	0.90	2.14	2.47
	20	10	1.05	2.02	2.34
	25	11	1.20	1.91	2.21
	30	12	1.30	1.74	2.01
12T 	15	9	0.60	2.14	2.47
	20	10	0.70	2.02	2.34
	25	11	0.80	1.91	2.21
	30	12	0.87	1.74	2.01
12Q 	15	9	0.45	2.14	2.47
	20	10	0.53	2.02	2.34
	25	11	0.60	1.91	2.21
	30	12	0.65	1.74	2.01

TECHNICAL INFORMATION

15 Series MPR 30° Trajectory

Nozzle	Pressure psi	Radius Ft.	Flow gpm	Precip In/h	Precip In/h
15F 	15	11	2.60	2.07	2.39
	20	12	3.00	2.01	2.32
	25	14	3.30	1.62	1.87
	30	15	3.70	1.58	1.83
15TQ 	15	11	1.95	2.07	2.39
	20	12	2.25	2.01	2.32
	25	14	2.48	1.62	1.87
	30	15	2.78	1.58	1.83
15TT 	15	11	1.74	2.07	2.39
	20	12	2.01	2.01	2.32
	25	14	2.21	1.62	1.87
	30	15	2.48	1.58	1.83
15H 	15	11	1.30	2.07	2.39
	20	12	1.50	2.01	2.32
	25	14	1.65	1.62	1.87
	30	15	1.85	1.58	1.83
15T 	15	11	0.87	2.07	2.39
	20	12	1.00	2.01	2.32
	25	14	1.10	1.62	1.87
	30	15	1.23	1.58	1.83
15Q 	15	11	0.65	2.07	2.39
	20	12	0.75	2.01	2.32
	25	14	0.82	1.62	1.87
	30	15	0.92	1.58	1.83

15 Series MPR 30° Trajectory

Nozzle	Pressure psi	W x L Ft.	Flow gpm
15SQ 	15	18 x 18	2.68
	20	19 x 19	3.06
	25	21 x 21	3.42
	30	23 x 23	3.73
15EST 	15	4 x 13	0.45
	20	4 x 14	0.50
	25	4 x 14	0.56
	30	4 x 15	0.61
15CST 	15	4 x 26	0.89
	20	4 x 28	1.00
	25	4 x 28	1.11
	30	4 x 30	1.21
15SST 	15	4 x 26	0.89
	20	4 x 28	1.00
	25	4 x 28	1.11
	30	4 x 30	1.21
9SST 	15	9 x 15	1.34
	20	9 x 16	1.47
	25	9 x 18	1.60
	30	9 x 18	1.73

MP Rotator Performance Data

		MP1000 Radius: 8' to 15' Adjustable Arc and Full Circle Color Code: Maroon, Lt. Blue, or Olive					MP2000 Radius: 13' to 21' Adjustable Arc and Full Circle Color Code: Black, Green, or Red					MP3000 Radius: 22' to 30' Adjustable Arc and Full Circle Color Code: Blue, Yellow, or Gray							
Arc	Pressure PSI	Color	Radius ft.	Flow GPM	Flow GPH	Precip in/hr ■ ▲	Color	Radius ft.	Flow GPM	Flow GPH	Precip in/hr ■ ▲	Color	Radius ft.	Flow GPM	Flow GPH	Precip in/hr ■ ▲			
	25	Maroon = 90° to 210°	-	-	-	-	Black = 90° to 210°	17'	0.31	18.6	0.41	0.48	Blue = 90° to 210°	25'	0.69	41.4	0.43	0.49	
	30		12'	0.16	9.6	0.43		0.50	18'	0.33	19.8	0.39		0.45	27'	0.74	44.4	0.39	0.45
	35		13'	0.18	10.8	0.40		0.46	19'	0.37	22.2	0.39		0.46	28'	0.80	48	0.39	0.45
	40		14'	0.19	11.4	0.39		0.45	20'	0.40	24	0.39		0.44	30'	0.86	51.6	0.37	0.43
	45		14'	0.20	12	0.39		0.45	21'	0.42	25.2	0.37		0.42	30'	0.91	54.6	0.39	0.45
	50		14'	0.21	12.6	0.38		0.43	21'	0.44	26.4	0.35		0.40	30'	0.96	57.6	0.41	0.47
	25	Maroon = 90° to 210°	-	-	-	-	Black = 90° to 210°	16'	0.58	34.8	0.44	0.50	Blue = 90° to 210°	25'	1.44	86.4	0.44	0.51	
	30		12'	0.32	19.2	0.43		0.50	17'	0.63	37.8	0.42		0.49	27'	1.58	94.8	0.42	0.48
	35		13'	0.35	21	0.40		0.46	18'	0.69	41.4	0.41		0.47	28'	1.70	102	0.42	0.48
	40		14'	0.37	22.2	0.39		0.45	19'	0.74	44.4	0.39		0.45	30'	1.82	109.2	0.39	0.45
	45		14'	0.40	24	0.39		0.45	20'	0.78	46.8	0.38		0.43	30'	1.93	115.8	0.41	0.48
	50		15'	0.41	24.6	0.38		0.43	21'	0.83	49.8	0.36		0.41	30'	2.04	122.4	0.44	0.50
	25	Lt. Blue = 210° to 270°	-	-	-	-	Green = 210° to 270°	16'	0.68	40.8	0.44	0.50	Yellow = 210° to 270°	25'	1.68	100.8	0.44	0.51	
	30		12'	0.37	22.2	0.43		0.50	17'	0.74	44.4	0.42		0.49	27'	1.84	110.4	0.42	0.48
	35		13'	0.41	24.6	0.40		0.46	18'	0.80	48	0.41		0.47	28'	1.99	119.4	0.42	0.48
	40		14'	0.43	25.8	0.39		0.45	19'	0.86	51.6	0.39		0.45	30'	2.12	127.2	0.39	0.45
	45		14'	0.46	27.6	0.39		0.45	20'	0.92	55.2	0.38		0.43	30'	2.25	135	0.41	0.48
	50		15'	0.48	28.8	0.38		0.43	21'	0.97	58.2	0.36		0.41	30'	2.37	142.2	0.43	0.50
	25	Lt. Blue = 210° to 270°	-	-	-	-	Green = 210° to 270°	16'	0.87	52.2	0.44	0.50	Yellow = 210° to 270°	25'	2.19	131.4	0.45	0.52	
	30		12'	0.48	29	0.43		0.50	17'	0.95	57	0.42		0.49	27'	2.37	142.2	0.42	0.48
	35		13'	0.54	32	0.40		0.46	18'	1.03	61.8	0.41		0.47	28'	2.55	153	0.42	0.48
	40		14'	0.57	34	0.39		0.45	19'	1.10	66	0.39		0.45	30'	2.73	163.8	0.39	0.45
	45		14'	0.60	36	0.39		0.45	20'	1.17	70.2	0.38		0.43	30'	2.89	173.4	0.41	0.48
	50		15'	0.63	38	0.38		0.43	21'	1.23	73.8	0.36		0.41	30'	3.06	183.6	0.44	0.50
	25	Olive = 360°	-	-	-	-	Red = 360°	16'	1.16	69.6	0.44	0.50	Grey = 360°	25'	2.88	172.8	0.44	0.51	
	30		12'	0.65	39	0.43		0.50	17'	1.27	76.2	0.42		0.49	27'	3.15	189	0.42	0.48
	35		13'	0.71	42.6	0.40		0.47	18'	1.37	82.2	0.41		0.47	28'	3.40	204	0.42	0.48
	40		14'	0.75	45	0.39		0.46	19'	1.47	88.2	0.39		0.45	30'	3.64	218.4	0.39	0.45
	45		14'	0.80	48	0.39		0.45	20'	1.56	93.6	0.38		0.43	30'	3.86	231.6	0.41	0.48
	50		15'	0.84	50.4	0.38		0.44	21'	1.64	98.4	0.36		0.41	30'	4.07	244.2	0.44	0.50
55	15'	0.87	52.2	0.37	0.43	21'	1.70	102	0.37	0.43	30'	4.27	256.2	0.46	0.53				



MP Rotator Performance Data

MPCorner
Radius: 8' to 15'
Adjustable Arc
Color Code: Turquoise

Arc	Pressure PSI	Color	Radius ft.	Flow GPM	Flow GPH
	25	Turquoise = 45° to 105°	-	-	-
	30		12'	0.17	10.2
	35		13'	0.18	10.8
	40		14'	0.19	11.4
	45		14'	0.21	12.6
	50		14'	0.22	13.2
	25	Turquoise = 45° to 105°	11'	0.31	18.6
	30		12'	0.34	20.4
	35		13'	0.36	21.6
	40		14'	0.39	23.4
	45		14'	0.41	24.6
	50		15'	0.43	25.8
	25	Turquoise = 45° to 105°	11'	0.36	21.6
	30		12'	0.39	23.4
	35		13'	0.42	25.2
	40		14'	0.45	27
	45		14'	0.48	28.8
	50		15'	0.51	30.6
55	15'	0.53	31.8		

MP Rotator Performance Data

MPLCS515
MPRCS515
MPSS530

Nozzle Model	Pressure PSI	Color	Width x Length	Flow GPM	Flow GPH
	30	Ivory	4' x 14'	0.19	11.4
	35		5' x 15'	0.21	12.6
	40		5' x 15'	0.22	13.2
	45		5' x 15'	0.23	13.8
	50		6' x 16'	0.25	15
	55		6' x 16'	0.26	15.6
	30	Copper	4' x 14'	0.19	11.4
	35		5' x 15'	0.21	12.6
	40		5' x 15'	0.22	13.2
	45		5' x 15'	0.23	13.8
	50		6' x 16'	0.25	15
	55		6' x 16'	0.26	15.6
	30	Brown	4' x 28'	0.38	22.8
	35		5' x 30'	0.41	24.6
	40		5' x 30'	0.44	26.4
	45		5' x 30'	0.47	28.2
	50		6' x 32'	0.49	29.4
	55		6' x 32'	0.51	30.6

TECHNICAL INFORMATION

ROTOR NOZZLES RAIN BIRD - 3500 Series

Pressure psi	Nozzle	Radius Ft.	Flow GPM	Precip In/h	Precip In/h
25	0.75	15	0.54	0.46	0.53
	1.0	20	0.77	0.37	0.43
	1.5	23	1.06	0.39	0.45
	2	27	1.40	0.37	0.43
	3	29	2.17	.050	0.57
	4	31	2.97	0.59	0.69
35	0.75	17	0.67	0.45	0.52
	1.0	21	0.92	0.40	0.46
	1.5	23	1.28	0.47	0.54
	2	27	1.69	0.45	0.52
	3	31	2.60	0.52	0.60
	4	33	3.58	0.63	0.73
45	0.75	17	0.77	0.51	0.59
	1.0	21	1.06	0.46	0.53
	1.5	24	1.48	0.49	0.57
	2	27	1.93	0.51	0.59
	3	31	3.00	0.60	0.69
	4	35	4.13	0.65	0.75
55	0.75	18	0.85	0.51	0.58
	1.0	22	1.18	0.47	0.54
	1.5	24	1.65	0.55	0.64
	2	28	2.15	0.53	0.61
	3	32	3.25	0.61	0.71
	4	35	4.60	0.72	0.83

Precipitation Rates based on half-circle operation.

■ Square spacing based on 50% diameter of throw.

▲ Triangular spacing based on 50% diameter of throw.

Performance data collected in zero wind conditions.

TECHNICAL INFORMATION

ROTOR NOZZLES

RAIN BIRD - 5000 Series

Standard Rain Curtain Nozzle



Pressure psi	Nozzle	Radius Ft.	Flow GPM	Precip In/h	Precip In/h
25	1.0	27	0.80	0.21	0.24
	1.5	31	1.00	0.20	0.23
	2.0	31	1.65	0.33	0.38
	3.0	35	2.58	0.41	0.47
	4.0	35	3.20	0.50	0.58
	6.0	35	4.46	0.70	0.81
35	1.0	28	0.97	0.24	0.28
	1.5	31	1.25	0.25	0.29
	2.0	32	1.99	0.37	0.43
	3.0	37	3.11	0.44	0.51
	4.0	37	3.86	0.54	0.63
	6.0	37	5.42	0.76	0.88
45	1.0	28	1.12	0.28	0.32
	1.5	32	1.42	0.27	0.31
	2.0	32	2.31	0.43	0.50
	3.0	37	3.59	0.51	0.58
	4.0	37	4.46	0.63	0.72
	6.0	37	6.26	0.88	1.02
55	1.0	28	1.23	0.30	0.35
	1.5	31	1.60	0.32	0.37
	2.0	33	2.56	0.45	0.52
	3.0	37	3.95	0.56	0.64
	4.0	38	4.96	0.66	0.76
	6.0	40	7.03	0.85	0.98
65	1.0	28	1.35	0.33	0.38
	1.5	31	1.77	0.35	0.41
	2.0	33	2.89	0.51	0.59
	3.0	38	4.37	0.58	0.67
	4.0	38	5.40	0.72	0.83
	6.0	40	7.65	0.92	1.06

Low Angle Nozzle



Pressure psi	Nozzle	Radius Ft.	Flow GPM	Precip In/h	Precip In/h
25	1.0	23	0.69	0.25	0.29
	2.0	24	1.45	0.48	0.56
	4.0	25	3.14	0.97	1.12
35	1.0	25	0.80	0.25	0.29
	2.0	26	1.77	0.50	0.58
	4.0	28	3.84	0.94	1.09
45	1.0	26	0.94	0.27	0.31
	2.0	27	2.04	0.54	0.62
	4.0	31	4.29	0.86	0.99
55	1.0	26	1.04	0.30	0.34
	2.0	28	2.27	0.56	0.64
	4.0	31	4.74	0.95	1.10
65	1.0	26	1.15	0.33	0.38
	2.0	29	2.45	0.56	0.65
	4.0	31	5.21	1.04	1.21

Precipitation Rates based on half-circle operation.

■ Square spacing based on 50% diameter of throw.

▲ Triangular spacing based on 50% diameter of throw.

Performance data collected in zero wind conditions.

TECHNICAL INFORMATION

ROTOR NOZZLES

HUNTER PGP

Standard Nozzles (Blue)

Nozzle	Pressure PSI	Radius Ft.	Flow GPM
1.5	25	29	1.2
	35	31	1.4
	45	31	1.5
	55	32	1.8
	65	32	1.9
2.0	25	33	1.4
	35	33	1.7
	45	34	2.0
	55	34	2.1
	65	32	2.3
2.5	25	33	1.7
	35	35	2.1
	45	35	2.5
	55	35	2.6
	65	35	2.9
3.0	25	35	2.2
	35	36	2.7
	45	38	3.0
	55	39	3.4
	65	39	3.7

Standard Nozzles (Blue)

Nozzle	Pressure PSI	Radius Ft.	Flow GPM
4.0	25	37	3.0
	35	39	3.5
	45	40	4.0
	55	41	4.5
	65	41	4.8
5.0	25	37	3.7
	35	39	4.5
	45	42	5.0
	55	42	5.7
	65	42	6.2
6.0	25	38	4.3
	35	40	5.6
	45	43	6.0
	55	44	6.7
	65	44	7.3
8.0	25	37	6.0
	35	41	7.0
	45	44	8.0
	55	46	9.0
	65	46	9.8

Data represents test results in zero wind. Adjust for local conditions. Radius may be reduced up to 25% with adjustment screw (this may alter the uniformity of the pattern).

Optimum performance is shown in bold type.

TECHNICAL INFORMATION

ROTOR NOZZLES

HUNTER I-20

Standard Nozzles

Nozzle	Pressure PSI	Radius Ft.	Flow GPM
1.0	30	30'	.9
	40	31'	1.0
	50	31'	1.2
	60	32'	1.3
1.5	30	32'	1.2
	40	33'	1.4
	50	34'	1.6
	60	34'	1.8
2.0	30	34'	1.6
	40	36'	1.8
	50	38'	2.0
	60	38'	2.2
3.0	30	36'	2.0
	40	38'	2.4
	50	40'	2.7
	60	40'	2.9

Standard Nozzles

Nozzle	Pressure PSI	Radius Ft.	Flow GPM
3.5	30	36'	2.6
	40	40'	3.0
	50	42'	3.4
	60	42'	3.7
4.0	30	37'	3.2
	40	40'	3.7
	50	43'	4.2
	60	44'	4.6
6.0	30	35'	4.2
	40	40'	4.9
	50	43'	5.5
	60	44'	6.0
8.0	30	41'	6.0
	40	44'	6.8
	50	45'	7.6
	60	47'	8.2

Data represents test results in zero wind. Adjust for local conditions. Radius may be reduced up to 25% with adjustment screw (this may alter the uniformity of the pattern).

Optimum performance is shown in bold type.

Landscape Lighting Technical Data

Voltage Drop Formula

$$\frac{\text{Total Watts on Cable} \times \text{Length of Run in Feet}}{\text{Cable Size Constant (see Chart at right)}} = \text{Voltage Drop}$$

LED Fixtures designed to work within a 9volt - 15volt range. This broad range of voltage, along with lower power consumption in watts, basically eliminates the need to calculate voltage drop!!!

Effect of Voltage on Lamp/Life Output

Voltage at Lamp	Life Expectancy of Lamp	% of Rated Candlepower
13.2	2/3 rated life	350
12.6	3/4 rated life	180
12.0	AS RATED	100
11.5	2 x rated	80
11.0	3 x rated	75
10.75	4 x rated	70*
10.5	5 x rated	65
10.0	9 x rated	50

* Lowest recommended Candlepower output.

Cable Size Constants

#18	1380
#16	2200
#14	3500
#12	7500
#10	11920
#8	18960
#6	30150

Design Options

Straight Run Installation

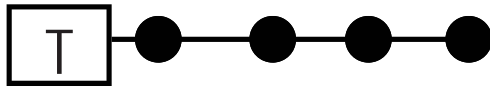

Loop Installation

Helps reduce voltage drop.

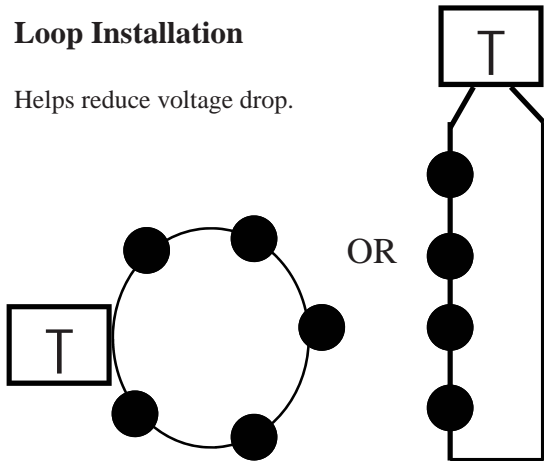

Split Load Installation

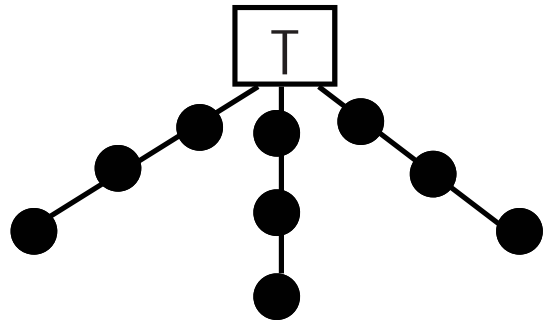

"T" Installation

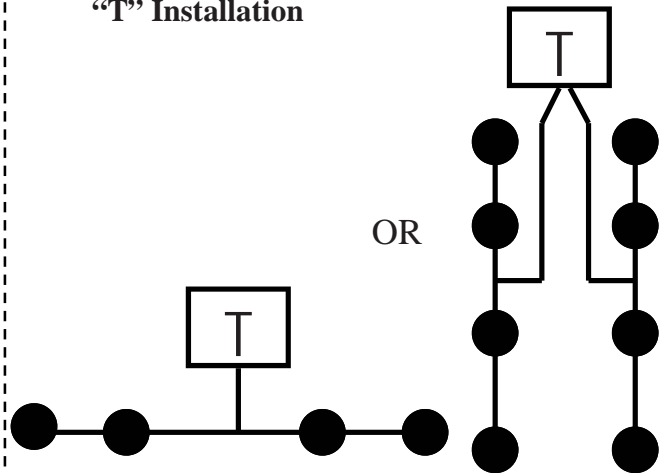

Water Feature Pump Sizing Charts



Tsurumi PL (Flow in GPH) Ideal for LOW to MEDIUM head applications

3-PL #29975	3000	1800	
5-PL #29976	5000	4100	3150 1800
9-PL #29977	6800	6200	5400 4700 3700 3000



Tsurumi PN (Flow in GPH) Ideal for MEDIUM to HIGH head applications

3-PN #29493	3630	2760	2400	1800	1080	
4-PN #29494	4740	4320	3700	3000	2400	1800 1080 600
8-PN #29495	5520	5400	5340	4800	4200	3600 3000 1800 1200 600



AquaSurge (Flow in GPH) Ideal for LOW head applications

AS2000 #98125	1500	1300	900	300
AS3000 #99546	2853	1902		
AS4000 #99547	3300	2700	1426	
AS5000 #99548	4280	3328	2377	
AS7000 #98484	5100	4000	2800	



AquaScapePRO™ (Flow in GPH) Ideal for MEDIUM to HIGH head applications

3000 #20002	2900	2000	1200
4500 #20003	4500	4000	3300 2700 2000 1000
7500 #20004	6700	6100	5300 4900 4000 3200 2200 1100
10,000 #20006	10600	8100	6900 4900 2300



Goulds (Flow in GPH) Ideal for LOW to MEDIUM head applications

10,000 #29792	9600	7200	5400	3000	300
---------------	------	------	------	------	-----

Best Zone for Energy Efficiency and Pump Life Expectancy
 Maximum Suggested Operating Zone
 Do Not Operate Zone - Choose better suited pump or utilize a ball valve to create artificial head pressure

	@1'	@5'	@10'	@15'	@20'	@25'	@30'
TW1200 (gph)	1290	1080	720	180	0@16'		
(gpm)	22	18	12	3			
TW1900 (gph)	1900	1440	900	360	0@18'		
(gpm)	32	24	15	6			
TW2400 (gph)	2400	1950	1390	825	220	0@22'	
(gpm)	40	32	23	14	4		
TW3700 (gph)	3730	3010	2230	1425	660	0@24'	
(gpm)	62	50	37	24	11		
TW4800 (gph)	4800	4000	3140	2228	1260	240	0@27'
(gpm)	80	67	52	37	21		
TW6000 (gph)	6000	5040	4050	3000	1930	852	0@29'
(gpm)	100	84	68	50	32	14	

Recommended Operating Range

	@5'	@7.5'	@10'	@12.5'	@15'	@17.5'	@20'	@22.5'	@25'	@30'	@35'
PAF-20 (gph)	2800	2380	1950	1520	1080	640	180				
(gpm)	47	40	33	25	18	11	3				
PAF-25 (gph)	3900	3540	3150	2750	2300	1850	1350	820	240		
(gpm)	65	59	53	46	38	31	23	14	4		
PAF-40 (gph)	4950	4680	4350	3970	3570	3150	2700	2220	1700	520	
(gpm)	83	78	73	66	60	53	45	37	28	9	
PAF-75 (gph)	5950	5600	5270	4930	4560	4170	3750	3310	2830	1770	550
(gpm)	99	93	88	82	76	70	63	55	47	30	9

*Operating pumps outside of the recommended range may cause bearing damage and premature failure.

Best Efficiency Point Recommended Operating Range

	@5'	@10'	@15'	@20'	@25'	@30'	@35'	@40'	@45'	@50'	@60'
A-05 (gph)	3165	2838	2500	2154	1875	1452	933	318	0@42'		
(gpm)	53	47	42	36	31	24	16	5			
A-21 (gph)	5811	5325	4824	4335	3771	3141	2400	1530	540	0@47'	
(gpm)	97	89	80	72	63	52	40	26	9		
A-31 (gph)	9300	8148	6828	5535	4119	2535	625	0@37'			
(gpm)	155	136	114	92	68	42	13				
A-315 (gph)	12000	11040	10440	9780	9000	8280	7560	6780	5580	4920	2280
(gpm)	200	184	174	163	150	138	126	113	98	82	38

*Operating pumps outside of the recommended range may cause bearing damage and premature failure.

Best Efficiency Point Recommended Operating Range



Corporate Headquarters
 6001 S. 57th St.
 Lincoln, NE 68516
 800-798-2473 Fax: 402-423-5326

CREDIT APPLICATION

APPLICANT BUSINESS NAME _____

BILLING ADDRESS _____
PO BOX OR STREET CITY COUNTY STATE ZIP/+4

PHYSICAL ADDRESS _____
STREET CITY COUNTY STATE ZIP/+4

BUSINESS PHONE (____) _____ FAX (____) _____

E-MAIL ADDRESS _____ CELLULAR (____) _____

WEBSITE ADDRESS _____ FEDERAL TAX ID # _____

SOLE PROPRIETOR PARTNERSHIP CORPORTATION L.L.C. OTHER

OFFICERS/OWNERS

Principal/Owner/Title _____ Address _____
PO Box or Street City State Zip

Principal/Owner/Title _____ Address _____
PO Box or Street City State Zip

Principal/Owner/Title _____ Address _____
PO Box or Street City State Zip

TRADE REFERENCES

Name	Phone Number	Fax Number
1. _____	_____	_____
2. _____	_____	_____
3. _____	_____	_____

BANK REFERENCES

Bank Name _____ Phone _____ Contact _____

Acct # _____ Acct Name _____ Bank Contact _____

SALES INFORMATION

BILLING INFORMATION

Member of Manufacturer Point Program: Aquascape Hunter Irritrol Kichler Rain Bird

REAMS Branch frequented most _____ Sales Tax to be charged **Y** **N**

Type of Business _____ Sales Tax Exempt # _____
Please attach applicable resale or exempt certificate

Number of Years in Business _____ Purchase Order Required **Y** **N**

Estimated Annual Purchases \$ _____ A/P Contact _____

REAMS was recommended by _____ Monthly Statement Requested **Y** **N**

Invoices and/or statements will be sent by fax or email Preferred method of delivery **Fax** **E-mail**

A/P Fax _____ A/P Email _____

FOR YOUR CONVENIENCE THIS DOCUMENT MAY BE FAXED TO INITIATE PROCESSING TO 402-423-5326. HOWEVER, THE ORIGINAL, INCLUDING SIGNATURES, IS REQUIRED TO CONSIDER OPENING THE ACCOUNT.

TERMS OF SALE

- 1. **Acceptance.** Seller reserves the right to accept or reject any orders and shall not be required to give any reason for non-acceptance. Purchaser shall be obligated to pay the purchase price reflected on the invoice in accordance with the terms hereof.
- 2. **Taxes.** All specified prices are exclusive of all present or future sales, revenue or excise tax or other governmental charge upon the production, sale or shipment of products imposed by federal, state, municipal or other authorities. Whenever applicable such tax or taxes shall be added to the invoice as a separate charge to be paid by the purchaser, or in lieu thereof the purchaser shall provide the seller with a tax exemption certificate acceptable to the taxing authorities. Sales, use, occupational, excise, or other similar taxes are not included in prices quoted by REAMS.
- 3. **Terms of Payment.** Past due accounts are subject to 1 – 1/2% service charge per month (18% annual percentage rate) and will be put on hold after 30 days. Payment is due as stated on the invoice.
- 4. **Delivery.** All prices are F.O.B. place of seller's business or shipment. Method and route of shipment are at seller's discretion, unless purchaser provides explicit instructions. Title to specified products shall remain with seller until paid in full by purchaser. However, risk of loss shall rest in the purchaser at the time of delivery of the products to the carrier at seller's place of business. Seller's responsibility for shipment ceases upon delivery to a transportation company and any claims for shortages, delays or damages occurring thereafter shall be made by Purchase directly to the transportation company. Any claims which purchase may be entitled to make against seller for shortages and shipments shall be made within fifteen (15) days after receipt of shipment. Seller shall not be liable for any delays due to causes beyond seller's control.
- 6. **Disclaimer of Warranty.** THE SELLER EXPRESSLY DISCLAIMS ALL REPRESENTATIONS AND WARRANTIES WHETHER EXPRESS OR IMPLIED REGARDING ANY NEW OR USED ITEM OR PRODUCT ORDERED HEREUNDER, INCLUDING WITHOUT LIMITATION ANY IMPLIED WARRANTY OF MERCHANTABILITY OR FITNESS FOR A PARTICULAR PURPOSE. Purchaser's sole and exclusive remedy, if any, or defects in materials or workmanship with respect to any new or used item or product shall be against the manufacturer or manufacturers thereof pursuant to the express written warranty, if any extended by such manufacturer or manufacturers with respect to such item or product. In no event shall seller be liable for any incidental special or consequential damage for any cause whatsoever, or injury to persons or property or any other consequential economic or special incidental loss arising from the use of any item or product. No waiver, alteration or modification of the foregoing shall be valid unless made in writing and signed by an officer of the seller.
- 7. **Returns.** No returns of products will be accepted without prior written approval of seller. Returns are subject to a charge of 15% of the original purchase price for handling plus all transportation charges and must be accompanied by product invoice. Credit will be based upon the quantity received in resalable condition and as determined by seller.
- 8. **Cancellation.** An order once placed with and accepted by seller can be cancelled only with our consent and upon terms that will indemnify seller against loss.
- 9. **Purchase Order.** If a quotation is accepted and the purchaser's order form is used for this purpose, it is expressly understood and agreed that the terms and conditions herein set forth shall prevail insofar as the same may in anyway conflict with the terms and conditions herein set forth shall prevail insofar as the same may in anyway conflict with the terms and conditions set forth in such order form, and the issuance of such order by the purchaser shall be deemed to note the purchaser's assent to the foregoing.
- 10. **Indemnity.** Purchaser further agrees to indemnify and save harmless seller from all loss, damage, expense and penalty arising from any action on account of any injury to person or property of any character whatsoever occasioned by the operation, handling or transportation of any of the products sold hereunder and while the product(s) are in the possession or under the custody and control of purchaser.
- 11. **Collection.** In the event any action either to collect payment or enforce the terms and provisions of the agreement becomes necessary, purchaser agrees to pay reasonable attorney's fees to seller should this matter be placed in the hands of an attorney for collection.
- 12. **Release.** The Purchaser certifies the information provided to the Seller on the application is true and correct and is made for the purpose of determining its eligibility for credit. Purchaser authorizes Seller to obtain credit and financial information concerning the Purchase (both as a company and personally) at any time and from any source. This includes but is not limited to, the procurement of consumer credit reports from any consumer reporting agency, obtaining credit information from banks, financial institutions, trade references, merchants, landlords or other creditors, whether or not so identified in Purchaser's application for credit. Purchaser agrees to execute any appropriate request, release, authorization, application or other document necessary for Seller to obtain such credit information.

Applicant acknowledges having kept a copy of this credit application for their business records.

APPLICANT'S NAME	SIGNATURE	TITLE	DATE

PERSONAL GUARANTEE

In order to induce REAMS to extend credit to the undersigned (hereafter referred to as the "Guarantor"), and all related companies, assigns and successors, I unconditionally personally guarantee the debt due to REAMS and understand that the extension of credit by REAMS is based upon its personal guarantee. I agree to bind myself to pay REAMS on demand any sums which may become due to REAMS on this account whenever the applicant company shall fail to pay the same, together with costs and expenses (including reasonable attorney's fees) incurred by REAMS in the collections of the account. This guarantee shall continue in existence until properly revoked in writing, shall be effective despite renewal, modification or waiver by REAMS of any of the applicant company's obligations hereunder, and no such modification renewal or waiver shall be operate to defeat this guarantee.

I/We hereby authorize release to REAMS of all information, including credit information, contained in our account file. I/We authorize that the photocopy of the authorization be accepted with the same authority as the original

Signatures

signature (owner)	signature (owner)
print	print
Social Security # _____	Social Security # _____
signature (spouse)	signature (spouse)
print	print
home address	home address
city , state, zip	city, state, zip
home address	home address
city , state, zip	city, state, zip

Locations



LINCOLN*

6001 S. 57th Street
Lincoln, NE 68516
402-423-0120
800-798-2473
Fax: 402-423-5326

***Corporate Headquarters**

OMAHA

3625 S. 149th Street
Omaha, NE 68144
402-896-1600
877-838-1600
Fax: 402-896-4425

GRAND ISLAND

453 Industrial Lane
Grand Island, NE 68803
308-381-6000
888-381-6677
Fax: 308-381-8682

SIOUX CITY

1915 Floyd Blvd.
Sioux City, IA 51104
712-258-7326
800-373-2009
Fax: 712-258-8225

CEDAR RAPIDS - Marion

3780 4th Ave., Suite D
Marion, IA 52302
319-377-2203
800-779-5864
Fax: 319-377-2904

DES MOINES - Urbandale

10052 Justin Dr. Suite J
Urbandale, IA 50322
515-270-8844
800-373-2907
Fax: 515-270-8864

KANSAS CITY - Lenexa

14303 W. 100th St.
Lenexa, KS 66215
913-599-5407
800-727-4867
Fax: 913-599-3919

SPRINGFIELD - Nixa

1210 N. Eagle Crest
Nixa, MO 65714
417-725-5490
800-366-5066
Fax: 417-725-6836

www.reams.net