



Air Conditioning & Heating

AVPTC

MULTI-POSITION, INTERNAL TXV VARIABLE-SPEED ECM BASED COMFORTNET™ COMPATIBLE AIR HANDLER

1½ TO 5 TONS



Product Features

- Internal factory-installed thermal expansion valves for cooling and heat pump applications
- Variable-speed ECM blower motor
- ComfortNet™ Communicating System compatible
- Auto configuration of the airflow and tonnage in communicating mode
- Provides constant CFM over a wide range of static pressure conditions independent of duct system
- CFM indicator
- Fault recall of six most recent faults
- Provides adjustable low CFM for efficient fan-only operation
- Improved humidity and comfort control
- Built-in compatibility with multi-stage heat pump and cooling applications
- All-aluminum evaporator coil
- Cabinet air leakage less than 2.0% at 1.0 inch H2O when tested in accordance with ASHRAE standard 193
- Cabinet air leakage less than 1.4% at 0.5 inch H2O when tested in accordance with ASHRAE standard 193
- 3 kW – 25 kW electric heater kits
- Horizontal or vertical configuration capabilities
- Rigid SmartFrame™ cabinet
- 21" depth for easier attic access
- DecaBDE-free thermoplastic drain pan with secondary drain connections
- Screw-less sides and back helps to reduce condensation when installed in humid locations
- Foil-faced insulation covers the internal casing to reduce cabinet condensation
- Galvanized, leather grain-embossed finish
- Glue-less cabinet insulation retention
- Tool-less filter access
- AHRI certified; ETL listed

Contents

Air Handler Nomenclature	2
Heater Kit Nomenclature	2
Product Specifications	3
Dimensions	4
Airflow Data	5
Heat Kit Data	7
Wiring Diagram.....	9
Accessories	12



* Complete warranty details available from your local dealer or at www.goodmanmfg.com. To receive the 10-Year Parts Limited Warranty, online registration must be completed within 60 days of installation. Online registration is not required in California or Quebec.

NOMENCLATURE

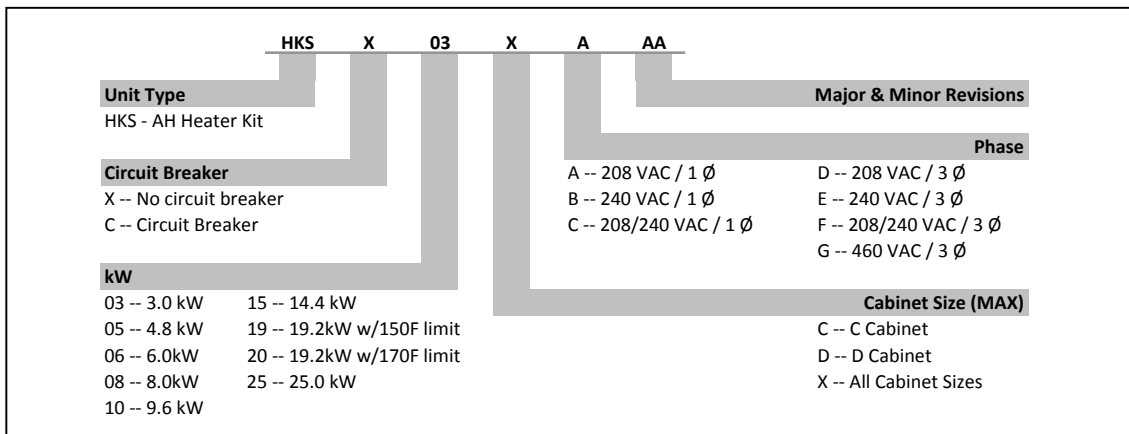
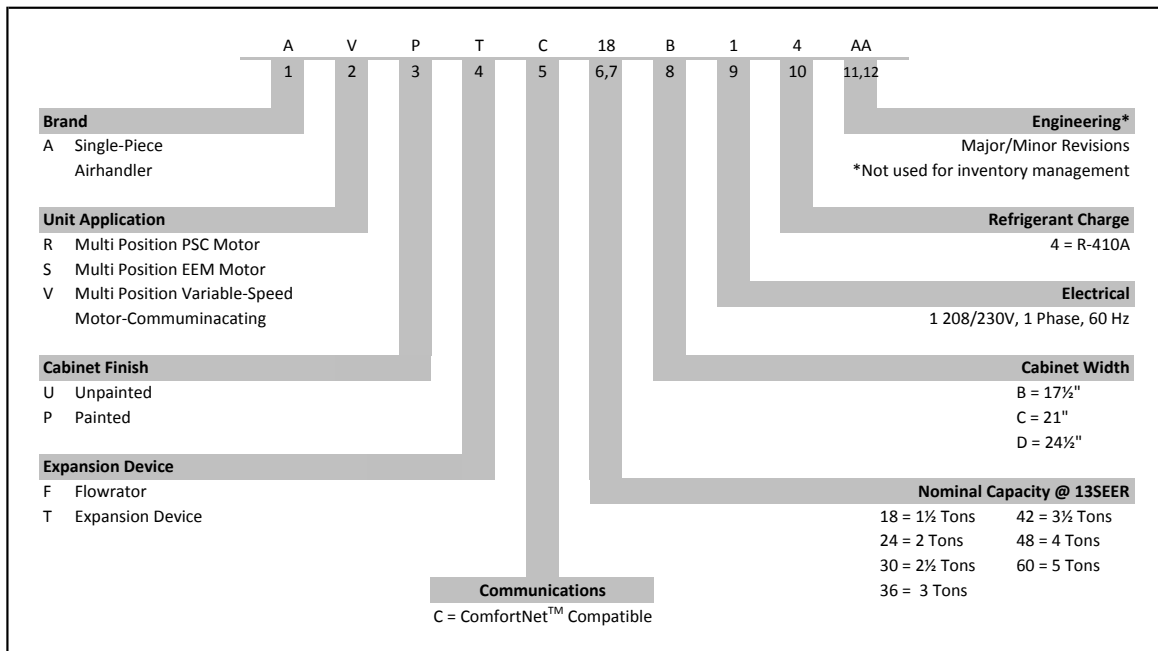

HEATING kW CORRECTION FACTOR

SUPPLY VOLTAGE	240	230	220	210	208
CORRECTION FACTOR	1.00	0.92	0.84	0.77	0.75

Multiply the 240-volt heating capacity by correction factors.

SPECIFICATIONS

	AVPTC 24B14A*	AVPTC 30C14A*	AVPTC 36C14A*	AVPTC 42C14A*	AVPTC 48C14A*	AVPTC 48D14A*	AVPTC 60D14A*
NOMINAL RATINGS							
Cooling (BTU/h)	24,000	30,000	36,000	42,000	48,000	48,000	60,000
BLOWER							
Diameter	10 $\frac{5}{8}$ "	10 $\frac{5}{8}$ "	10 $\frac{5}{8}$ "	10 $\frac{5}{8}$ "	10 $\frac{5}{8}$ "	10 $\frac{5}{8}$ "	11 $\frac{1}{8}$ "
Width	6"	8"	10 $\frac{5}{8}$ "	10 $\frac{5}{8}$ "	10 $\frac{5}{8}$ "	10 $\frac{5}{8}$ "	10 $\frac{5}{8}$ "
COIL CONNECTIONS							
Liquid	$\frac{3}{8}$ "	$\frac{3}{8}$ "	$\frac{3}{8}$ "	$\frac{3}{8}$ "	$\frac{3}{8}$ "	$\frac{3}{8}$ "	$\frac{3}{8}$ "
Suction	$\frac{3}{4}$ "	$\frac{7}{8}$ "	$\frac{7}{8}$ "	$\frac{7}{8}$ "	$\frac{7}{8}$ "	$\frac{7}{8}$ "	$\frac{7}{8}$ "
Coil Drain Connection (FPT)	$\frac{3}{4}$ "	$\frac{3}{4}$ "	$\frac{3}{4}$ "	$\frac{3}{4}$ "	$\frac{3}{4}$ "	$\frac{3}{4}$ "	$\frac{3}{4}$ "
ELECTRICAL DATA							
Voltage	208/230	208/230	208/230	208/240	208/230	208/230	208/230
Min Circuit Ampacity	4.9/4.9	4.9/4.9	6.5/6.5	6.5/6.5	6.5/6.5	6.5/6.5	8.6/8.6
Max. Overcurrent Device (Amps)	15/15	15/15	15/15	15/15	15/15	15/15	15/15
Minimum VAC	197	197	197	197	197	197	197
Maximum VAC	253	253	253	253	253	253	253
BLOWER MOTOR							
Full Load Amps (FLA)	3.9	3.9	5.2	5.2	5.2	5.2	6.9
Horsepower (HP)	$\frac{1}{2}$	$\frac{1}{2}$	$\frac{3}{4}$	$\frac{3}{4}$	$\frac{3}{4}$	$\frac{3}{4}$	1
SHIP WEIGHT (LBS.)							
	100	118	118	155	125	167	167

NOTE: Minimum Circuit Ampacity (MCA) and Maximum Overcurrent Protection (MOP) for blower without supplemental heat installed.
Refer to unit nameplate and/or Heat Kit Data for specification with approved accessory heaters installed

DIMENSIONS

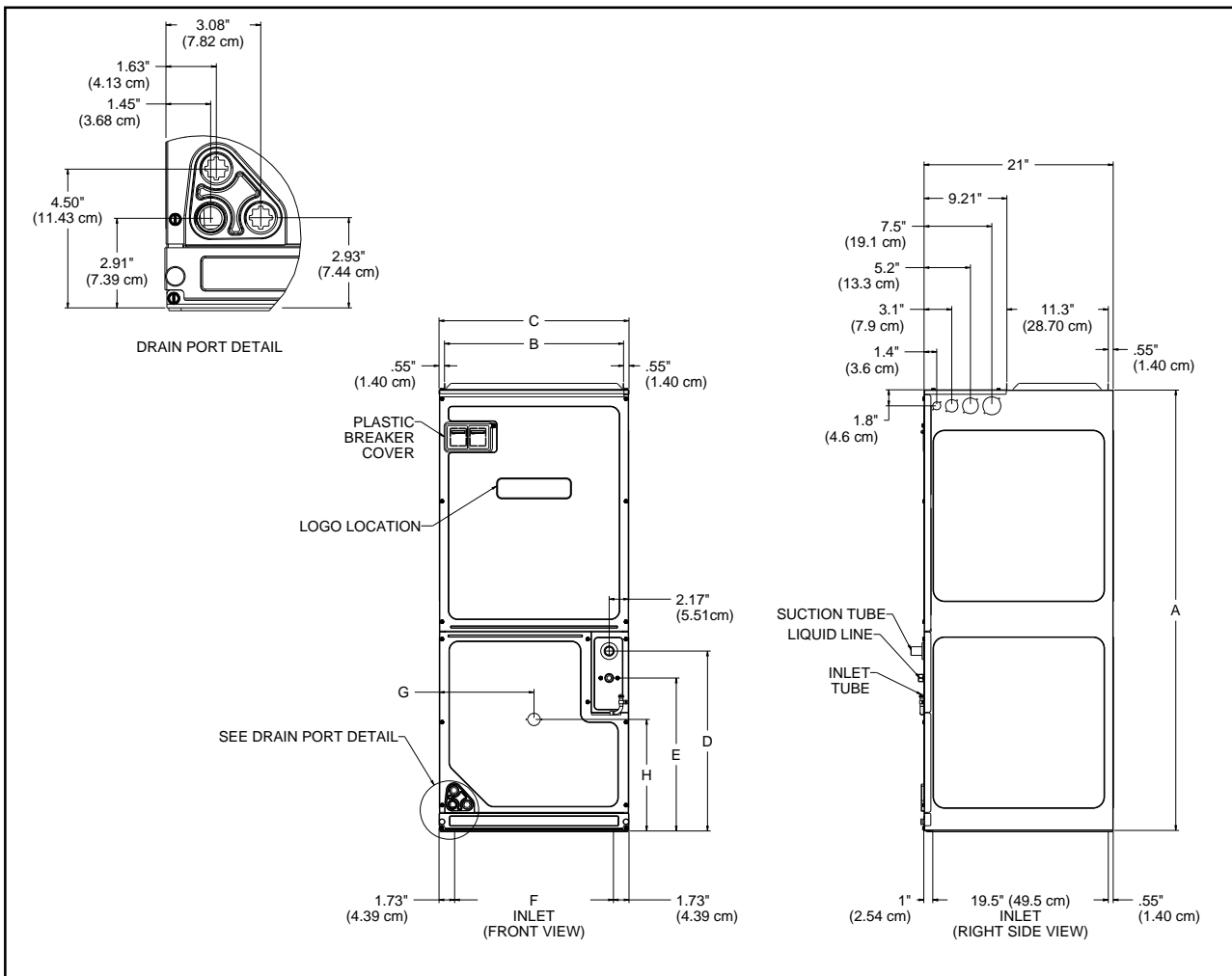

MODEL	A	B	C	D	E	F	G	H
AVPTC24B14A*	45	16%	17½	18	15	14¼	8%	12
AVPTC30C14A*	49	20	21	20	17	17¾	10½	12¾
AVPTC36C14A*	49	20	21	20	17	17¾	10½	12¾
AVPTC42D14A*	58	23%	24½	28¼	25¼	21¼	12¾	12%
AVPTC48C14A*	49	20	21	20	17	17¾	10½	12¾
AVPTC48D14A*	58	23%	24½	28¼	25¼	21¼	12¾	12%
AVPTC60D14A*	58	23%	24½	28¼	25¼	21¼	12¾	12%

AIRFLOW DATA

COOLING / HEAT PUMP AIRFLOW

AVPTC24B

		0.1	0.2	0.3	0.4	0.5	0.6	0.7	0.8	0.9
A	Low	415	415	410	410	405	405	400	400	400
B	Low	575	570	565	560	560	555	555	550	550
C	Low	685	670	660	650	645	635	630	625	620
D	Low	795	780	765	755	745	735	725	720	715
A	High	620	615	610	605	600	600	595	590	590
B	High	865	850	835	825	815	805	795	790	785
C	High	1005	990	970	960	945	935	920	915	910
D	High	1165	1145	1125	1110	1100	1085	1070	1065	1055

AVPTC30C

		0.1	0.2	0.3	0.4	0.5	0.6	0.7	0.8	0.9
A	Low	465	455	440	430	425	415	405	400	395
B	Low	615	610	605	600	595	595	590	585	585
C	Low	755	745	740	735	730	725	720	720	715
D	Low	900	890	885	880	875	870	865	865	860
A	High	620	615	610	610	605	605	600	600	600
B	High	850	840	835	830	825	820	815	815	810
C	High	1030	1025	1020	1015	1010	1010	1005	1000	1000
D	High	1245	1235	1225	1220	1210	1205	1200	1195	1195

AVPTC36C

		0.1	0.2	0.3	0.4	0.5	0.6	0.7	0.8	0.9
A	Low	515	505	500	485	465	460	450	425	410
B	Low	715	705	700	685	675	670	660	640	630
C	Low	950	935	930	910	895	890	875	855	835
D	Low	1135	1125	1120	1105	1090	1085	1075	1055	1040
A	High	740	730	725	710	695	690	680	660	645
B	High	1015	1005	1000	985	965	960	950	925	910
C	High	1345	1335	1330	1315	1300	1295	1290	1270	1255
D	High	1615	1605	1600	1585	1570	1565	1555	1535	1520

AVPTC42D

		0.1	0.2	0.3	0.4	0.5	0.6	0.7	0.8	0.9
A	Low	600	580	560	545	535	520	505	500	490
B	Low	795	780	765	750	740	730	720	715	710
C	Low	1025	1010	995	985	970	960	950	945	940
D	Low	1250	1235	1225	1215	1210	1200	1195	1190	1185
A	High	835	815	800	790	780	765	755	750	745
B	High	1115	1105	1090	1080	1070	1065	1055	1050	1045
C	High	1445	1430	1420	1410	1405	1395	1390	1385	1380
D	High	1775	1760	1750	1740	1735	1725	1720	1715	1710

AVPTC48C

		0.1	0.2	0.3	0.4	0.5	0.6	0.7	0.8	0.9
A	Low	510	505	500	490	485	480	475	465	455
B	Low	710	705	700	690	680	680	670	660	650
C	Low	940	935	930	920	910	910	905	890	880
D	Low	1165	1160	1160	1155	1150	1145	1140	1135	1125
A	High	735	730	725	715	705	700	695	685	675
B	High	1010	1005	1000	990	985	980	975	965	955
C	High	1340	1335	1330	1320	1310	1310	1305	1290	1280
D	High	1675	1665	1660	1645	1635	1630	1620	1605	1590

AIRFLOW DATA (CONT.)

COOLING / HEAT PUMP AIRFLOW (CONT.)

AVPTC48D

		0.1	0.2	0.3	0.4	0.5	0.6	0.7	0.8	0.9
A	Low	910	910	900	895	885	880	875	870	850
B	Low	1050	1045	1035	1030	1025	1020	1015	1010	1010
C	Low	1155	1145	1140	1135	1130	1125	1120	1120	1115
D	Low	1215	1210	1200	1195	1190	1185	1180	1175	1170
A	High	1370	1360	1350	1345	1340	1330	1325	1325	1320
B	High	1570	1560	1550	1545	1535	1530	1525	1520	1515
C	High	1720	1710	1700	1695	1685	1680	1670	1670	1665
D	High	1840	1820	1800	1785	1775	1760	1745	1740	1735

AVPTC60D

		0.1	0.2	0.3	0.4	0.5	0.6	0.7	0.8	0.9
A	Low	1205	1205	1210	1205	1205	1200	1195	1195	1195
B	Low	1375	1370	1365	1360	1360	1355	1355	1350	1350
C	Low	1445	1445	1450	1445	1445	1440	1440	1440	1435
D	Low	1535	1530	1525	1520	1520	1515	1510	1510	1510
A	High	1615	1615	1610	1610	1605	1605	1600	1600	1600
B	High	1825	1820	1815	1810	1810	1805	1805	1805	1800
C	High	1930	1925	1920	1915	1915	1910	1905	1905	1900
D	High	2040	2030	2025	2020	2015	2010	2005	2005	2000

Note:

- The chart is for information only. For satisfactory operation, external static pressure must not exceed value shown on rating plate.
- Use the CFM adjustment factors of .98 for horizontal left, .95 for horizontal right & .96 for downflow orientations.
- Airflow data indicated is at 230V without air filter in place.

ELECTRIC HEAT AIRFLOW

HTR kW	9	10	11	AVPTC 24B14A*	AVPTC 30C14A*	AVPTC 36C14A*	AVPTC 42D14A†	AVPTC 48C14A*	AVPTC 48D14A††	AVPTC 60D14A†††
3	ON	ON	ON	730	730	NR	850**	NR	NR	NR
5	ON	ON	OFF	780	780	850	1250	850	1250	1250
6	ON	OFF	ON	850	850	900	1300	900	1300	1300
8	ON	OFF	OFF	950	950	1000	1500	1000	1500	1500
10	OFF	ON	ON	1025	1025	1200	1550	1200	1550	1550
15	OFF	ON	OFF	NR	NR	1440	1720	1440	1720	1780
19*	OFF	OFF	ON	NR	NR	1500	NR	1500	NR	NR
20				NR	NR	NR	1800	1500	1815	1850
21 or 25*	OFF	OFF	OFF	NR	NR	NR	NR	NR	1850	1850

Note: Airflow data shown applies to the electric heat only in either legacy mode or communicating mode operation

NR - Not Rated

* Within thermostat user menu, CTK0* communicating thermostat will display 20kW for OFF- OFF- ON dipswitch selection, 21kW for OFF-OFF-OFF dipswitch selection.

† For match up with a 2 ton outdoor unit: Heater kit application shall not exceed 10 kW. Airflow for 5 kW up to 10 kW heater kits shall be set to 850 cfm speed tap of ON-ON-ON.

†† For match up with a 3 ton outdoor unit: Heater kit application shall not exceed 15 kW. Airflow for 5 kW up to 15 kW heater kits shall be set to 1300 cfm speed tap of ON-OFF-ON.

††† For match up with a 3.5 ton outdoor unit: Heater kit application shall not exceed 20 kW. Airflow for 5 kW up to 20 kW heater kits shall be set to 1500 cfm speed tap of ON-OFF-OFF

** 3 kW heater kit is not applicable for this indoor application.

HEAT KIT DATA

Models	Circuit 1			Circuit 2			Single-Point Kit	
	Amps	MCA ¹	MOP ²	Amps	MCA ¹	MOP ²	MCA ¹	MOP ²
AVPTC24B14A*	0.0/0.0	4.9/4.9	15/15	---	---	---	---	---
HKS*03XC*	10.8/12.5	18/21	20/25	---	---	---	---	---
HKS*05XC*	17.3/20.0	27/30	30/30	---	---	---	---	---
HKS*06XC*	21.7/25.0	32/36	35/40	---	---	---	---	---
HKS*08XC*	28.9/33.3	41/47	45/50	---	---	---	---	---
HKS*10XC*	34.7/40.0	48/55	50/60	---	---	---	---	---
AVPTC30C14A*	0.0/0.0	4.9/4.9	15/15	---	---	---	---	---
HKS*03XC*	10.8/12.5	18/21	20/25	---	---	---	---	---
HKS*05XC*	17.3/20.0	27/30	30/30	---	---	---	---	---
HKS*06XC*	21.7/25.0	32/36	35/40	---	---	---	---	---
HKS*08XC*	28.9/33.3	41/47	45/50	---	---	---	---	---
HKS*10XC*	34.7/40.0	48/55	50/60	---	---	---	---	---
AVPTC36C14A*	0.0/0.0	6.5/6.5	15/15	---	---	---	---	---
HKS*03XC*	10.8/12.5	20/22	20/25	---	---	---	---	---
HKS*05XC*	17.3/20.0	28/32	30/35	---	---	---	---	---
HKS*06XC*	21.7/25.0	34/38	35/40	---	---	---	---	---
HKS*08XC*	28.9/33.3	43/48	45/50	---	---	---	---	---
HKS*10XC*	34.7/40.0	50/57	50/60	---	---	---	---	---
HKSX15XF*	0.0/0.0	6.5/6.5	15/15	30.0/34.6	38/43	40/45	---	---
HKSX20XF*	0.0/0.0	6.5/6.5	15/15	37.5/43.3	47/54	50/60	---	---
HKSC15*##	34.7/40.0	50/57	50/60	17.3/20.0	22/25	25/25	72/82	80/90
HKSC19C##	34.7/40.0	50/57	50/60	34.7/40	43/50	45/50	93/107	100/110
HKSC15XF*	0.0/0.0	6.5/6.5	15/15	30.0/34.6	38/43	40/45	---	---
AVPTC48C14AA	0.0/0.0	6.5/6.5	15/15	---	---	---	---	---
HKS*03XC*	10.8/12.5	20/22	20/25	---	---	---	---	---
HKS*05XC*	17.3/20.0	28/32	30/35	---	---	---	---	---
HKS*06XC*	21.7/25.0	34/38	35/40	---	---	---	---	---
HKS*08XC*	28.9/33.3	43/48	45/50	---	---	---	---	---
HKS*10XC*	34.7/40.0	50/57	50/60	---	---	---	---	---
HKSX15XF*	0.0/0.0	6.5/6.5	15/15	30.0/34.6	38/43	40/45	---	---
HKSX20XF*	0.0/0.0	6.5/6.5	15/15	37.5/43.3	47/54	50/60	---	---
HKSC15*##	34.7/40.0	50/57	50/60	17.3/20.0	22/25	25/25	72/82	80/90
HKSC19C##	34.7/40.0	50/57	50/60	34.7/40	43/50	45/50	93/107	100/110
HKSC15XF*	0.0/0.0	6.5/6.5	15/15	30.0/34.6	38/43	40/45	---	---
AVPTC42D14A*	0.0/0.0	6.5/6.5	15/15	---	---	---	---	---
HKS*03XC*	10.8/12.5	20/22	20/25	---	---	---	---	---
HKS*05XC*	17.3/20.0	28/32	30/35	---	---	---	---	---
HKS*06XC*	21.7/25.0	34/38	35/40	---	---	---	---	---
HKS*08XC*	28.9/33.3	43/48	45/50	---	---	---	---	---
HKS*10XC*	34.7/40.0	50/57	50/60	---	---	---	---	---
HKSX15XF*	0.0/0.0	6.5/6.5	15/15	30.0/34.6	38/43	40/45	---	---
HKSX20XF*	0.0/0.0	6.5/6.5	15/15	37.5/43.3	47/54	50/60	---	---
HKSC15*##	34.7/40.0	50/57	50/60	17.3/20.0	22/25	25/25	72/82	80/90
HKSC20D##	34.7/40.0	50/57	50/60	34.7/40	43/50	45/50	93/107	100/110
HKSC15XF*	0.0/0.0	6.5/6.5	15/15	30.0/34.6	38/43	40/45	---	---
HKSC20XF*	0.0/0.0	6.5/6.5	15/15	37.5/43.3	47/54	50/60	---	---

All ampacities noted above include air handler motor amps
 Circuit 1: Single-phase for Air Handlers / Circuit 2: Three-phase
 for HKR3 Heater Kits

¹ Minimum Circuit Ampacity (Heater Amps + Motor Amps) X 1.25

² Maximum Overcurrent Protection = 2.25 X Motor Amps + Heater Amps

* Revision level that may or may not be designated

C = Circuit Breaker Option

--- indicates Not Required

HKA meets the new UL1995 requirements for 15 and 20KW heaters

- Only applicable when HKA kits are included in table

- MBVC and MBR models

HEAT KIT DATA (CONT.)

Models	Circuit 1			Circuit 2			Single-Point Kit	
	Amps	MCA ¹	MOP ²	Amps	MCA ¹	MOP ²	MCA ¹	MOP ²
AVPTC48D14A*	0.0/0.0	6.5/6.5	15/15	---	---	---	---	---
HKS*03XC*	10.8/12.5	20/22	20/25	---	---	---	---	---
HKS*05XC*	17.3/20.0	28/32	30/35	---	---	---	---	---
HKS*06XC*	21.7/25.0	34/38	35/40	---	---	---	---	---
HKS*08XC*	28.9/33.3	43/48	45/50	---	---	---	---	---
HKS*10XC*	34.7/40.0	50/57	50/60	---	---	---	---	---
HKSX15XF*	0.0/0.0	6.5/6.5	15/15	30.0/34.6	38/43	40/45	---	---
HKSX20XF*	0.0/0.0	6.5/6.5	15/15	37.5/43.3	47/54	50/60	---	---
HKSC15*##	34.7/40.0	50/57	50/60	17.3/20.0	22/25	25/25	72/82	80/90
HKSC20D##	34.7/40.0	50/57	50/60	34.7/40.0	43/50	45/50	93/107	100/110
HKSC15XF*	0.0/0.0	6.5/6.5	15/15	30.0/34.6	38/43	40/45	---	---
HKSC20XF*	0.0/0.0	6.5/6.5	15/15	37.5/43.3	47/54	50/60	---	---
HKSC25DC*	52.0/60.0	72/82	80/90	34.7/40.0	43/50	45/50	115/132	125/150
AVPTC60D14A*	0.0/0.0	8.6/8.6	15/15	---	---	---	---	---
HKS*03XC*	10.8/12.5	22/24	25/25	---	---	---	---	---
HKS*05XC*	17.3/20.0	30/34	35/35	---	---	---	---	---
HKS*06XC*	21.7/25.0	36/40	40/40	---	---	---	---	---
HKS*08XC*	28.9/33.3	45/50	45/60	---	---	---	---	---
HKS*10XC*	34.7/40.0	52/59	60/60	---	---	---	---	---
HKSX15XF*	0.0/0.0	8.6/8.6	15/15	30.0/34.6	38/43	40/45	---	---
HKSX20XF*	0.0/0.0	8.6/8.6	15/15	37.5/43.3	47/54	50/60	---	---
HKSC15*##	34.7/40.0	52/59	60/60	17.3/20.0	22/25	25/25	74/84	80/90
HKSC20D##	34.7/40.0	52/59	60/60	34.7/40.0	43/50	45/50	95/109	100/110
HKSC15XF*	0.0/0.0	8.6/8.6	15/15	30.0/34.6	38/43	40/45	---	---
HKSC20XF*	0.0/0.0	8.6/8.6	15/15	37.5/43.3	47/54	50/60	---	---
HKSC25DC*	52.0/60.0	74/84	80/90	35/40	43/50	45/50	117/134	125/150

All ampacities noted above include air handler motor amps
 Circuit 1: Single-phase for Air Handlers / Circuit 2: Three-phase
 for HKR3 Heater Kits

¹ Minimum Circuit Ampacity (Heater Amps + Motor Amps) X 1.25

² Maximum Overcurrent Protection = 2.25 X Motor Amps + Heater Amps

* Revision level that may or may not be designated

C = Circuit Breaker Option

--- indicates Not Required

HKA meets the new UL1995 requirements for 15 and 20KW heaters

- Only applicable when HKA kits are included in table
- MBVC and MBR models

WIRING DIAGRAM - AIR HANDLER

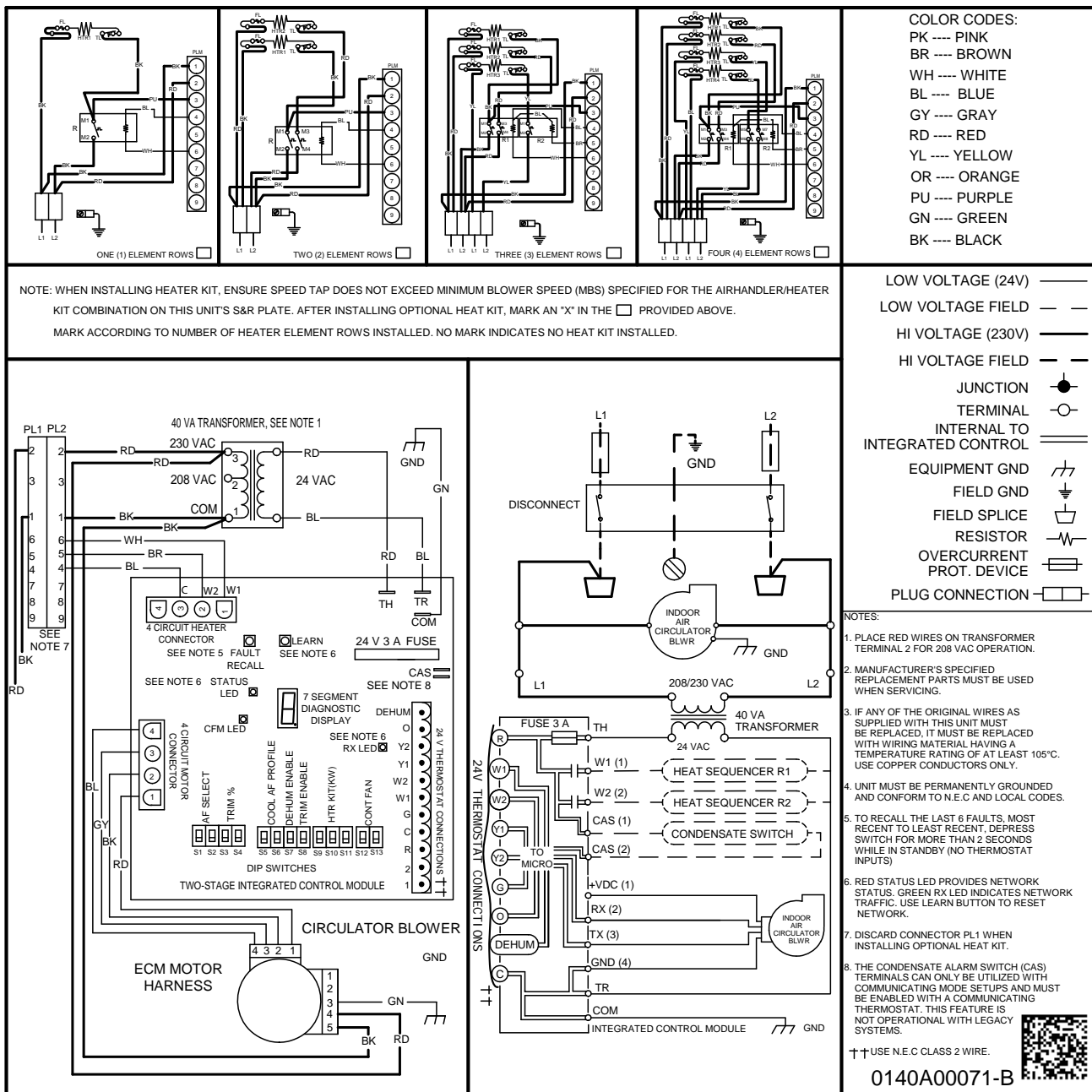

NOTE: The five element, 25 kW heater kit is not SHOWN ABOVE.

Wiring is subject to change. Always refer to the wiring diagram on the unit for the most up-to-date wiring.

WARNING	<p>High Voltage: Disconnect all power before servicing or installing this unit. Multiple power sources may be present. Failure to do so may cause property damage, personal injury, or death.</p>	
----------------	--	--

WIRING DIAGRAM - 5 ELEMENT HEATER KIT

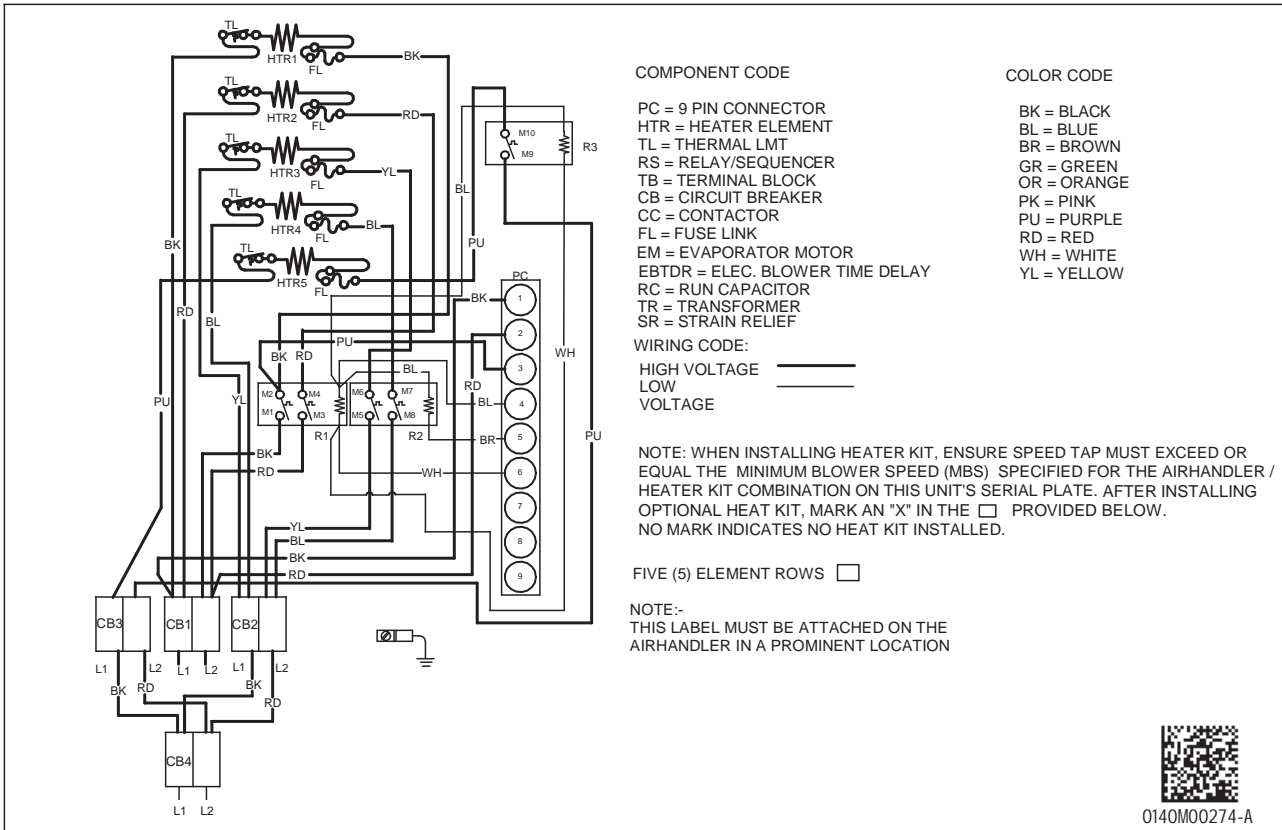

WIRING DIAGRAM - 3 PHASE HEATER KIT

NOTE: WHEN INSTALLING HEATER KIT, ENSURE SPEED TAP MUST EXCEED OR EQUAL THE MINIMUM BLOWER SPEED (MBS) SPECIFIED FOR THE AIRHANDLER/HEATER KIT COMBINATION ON THIS UNIT'S SERIAL PLATE.
 AFTER INSTALLING OPTIONAL HEAT KIT, MARK AN "X" IN THE PROVIDED BELOW.
 NO MARK INDICATES NO HEAT KIT INSTALLED.

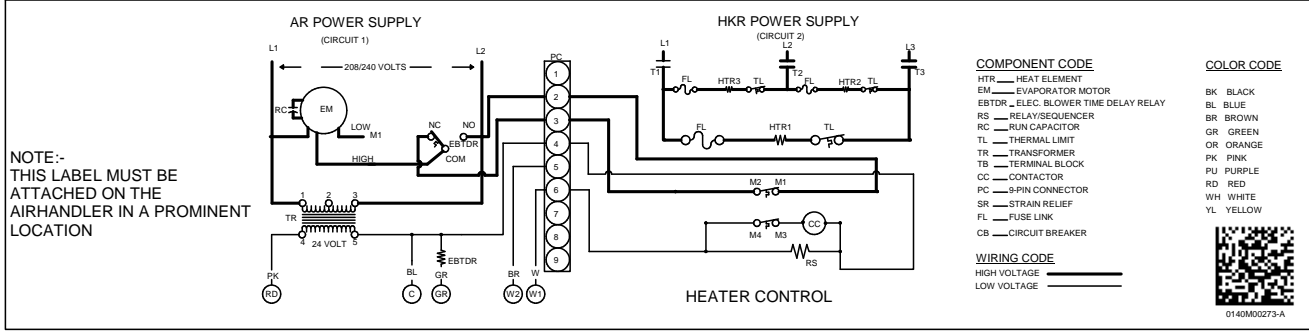
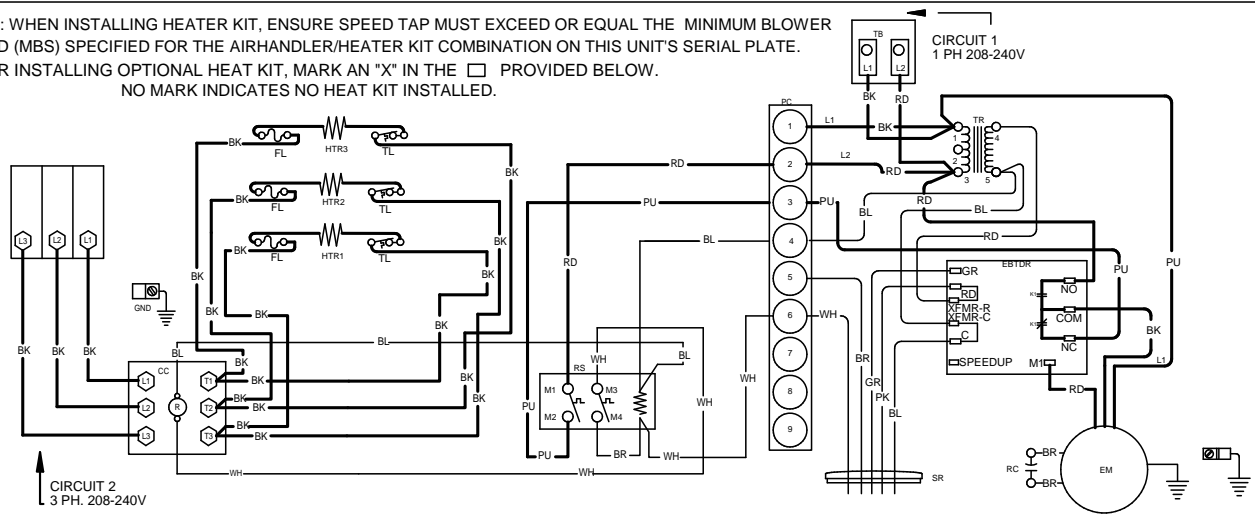

NOTE:- THIS LABEL MUST BE ATTACHED ON THE AIRHANDLER IN A PROMINENT LOCATION

COMPONENT CODE

- HTR - HEAT ELEMENT
- EM - EVAPORATOR MOTOR
- EBTDR - ELEC. BLOWER TIME DELAY RELAY
- RS - RELAY/SEQUENCER
- RC - RUN CAPACITOR
- TL - THERMAL LIMIT
- TR - TRANSFORMER
- TB - TERMINAL BLOCK
- CC - CONTACTOR
- PC - 9-PIN CONNECTOR
- SR - STRAIN RELIEF
- FL - FUSE LINK
- CB - CIRCUIT BREAKER

COLOR CODE

- BK - BLACK
- BL - BLUE
- BR - BROWN
- GR - GREEN
- OR - ORANGE
- PK - PINK
- PU - PURPLE
- RD - RED
- WH - WHITE
- YL - YELLOW

WIRING CODE

- HIGH VOLTAGE
- LOW VOLTAGE



0140M00273-A

PRODUCT SPECIFICATIONS

ACCESSORIES

DOWNFLOW KITS

DFK-B	DFK-C	DFK-D
AVPTC24B14A*	AVPTC30C14A*	AVPTC42D14**
	AVPTC36C14A*	AVPTC48D14**
	AVPTC48C14A*	AVPTC60D14**

FILTERS

CHASSIS	PART#	SIZE
B	ALFH16201E	16.0" x 20.0"
C	ALFH1912201E	19.5" x 20.0"
D	ALFH20231E	23.0" x 20.0"

SINGLE POINT KIT **

MODEL	HKR-15C	HKR-20C	HKR-21C
SPW-01	X	X	X

** Must be installed along with any of the above compatible heat kits. This kit will fit any AVPTC air handler as long as a compatible heat kit is installed in the unit.