



Product Catalog



Keeping your world flowing
with quality, innovative and easy-to-use products.



A global company with a focus on the individual customer.

The Fernco Joint Sealer Company was formally established in 1964 by an individual contractor looking for a time saving and reliable solution to his pipe connection needs. Mr. Zopfi developed a pre-formed tar donut for use on his own jobs in the Detroit area during the late 1940s.

Word spread of his invention as other contractors wanted to take advantage of this labor saving product and purchased them directly from Mr. Zopfi, who set up a small shop in a garage behind his plumbing business.









Since the beginning, Fernco has continued to grow into more markets and has continued to develop innovative, reliable and easy-to-use products. Fernco expanded into Canada and then to the West with a location in Reno, Nevada. In August, 2002, Fernco, Inc. acquired Flex-Seal Couplings LTD, the leading manufacturer of flexible couplings in the European market. Flex-Seal manufactures and distributes couplings in the United Kingdom and Europe. The Flex-Seal acquisition positions Fernco, Inc. as the number one manufacturer and distributor of flexible couplings in the world.

All of this growth isn't to make Fernco the biggest company, but the best company. With resources from around the world, Fernco is able to tap into many innovative minds to create the best products to meet the needs of the individual in the field, trying to get the job done, and done with confidence. From a company that started with one individual, it all comes down to our focus on the individual customer and providing you with a product you can trust.

Global Manufacturing

-  United States
-  Canada
-  United Kingdom
-  Germany
-  Australia

Global Distribution

-  United States
-  Canada
-  European Union
-  Australia
-  New Zealand
-  Puerto Rico
-  Mexico
-  China
-  Brazil



Our Commitment to You

Fernco is committed to giving you the highest level of quality, Fernco quality, at the most competitive price possible. Fernco's goal is to maintain standards of excellence in quality and service, while continuing to be the most innovative company in the industry.

Call For Convenient Ordering And Fast Delivery

Fernco's phone ordering system ensures easy ordering and prompt delivery for our customers. When you call Fernco you'll be assisted by a trained professional who knows the industry and understands your needs. Plus, your order will be quickly programmed into our data processing system for accurate recording of specifications and costs.

Only Fernco offers you the industry's largest product line, highest fill rate, and the most complete merchandising program. All of which is supported by over four decades of design, manufacturing and distribution experience combined with an ongoing commitment to product innovation.

United States
810-503-9000
 FX: 810-503-1015

Canada
519-332-6711
 FX: 519-332-8610

Page Index

HOT PRODUCTS

Pow-R Repair Products	4-5
Pow-R Wrap Industrial Size	6-7
QwikSeal	8-9
Storm Drain	10-11
Wax Free Toilet Seal	12
Wax Free Urinal Seal	13

FLEXIBLE COUPLINGS

Flexible Couplings	14-15
Coupling Sizing Charts	16-18
Plastic Socket Couplings	19
Ultra-Rib™ Pipe Couplings	19
Corrugated Pipe Couplings	19
Western Series Center Stop Couplings	20
Eccentric Couplings	20-21
Qwik Tees & Qwik Ells	22
Expansion Joints	23
Pipe Sleeve Seals	23
Flexible Tap Saddles	24
Tap Saddle Pressure Kit	25

SHIELDED COUPLINGS

Stainless Steel Band Clamps	26
Stainless Steel Shear Rings	26
Strong Back RC Couplings	27-28
5000 Series RC Couplings	30-31
Proflex Couplings	32-33
No-Hub Couplings	34-35

DONUTS / O-RINGS

Concrete Manhole Adapters	36
Large Diameter Waterstops	36
Donuts	37
Multi-Tite Pipe Gaskets	38
O-Rings	38

RESIDENTIAL

Qwik Caps	39
Hose Bibbs	39
Water Well Debris Traps	39
Flexible Qwik Traps	40
Drain & Trap Connectors	40
Tubular Drain Pipe Connector	41
Dishwasher Drain Connector	41
Shower Drain Connectors	42
Fix-A-Flange	42
Utility Connectors	43
Hose Grip Washer Connector	43
Downspout Connectors	44
Universal Downspout Conn.	44
Sump Pump Check Valve	45
Torque Wrenches	45

SALES REPS / ACID CHART

Plumbing Market Reps	46-47
Waterworks Market Reps	48-49
Acid Resistance	50





Pow-R Repair Products



Fernco Pow-R Repair Products are a growing family of products that will prove themselves in the field and earn their place in your toolbox. These products allow you to make fast, permanent repairs when time is not on your side and are an ideal solution for those after-hours emergency calls. You can get your customer's plumbing back up and running in minutes, instead of hours. Most repairs can be made in 15 minutes. *Ideal when your situation isn't.*



Pow-R Patch is a complete repair kit that includes a pre-coated fiberglass cloth in self-contained mixing pouch, one pair of protective gloves and installation instructions. Each simple-to-use kit will set on dry surfaces, and will adhere to PVC, metal, wood, fiberglass, plastic and MORE! Perfect for flat and round surface repairs.

Part No.	Description
FP-P46	Pow-R Patch - 4" x 6" fiberglass and epoxy patch



Pow-R Patch

- Unique self-contained mixing pouch
- Holds up to 100 PSI
- Heat resistant to 425° F
- Excellent adhesion to most materials



Universal PLUMBING, PIPE & HOSE Repair Kit

Ideal When Your Situation Isn't

Pow-R Pack is the ultimate in emergency repair kits. Containing Fernco's Pow-R Wrap, Pow-R Patch and Pow-R Stick in one Pow-R Pack, you will be ready for any leak that comes your way. You'll have the "Pow-R" to make a large variety of repairs all in one convenient, easy to carry pack.

Pow-R Pack Includes

- (1) Pow-R Wrap - 2" x 48"
- (1) Pow-R Patch - 4" x 6"
- (1) Pow-R Stick Epoxy Putty - 2 oz
- (2) Pair of protective gloves
- Complete installation instructions



Part No.	Description
FP-FM3P1	Pow-R Pack - Contains Pow-R Wrap, Pow-R Patch and Pow-R Stick





PIPE REPAIR

Water Activated Fiberglass Wrap

If You Can WRAP IT...You Can REPAIR IT!



HOT PRODUCTS

Pow-R Wrap

- Water activated fiberglass wrap
- Heat resistant to 425° F
- Conforms to a standard water main pressure test
- Safe for drinking water system repairs

Pow-R Wrap is a strong, permanent and economical repair. Works on virtually every kind of pipe and hose. It's an easy alternative to traditional methods such as cementing, soldering, welding, sleeving and replacement. It works on wet or dry pipes and even under water...salt or fresh.

Pow-R Wrap is a complete, self contained kit that includes a resin impregnated fiberglass tape in a foil bag, Pow-R Stick epoxy putty to enhance repairs, one pair of protective gloves and installation instructions. Three convenient sizes to choose from.



NO TOOLS NEEDED!



CURES IN 30 MIN!



STRONG! 600 PSI

THIS KIT IS FOR UP TO
1" DIA. PIPE
2" x 48" Wrap

THIS KIT IS FOR UP TO
3" DIA. PIPE
3" x 132" Wrap

THIS KIT IS FOR UP TO
6" DIA. PIPE
4" x 252" Wrap

Part No.	Description
FPW248CS	Pow-R Wrap - 2" x 48" to repair up to 1" diameter pipe
FPW3132CS	Pow-R Wrap - 3" x 132" to repair from 1 1/4" to 3" dia. pipe
FPW4252CS	Pow-R Wrap - 4" x 252" to repair from 3" to 6" dia. pipe



United States
PH: 810-503-9000
FX: 810-503-1015



www.fernco.com

Canada
PH: 519-332-6711
FX: 519-332-8610



NOW with Pow-R Belt

Fast emergency repairs for 8"-50" pipe.

- **Your Fast Repair Solution**

Pow-R Wrap cures in 60-90 minutes*

- **Easier Installation**

Pow-R Belt now allows for a hands-free cure time

- **Professional Results**

Pow-R Belt creates a smooth, tight finish every time

- **Strong, Cost Effective Repairs**

Pow-R Wrap is impervious to water, oil, chemicals, solvents and acids and conforms to a standard water main pressure test

Ideal for Municipalities, Industrial Parks, Marine, Water/Sewer Plants, Pump Stations, and even Chemical/Petroleum Plants

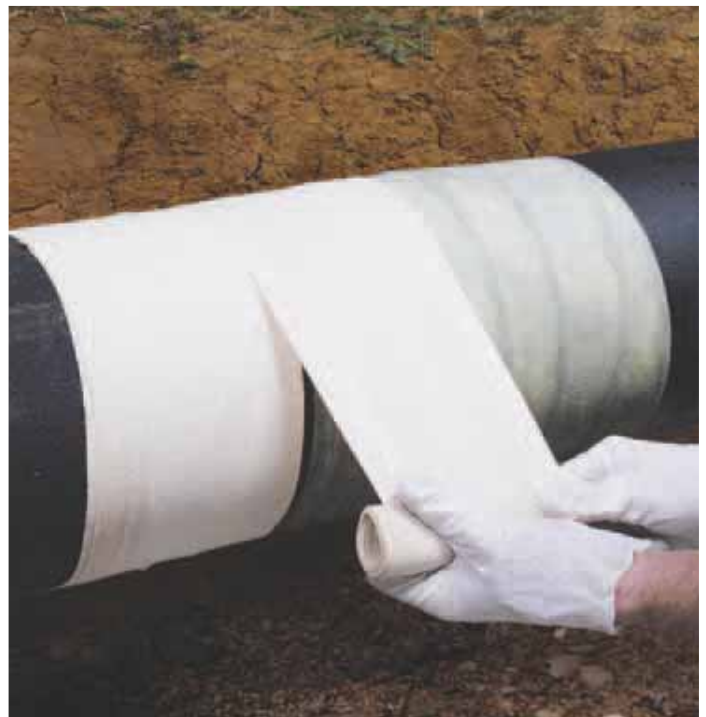

Fast • Easy • Permanent • Reduces Down Time • Saves Money



Easy Installation



Secured with Pow-R Belt



Hands-Free Cure Time



Professional Results

*55° - 75° F ideal installation temp. Higher or lower temps will influence cure time.

United States

PH: 810-503-9000
FX: 810-503-1015



www.fernco.com

Canada

PH: 519-332-6711
FX: 519-332-8610



NEW PRODUCTS

One SKU for Simplified Ordering

Fernco has simplified the process of selecting the right size Pow-R Wrap kit for your repair needs. With only one SKU in your inventory, and one to five kits on hand, you can make repairs on 8" to 50" outside diameter pipes. Repair cracks up to a 1/4" wide x 4" long.

Put multiple kits in your truck today and be ready for any size repair.



One of the sub-contractors hit the new 12" main water line for the new county building. They left a 10"X12" scratch about 2/3 into the thickness of the pipe, but did not actually pierce it.

We were adamant that we would not accept a brand new line with any of the traditional repair methods. Bands break and sleeving would have compromised the new pipe in multiple locations.

Pow-R-Wrap was the perfect solution and my staff did a magnificent job of applying the wrap (their first time too). We applied two wraps to get the recommended 8 layers, it set up beautifully. All of the on-site contractors were amazed at how easy and cost effective it was. The contractor even made the comment that we saved them easily over \$2,000.

Thank you Fernco!
Utilities Maintenance Supervisor

Part # FPW8540S-1 1 KIT 8" x 540" Pow-R Wrap					
PIPE OUTSIDE DIAMETER	8" - 18"	20"-24"	26" - 34"	36" - 42"	44" - 50"
Number of Kits REQUIRED for Pipe Size	1 KIT	2 KITS	3 KITS	4 KITS	5 KITS

Larger pipes require multiple kits to achieve the minimum number of layers of Pow-R Wrap for a proper repair.



United States
 PH: 810-503-9000
 FX: 810-503-1015



Canada
 PH: 519-332-6711
 FX: 519-332-8610



If you can **core through it**, QwikSeal can **connect to it**.

QwikSeal allows you to connect service pipe to solid wall, profile, closed profile and corrugated pipe.



Corrugated



SDR-35



Clay



Concrete & Manholes

Fernco QwikSeal

Part No.	Pipe Inlet	Pipe Size Application
QS-4	4" SDR-35	8" diameter and larger pipe
QS-4S40	4" SCH-40	8" diameter and larger pipe
QS-6	6" SDR-35	10" diameter and larger pipe
QS-6S40	6" SCH-40	10" diameter and larger pipe
QS-8	8" SDR-35	15" diameter and larger pipe

OTHERS	
QwikSeal Advantages	
Meets ASTM C 923	✓
When tested in Concrete Manholes:	✓
- Creates compression seal that is water tight up to 10 psi	✓
- Can handle up to 7 degrees of deflection	✓
Easy identification - Grey = Sch 40, Green = SDR-35	✓
Not dependant on the host pipe size, type or material	✓
Reduced complexity: 1 QwikSeal = Many Solutions	✓
Less inventory = More turns	✓

Fernco Hole Saws

Part No.	Description
QS-5x6HS	5" OD x 6" Deep Hole Saw with Arbor
QS-7x6HS	7" OD x 6" Deep Hole Saw with Arbor
QS-9x6HS	9" OD x 6" Deep Hole Saw with Arbor
QS-SAW5	5" OD x 6" Deep - HOLE SAW ONLY
QS-SAW7	7" OD x 6" Deep - HOLE SAW ONLY
QS-SAW9	9" OD x 6" Deep - HOLE SAW ONLY
QS-ARBOR	3/8" x 12" Drill with 1/2" Arbor
QS-ADAPTER	1 1/4" x 3/4" Coring Machine Adapter

Fernco Coring Bits

Part No.	Description
QS-5x14CB	5" OD x 14" Length Abrasive Coring Bit
QS-7x14CB	7" OD x 14" Length Abrasive Coring Bit
QS-9x14CB	9" OD x 14" Length Abrasive Coring Bit

United States
PH: 810-503-9000
FX: 810-503-1015



www.fernco.com

Canada
PH: 519-332-6711
FX: 519-332-8610

Installation Instructions



1.

Core a perpendicular hole to the main line:
 - 5" hole for 4" pipe inlet
 - 7" hole for 6" pipe inlet
 - 9" hole for 8" pipe inlet



2.

Using sand paper or a file, clean and remove any burrs from opening.



3.

Remove band clamp from QwikSeal, fold and insert into opening. Unfold.



4.

Pull up on QwikSeal until it stops against the inside of the pipe.



5.

Measure the depth of the QwikSeal, from the pipe stop to the top edge.



6.

Measure the depth of the fitting to be attached to the pipe stub.

See alternative method below.



7.

Add the dimensions of the QwikSeal and the fitting and cut a stub to that length.



8.

Bevel the leading edge of the pipe stub for easier insertion into the QwikSeal.



9.

Lubricate the QwikSeal and pipe stub.



10.

Start the pipe stub into the QwikSeal by hand.



11.

Using a hammer and block of wood, drive the pipe stub to the QwikSeal pipe stop.



12.

Install the band clamp at 60" lbs. torque.



13.

Install pipe fitting. Fitting should sit flush with the surface of the QwikSeal.



Fitting and QwikSeal should be flush.

Alternative methods to stub and fitting:

Bell End Pipe: You may also use the bell end of a piece of SDR-35 or SCH-40 instead of the stub and fitting method. After measuring the depth of the QwikSeal in step 5, transfer this measurement to the bell end of your inlet pipe, measuring from the bell. (Figure A) Proceed with steps 8 - 12.

Street Fittings: Street fittings may also be used with QwikSeal. (Figure B)



A.



B.

Connect lateral pipe and check for leaks prior to backfilling.



Your complete surface water drainage solution - strong & easy.

The durability & high performance of the Fernco Storm Drain ensures a long lasting, permanent solution to the collection and dispersal of standing surface water. The easy installation is ideal for driveways, pools, patios, walkways, sports courts and more.

- Made from 100% recycled polypropylene
- Bottom outlet accommodates 4" drain pipe
- No clips or screws required to assemble



APPLICATIONS

Driveways - Position between the garage and the driveway.

Patios - Drain water where it may be water pooling.

Swimming pools - Divert pool water away from grass or flower beds.

Sports Courts - Where standing water could prove to be a hazard.

Gardens - Where natural run off can be safely diverted.

Walkways - Drains pooling water safely and conveniently.



39.5" Channel
FSD-CHGG



90° Corner
FSD-90CGG



Contractor Pack
FSD-GP3G

Part No.	Description
FSD-CHGG	39.5" Storm Drain Channel with Grey Grate
FSD-GP3G	Storm Drain Contractor Pack: 3 pieces of Channel with Grey Grate, 1 End Cap & 1 End Outlet
FSD-90CGG	Storm Drain 90° Corner with Grey Grate
FSD-EC	Storm Drain End Cap - bagged
FSD-EO	Storm Drain End Outlet - bagged
FSD-LG	Storm Drain Leaf Guard - bagged

Replacement Parts

FSD-CH	Storm Drain Channel ONLY
FSD-GG	Storm Drain Grey Grate ONLY

United States

PH: 810-503-9000
FX: 810-503-1015



www.fernco.com

Canada

PH: 519-332-6711
FX: 519-332-8610

Strength By Design

Designed to withstand automotive vehicle weight without moving in concrete.

Meets Load Rating B*

HOT PRODUCTS

- Grates snap in and out, no screws required.

- Grates are concave to more efficiently trap & transfer water.



- Channel lengths are interlocking with a secure built-in joining system.

- Anti-floatation feet secure Channels in back fill or concrete.

- Cross braced ribs are designed into the body for strength and rigidity.

Bottom outlet in every Channel.

- Built in bottom outlet in each Channel is easily cut out with a utility knife and accommodates 4" sewer and drain pipes. The leaf guard also easily fits into the bottom outlet.

90° Corner
FSD-90CGG



90° Corner allows left or right hand extension of the Storm Drain

End Cap
FSD-EC



End Caps just slide into Storm Drain

Leaf Guard
FSD-LG



Leaf Guard prevents debris from going down drain pipe

End Outlet
FSD-EO



End Outlet accommodates 3" & 4" sewer and drain pipe OR 3" & 4" Sch. 40 fitting hub



Simple accessory attachment.



- The Storm Drain 90° Corner, End Cap and End Outlet just slide into the female end of the Channels. They also each have tabs to fit into the male end of the Channels or the cut to length end of the Channels.

No clips or screws required to assemble.

* **CLASS B:** Loads of 61-175 psi. Recommended for medium-duty pneumatic tire traffic, autos and light trucks at speeds less than 20 mph.



Wax Free Toilet Seal

The quick, clean and easy way to install a toilet.

Not only is it quick, clean and easy, but it is the only toilet seal that lets you *“feel the seal.”* As you lower the toilet onto the flange you can feel the unique sealing rings of the Wax Free Toilet Seal compress and seal against the inside walls of the drain pipe. NO mess. NO guess. Just confidence in a reliable seal. After all, it's made by Fernco.

FTS BENEFITS AND FEATURES

- **CONFORMS TO ASTM A 1045**
- Strong, flexible adhesive creates a positive seal to the bottom of the toilet
- Flexible ribs form a tight, positive seal to the inside of the drain pipe
- Seals on floors raised above the flange by up to 3/4"
- No need for flange risers or stacked wax rings
- Ideal for in-floor radiant heat installations
- Impervious to mold and mildew
- Centers itself and the toilet to the drain
- Will not melt or freeze in the extremes of your work truck
- Toilet can be removed and reinstalled with the same Fernco Wax Free Toilet Seal still attached
- Made of flexible PVC and will move with a wobbly toilet



Peel



Stick



Install



FTS-4 Is Ideal for most 4" Closet Wall Carriers

The **FTS-3** Wax Free Toilet Seal seals to the 3" inside diameter of 3" plastic, copper or cast iron drain pipe.

The **FTS-4** Wax Free Toilet Seal seals to the 4" inside diameter of 4" plastic, copper or cast iron drain pipe on both floor mounted and back outlet toilets. Including smooth wall 4" wall carrier models.

The **FTS-4CF** Wax Free Toilet Seal seals to the 3½" inside diameter of plastic toilet flanges install inside 4" plastic drain pipe. These flanges are sometimes referred to as a Combination Flange, Slab Flange, or 4x3 Flange.

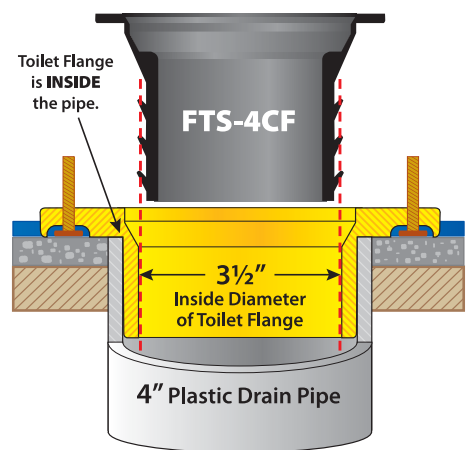
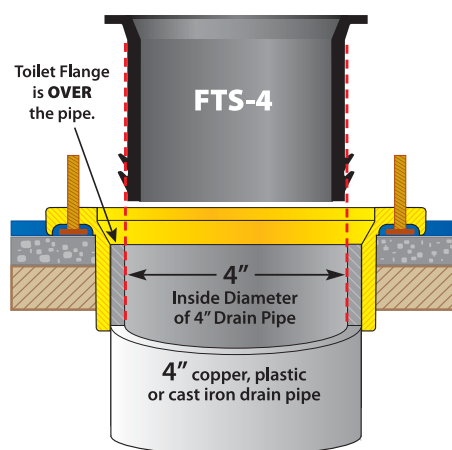
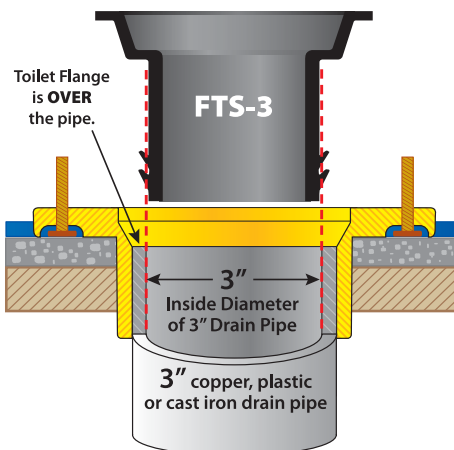



Wax Free Urinal Seal

Leak-Free, Hassle-Free, Worry-Free

HOT PRODUCTS



ASTM A 1045



FUS BENEFITS & FEATURES

- Fast, easy installation that provides a long term solution - even **reusable on the same urinal** during service calls
- Strong, flexible adhesive creates a positive seal with the urinal
- Engineered to seal to the inside diameter of the drain pipe forming a water tight, gas tight and odor tight seal
- Made of flexible PVC and will move with the urinal
- Will not absorb moisture or break down over time and is impervious to mold and mildew
- **Ideal for new installations and replacements**

Replace the failed foam seal **every time...**



...or install a Wax Free Urinal Seal **the first time!**



Part No.	Description
FUS-2	Wax Free Urinal Seal for 2" drain pipe

DIMENSIONS

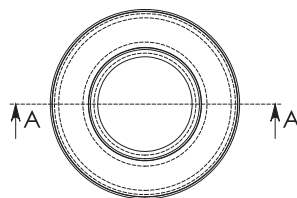
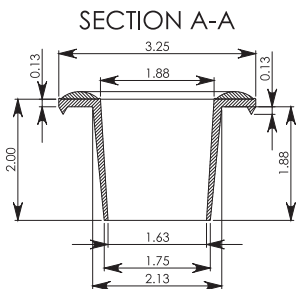

- Gasket Material: Plasticized PVC 75 Conforming to ASTM D 5926
- Adhesive: Permanent Pressure Sensitive Adhesive

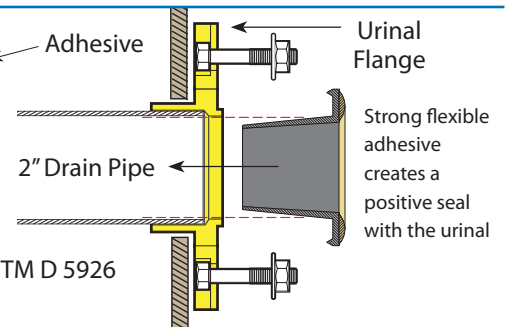

U.S. Patent Numbers: D655,796S; D655,795S; D655,400S; D649,625S

United States
PH: 810-503-9000
FX: 810-503-1015



Canada
PH: 519-332-6711
FX: 519-332-8610



Fernco Flexible Couplings

The industry standard for sewer, drain, waste & vent piping.

Specially formulated PVC compound positively seals any sewer and drain connection.

Because of their quality and ease of installation, Fernco Flexible Couplings have found wide acceptance among sewer and plumbing contractors and municipalities. Fernco couplings are used for all types of in-house and sewer applications: drain waste, repairs, vent piping, house-to-main, cut-ins, conductor and roof drains and increasers-reducers.

Made of tough elastomeric polyvinyl chloride (PVC), they are strong, resilient and unaffected by soil conditions. They are also resistant to chemicals, ultraviolet rays, fungus growth, and normal sewer gases due to the inert nature and physical properties

of the material. And they are leakproof, rootproof and seal against infiltration and exfiltration.

The dimensional flexibility of Fernco couplings ensures leakproof seals on virtually any pipe material: plastic, cast iron, asbestos cement, clay, concrete, steel, copper and ductile iron. All couplings are clearly marked with part number, size, and pipe materials that the coupling will connect. Fernco makes fast delivery of stock items with no minimum order required. For special applications, our custom design service can supply couplings to individual customer requirements.

All Fernco clamps, including the band screw and housing, are made from Series 300 Stainless Steel. Series 316 Stainless Steel Clamps are available upon request.



Tested designs backed by over four decades of proven performance.

- Positive seal against infiltration and exfiltration
- Leakproof, rootproof and are resistant to chemicals, ultraviolet rays, fungus growth, and normal sewer gases
- Conforms to ASTM D 5926, C 1173 and CSA B602
- Connects pipes of same or different sizes and materials quickly and easily
- Stainless steel clamps are corrosion-resistant and rustproof

Maximum test pressure: 4.3 PSI (29.6 KPA)

Maximum operating temperature: 140° F nonconsistent

For further information on code approvals, please contact the Fernco Customer Service Department.

United States
PH: 810-503-9000
FX: 810-503-1015



www.fernco.com

Canada
PH: 519-332-6711
FX: 519-332-8610



Stock Couplings



1056-075 coupling shown at approximately actual size of 2 3/8" high

Fernco makes the most complete line in the industry, from sizes of 3/4" to 27" (19mm to 381mm) with couplings available to connect any two pipes. Large Diameter Couplings are available and can be made to your specific requirements. Because Fernco Couplings have earned a reputation for consistent, superior performance, you can have full confidence in their quality and reliability.

Available from
 3/4" to 27"

Complete sizing charts on pages 14-16



1056-2727 coupling shown at actual size of 27" dia.

FLEXIBLE COUPLINGS

Large Diameter Couplings

For non-standard or special size applications.

The ideal coupling for repairs, alterations or rehabilitation of large diameter sewer pipe. These couplings are made from flexible PVC and offer easy installation and leak free connections. They are engineered for use with all common sewer piping materials: clay, concrete, cast and ductile iron, AC, plastic or fiberglass.



This product can be custom ordered for ANY common sewer pipe size and material combination.

LDC TECHNICAL SPECS

- Accommodates an O.D. difference of up to one inch*
- 12.7 inches wide
- 3/8 inch thick with multiple sealing ribs
- 2 - Series 300 (18-8) all stainless steel, extra strength (.040 in. thick) T-bolt clamps with multiple take up points
- Up to 150 in./lbs. of torque for greater sealing pressure.

Order LDCs by specifying the outside diameter (O.D.) of both pipes in inches.

**Where O.D. differences range from 1-1/4"- 4", a Fernco bushing system is available.*

NOTE: Never install this type of coupling until you read and understand the installation instructions and verify the dimensions ordered.



United States
 PH: 810-503-9000
 FX: 810-503-1015



www.fernco.com

Canada
 PH: 519-332-6711
 FX: 519-332-8610

Flexible Couplings - SIZING CHARTS for STOCK COUPLINGS

*Designated part numbers come with an insert bushing.

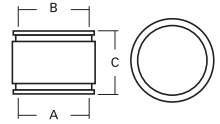

1001 Series - Clay to Clay

Part No.	A		B		C	
	in.	mm	in.	mm	in.	mm
1001-44	5.29	134	5.29	134	4.10	104
1001-44WC	5.51	140	5.51	140	3.97	101
1001-54	6.05	154	5.54	141	5.00	127
1001-55	6.48	165	6.48	165	5.97	152
1001-64	7.39	188	5.63	143	6.02	153
*1001-64WC	8.00	203	5.50	140	6.00	152
1001-65	7.35	187	6.61	168	5.76	146
1001-66	7.50	191	7.50	191	6.00	152
1001-66WC	8.01	203	8.01	203	5.91	150
*1001-84	9.50	241	5.13	130	5.68	144
*1001-86	9.50	241	7.13	181	5.68	144
1001-86WC	9.96	253	7.80	198	5.93	151
1001-88	9.65	245	9.65	245	6.00	152
1001-88WC	9.96	253	9.96	253	5.93	150
*1001-10-8	12.50	318	9.65	245	6.13	156
1001-1010	12.40	315	12.40	315	6.00	152
1001-1010WC	12.40	315	12.40	315	5.90	150
1001-1210	14.50	368	12.50	318	6.37	162
1001-1212	14.51	369	14.51	369	6.00	152
1001-1212WC	15.25	387	15.25	387	6.42	163
*1001-1510	18.14	461	12.60	320	10.14	258
*1001-1512	18.14	461	14.38	365	6.85	174
1001-1515	18.14	461	18.14	461	9.89	251
1001-1818	21.90	556	21.90	556	9.63	245
1001-2121	25.40	645	25.40	645	9.89	251
1001-2424	28.97	736	28.97	736	9.89	251
1001-2727	32.40	823	32.40	823	9.89	251



1002 Series - Clay to Cast Iron or Plastic

Part No.	A		B		C	
	in.	mm	in.	mm	in.	mm
*1002-42	5.25	133	2.38	60	3.91	99
1002-43	5.25	133	3.38	86	3.91	99
*1002-43WC	5.40	137	3.50	89	4.00	102
1002-44	5.14	131	4.52	115	3.96	101
1002-44WC	5.40	137	4.56	116	4.00	102
1002-46	5.18	132	6.39	162	5.82	148
*1002-54	6.05	154	4.38	111	5.28	134
*1002-54WC	6.84	174	4.29	109	5.93	151

1002-55	6.05	154	5.54	141	5.03	128
*1002-55WC	6.81	173	5.17	131	5.81	148
1002-64	7.34	186	4.50	114	5.56	141
*1002-64WC	8.00	203	4.50	114	6.00	152
1002-65	7.39	188	5.63	143	5.68	144
1002-66	7.35	187	6.61	168	5.76	146
1002-66WC	8.00	203	6.66	169	6.00	152
*1002-84	9.33	237	4.38	111	5.93	151
1002-86	9.33	237	6.20	157	5.93	151
*1002-86WC	10.00	254	6.38	162	6.00	152
1002-88	9.63	245	8.64	219	5.74	146
1002-88WC	10.00	254	8.66	220	6.00	152
*1002-10-6	12.50	318	6.38	162	6.38	162
*1002-10-8	12.50	318	8.50	216	6.13	156
1002-1010	12.50	318	10.50	267	5.88	149
1002-1010WC	12.60	320	10.60	269	6.37	162
*1002-1210	14.50	368	10.75	273	6.60	168
1002-1212	14.50	368	12.50	318	6.37	162
1002-1212WC	16.29	414	12.39	315	6.30	160
*1002-1215	15.38	391	14.38	365	6.32	161
*1002-12-8	14.50	368	8.50	216	6.60	168
*1002-1510	18.14	461	10.60	269	6.85	174
*1002-1512	18.14	461	12.60	320	6.85	174
1002-1515	18.14	461	15.60	396	6.85	174
1002-1515WC	19.82	503	15.43	392	9.68	246
1002-1818	21.90	556	18.88	480	9.63	245
*1002-1818WC	22.59	574	18.90	480	9.89	251
*1002-2121	25.40	645	22.30	566	10.14	258
*1002-2424	28.97	736	25.00	635	10.14	258
*1002-2727	32.40	823	28.20	716	10.14	258



1003 Series - Clay to Asbestos Cement Fibre or Ductile Iron

Part No.	A		B		C	
	in.	mm	in.	mm	in.	mm
1003-44	5.39	137	4.89	124	3.92	100
1003-44WC			5.00	127		
1003-46	5.17	131	6.81	173	5.81	148
*1003-54	6.05	154	5.00	127	5.28	134
1003-55	6.00	152	5.86	149	4.91	125
1003-64	7.39	188	5.63	143	5.68	144
*1003-64WC	8.01	203	5.00	127	5.95	151
*1003-65	7.35	187	5.90	150	6.00	152
1003-66	7.31	186	6.99	178	5.92	150
*1003-66WC	8.01	203	6.80	173	5.95	151



Flexible Couplings - SIZING CHARTS for STOCK COUPLINGS

*Designated part numbers come with an insert bushing.

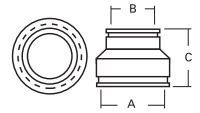

*1003-85	9.33	237	5.90	150	6.18	157
*1003-86	9.63	245	7.20	183	5.99	152
*1003-86WC	10.00	254	7.20	183	6.00	152
1003-88	9.50	241	9.00	229	5.99	152
*1003-88WC	9.96	253	9.05	230	5.93	151
*1003-8-10	11.05	281	9.65	245	5.95	151
*1003-1010	12.40	315	11.12	282	6.25	159
*1003-1010WC	12.40	315	11.12	282	6.00	152
*1003-10-6	12.40	315	6.80	173	6.25	159
*1003-10-8	12.50	318	9.05	230	6.13	156
*1003-1210	14.50	368	11.12	282	6.62	168
1003-1212	15.00	381	13.29	337	5.76	146
*1003-1212WC	15.25	387	13.20	335	6.42	163
*1003-12-8	14.50	368	9.05	230	6.62	168
*1003-1510	18.14	461	11.12	282	6.85	174
*1003-1512	18.14	461	13.20	335	6.85	174
*1003-1515	18.14	461	16.50	419	10.14	258
1003-1516	18.10	460	17.80	452	9.89	251
*1003-1818	21.60	549	19.50	495	9.89	251



1004 Series - Concrete to Concrete

Part No.	A		B		C	
	in.	mm	in.	mm	in.	mm
1004-44	5.51	140	5.51	140	3.97	101
*1004-64	7.67	195	5.62	143	5.86	149
1004-66	7.58	193	7.58	193	5.94	151
*1004-86	10.25	260	7.80	198	6.18	157
1004-88	10.38	264	10.38	264	5.90	150
1004-10-8	12.50	318	10.65	271	6.37	162
1004-99	Use part number 1001-1010					
1004-1010	12.40	315	12.40	315	6.00	152
*1004-1210	15.38	391	12.60	320	6.40	163
1004-1212	15.38	391	15.38	391	6.40	163
1004-1515	19.70	500	19.70	500	9.89	251
1004-1818	22.50	572	22.50	572	9.89	251
1004-2121	26.70	678	26.70	678	9.89	251
1004-2424	30.50	775	30.50	775	9.89	251
1004-2727	34.00	864	34.00	864	9.89	251



1005 Series - Concrete to Clay

Part No.	A		B		C	
	in.	mm	in.	mm	in.	mm
*1005-44	5.51	140	5.00	127	4.22	107
*1005-64	7.58	193	5.00	127	6.19	157
*1005-66	7.58	193	7.38	187	6.19	157
*1005-86	10.38	264	7.20	183	6.15	156
*1005-88	10.38	264	9.65	245	6.15	156
1005-1010	12.40	315	12.40	315	6.00	152
*1005-1210	15.38	391	12.60	320	6.40	163
*1005-1212	15.38	391	14.38	365	6.40	163
*1005-1512	19.82	503	14.38	365	9.68	246
*1005-1515	19.70	500	17.40	442	9.89	251



1006 Series - Concrete to Cast Iron or Plastic

Part No.	A		B		C	
	in.	mm	in.	mm	in.	mm
1006-43	5.61	142	3.53	90	3.90	99
1006-44	5.57	141	4.31	109	3.96	101
1006-46	5.46	139	6.48	139	5.77	147
1006-64	7.75	197	4.31	109	5.92	150
*1006-65	7.66	195	5.50	140	5.86	149
1006-66	7.66	195	6.65	169	5.86	149
*1006-68	7.80	198	8.64	219	6.04	153
*1006-84	10.25	260	4.38	111	6.18	157
*1006-86	10.25	260	6.38	162	6.18	157
1006-88	10.25	260	8.50	216	5.93	151
*1006-10-6	12.60	320	6.38	162	6.60	168
*1006-10-8	12.50	318	8.38	213	6.62	168
1006-1010	12.60	320	10.60	269	6.37	162
*1006-12-8	16.29	414	8.38	213	6.55	166
*1006-1210	16.29	414	10.75	273	6.55	166
1006-1212	16.29	414	12.39	315	6.30	160
*1006-1512	19.82	503	12.60	320	9.93	252
1006-1515	19.82	503	15.43	392	9.68	246
*1006-1818	22.50	572	18.90	480	9.89	251
*1006-2121	26.70	678	22.30	566	9.89	251
*1006-2424	30.50	775	25.00	635	9.89	251
*1006-2727	34.00	864	28.00	711	9.89	251

FLEXIBLE COUPLINGS

Flexible Couplings continued on page 16



Flexible Couplings - SIZING CHARTS for STOCK COUPLINGS

*Designated part numbers come with an insert bushing.

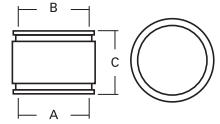

1051 Series - Asbestos Cement Fibre (AC) or Ductile Iron to Cast Iron or Plastic

Part No.	A		B		C	
	in.	mm	in.	mm	in.	mm
*1051-43	4.80	122	3.38	86	4.06	103
1051-44	4.80	122	4.53	115	4.06	103
*1051-45	5.00	127	5.52	140	4.22	107
*1051-46	4.75	121	6.60	168	5.99	152
1051-54	5.75	146	4.47	114	3.95	100
1051-55	6.05	154	5.54	141	5.03	128
*1051-56	5.90	150	6.60	168	5.99	152
1051-64	6.84	174	4.30	109	5.93	151
1051-65	6.81	173	5.17	131	5.81	148
1051-66	6.81	173	6.39	162	5.85	148
*1051-68	6.80	173	8.64	219	6.29	160
*1051-86	9.12	232	6.38	162	6.23	158
1051-88	9.12	232	8.49	216	5.98	152
*1051-10-8	11.05	281	8.38	213	5.95	151
1051-1010	11.05	281	10.65	271	5.95	151
*1051-1210	13.00	330	10.75	273	6.49	165
1051-1212	13.00	330	12.38	314	6.24	158
*1051-1215	15.44	392	13.20	335	10.00	254
1051-1515	15.90	404	15.90	404	9.89	251
1051-1615	18.14	461	15.60	396	6.85	174
1051-1818	19.70	500	18.90	480	9.89	251

*1055-1615	18.10	460	16.50	419	9.89	251
1055-1616	18.10	460	18.10	460	9.89	251
1055-1818	19.70	500	19.70	500	9.89	251



1056 Series - Cl, PL, Copper, ST or Lead to Cl, PL, Copper, ST or Lead

Part No.	A		B		C	
	in.	mm	in.	mm	in.	mm
1056-075	1.05	27	1.05	27	2.38	60
1056-100	1.31	33	1.31	33	2.40	61
1056-125	1.63	41	1.63	41	3.45	88
1056-150/125	1.94	49	1.63	41	3.45	88
1056-150	1.94	49	1.94	49	3.43	87
1056-215	2.41	61	1.84	47	3.39	86
1056-22	2.41	61	2.41	61	3.45	88
1056-300	2.95	75	2.95	75	2.70	69
1056-315	3.35	85	1.91	49	3.87	98
1056-32	3.52	89	2.38	60	3.96	101
1056-33	3.46	88	3.46	88	3.98	101
1056-415	4.40	112	1.91	49	3.96	101
1056-42	4.40	112	2.35	60	3.88	99
1056-43	4.46	113	3.52	89	4.03	102
1056-44	4.58	116	4.58	116	4.02	102
1056-53	5.61	142	3.53	90	3.90	99
1056-54	5.57	141	4.26	108	3.95	100
1056-55	5.52	140	5.52	140	3.97	101
*1056-63	6.61	168	3.38	86	5.75	146
1056-64	6.61	168	4.46	113	5.75	146
1056-65	6.48	165	5.46	139	5.77	147
1056-66	6.60	168	6.60	168	5.74	146
*1056-84	8.51	216	4.38	111	5.99	152
1056-86	8.51	216	6.38	162	5.99	152
1056-88	8.64	219	8.64	219	6.04	153
*1056-10-6	10.25	260	6.38	162	6.23	158
1056-10-8	10.25	260	8.42	214	5.98	152
1056-1010	10.63	270	10.63	270	5.89	150
*1056-12-8	12.50	318	8.38	213	6.62	168
1056-1210	12.50	318	10.65	271	6.37	162
1056-1212	12.52	318	12.52	318	6.32	161
1056-1512	15.75	400	12.25	311	5.71	145
1056-1515	15.44	392	15.44	392	10.00	254
*1056-1815	19.00	483	15.30	389	9.89	251
1056-1818	19.00	483	19.00	483	9.89	251
1056-2121	22.50	572	22.50	572	9.89	251
1056-2424	25.10	638	25.10	638	9.89	251
1056-2727	28.30	719	28.30	719	9.89	251



1055 Series - AC or Ductile Iron to AC or Ductile Iron

Part No.	A		B		C	
	in.	mm	in.	mm	in.	mm
1055-44	4.76	121	4.76	121	3.96	101
*1055-54	6.05	154	5.00	127	5.28	134
1055-55	6.00	152	5.86	149	4.91	125
*1055-63	6.81	173	3.38	86	5.56	141
1055-64	6.81	173	4.80	122	5.56	141
1055-65	6.84	174	5.89	150	5.88	149
1055-66	6.95	177	6.95	177	5.92	150
*1055-84	9.12	232	5.00	127	6.23	158
*1055-86	9.12	232	6.80	173	6.23	158
1055-88	9.05	230	9.05	230	5.98	152
*1055-10-8	11.05	281	9.05	230	5.95	151
1055-1010	10.86	276	10.86	276	5.91	150
*1055-12-8	13.00	330	9.05	230	6.24	158
*1055-1210	13.00	330	11.12	282	6.24	158
1055-1212	13.20	335	13.20	335	5.97	152
*1055-1512	16.80	427	13.20	335	9.89	251
1055-1515	16.80	427	16.80	427	9.89	251





Plastic Socket Couplings

For socket-to-pipe or socket-to-socket connections.

Couplings fit neatly over plastic pipes and sockets, making socket-to-pipe and socket-to-socket connections incredibly easy and reliable. They can even be used with plastic traps.



1059 Series -
Plastic Socket to Plastic Pipe

Part No.	A		B		C	
	in.	mm	in.	mm	in.	mm
1059-150	2.26	57	1.97	50	3.90	99
*1059-215	2.69	68	1.90	48	3.91	99
1059-22	2.70	69	2.40	61	3.91	99
*1059-32	3.99	101	2.38	60	3.99	101
1059-33	3.99	101	3.49	89	3.99	101
*1059-42	5.01	127	2.38	60	3.99	101
*1059-43	5.01	127	3.38	86	3.99	101
1059-44	5.01	127	4.50	114	3.99	101



Socket-to-Pipe



Socket-to-Socket



1060 Series -
Plastic Socket to Plastic Socket

Part No.	A		B		C	
	in.	mm	in.	mm	in.	mm
1060-150	2.26	57	2.26	57	3.92	100
1060-22	2.70	69	2.70	69	3.95	100
1060-33	3.94	100	3.94	100	3.97	101
1060-44	5.01	127	5.01	127	3.97	101

FLEXIBLE COUPLINGS

Ultra-Rib™ Sewer Pipe Couplings



1072 Series -
ETI x Asbestos Cement or Ductile Iron

Part No.	A		B		C	
	in.	mm	in.	mm	in.	mm
1072-1212	14.00	356	14.00	356	9.89	251
1072-1515	16.80	427	16.80	427	9.89	251



1073 Series -
ETI x SDR-35 Plastic

Part No.	A		B		C	
	in.	mm	in.	mm	in.	mm
*1073-1212	14.00	356	12.25	311	9.89	251
*1073-1515	16.80	427	15.30	389	9.89	251



1070 Series -
ADS and Hancor Corrugated Polyethylene to Plastic Pipe

Part No.	A		B		C	
	in.	mm	in.	mm	in.	mm
*1070-32	3.57	91	2.38	60	3.96	101
1070-33	3.57	91	3.44	87	3.96	101
*1070-42	4.76	121	2.38	60	3.94	100
*1070-43	4.76	121	3.38	86	3.94	100
1070-44	4.76	121	4.29	109	3.94	100
*1070-63	6.83	173	3.38	86	5.91	150
*1070-64	6.83	173	4.38	111	5.91	150
*1070-65	6.83	173	5.50	140	5.91	150
1070-66	6.83	174	6.50	165	5.91	150
*1070-84	9.76	248	4.38	111	5.70	145
*1070-86	9.76	248	6.38	162	5.70	145
1070-88	9.76	248	8.42	214	5.70	145

*Designated part numbers come with an insert bushing.

Corrugated Pipe Couplings



United States
PH: 810-503-9000
FX: 810-503-1015



www.fernco.com

Canada
PH: 519-332-6711
FX: 519-332-8610

Western Series Center Stop Couplings

TECHNICAL SPECS

- Center stop coupling design with bushing inserts
- Bushings available for most common 4", 6" and 8" transitions of clay, cast iron or plastic, and A/C to:
 - Sch. 40 PVC, ABS Plastic and SDR-35 Plastic
 - Bead, Bald, and Plain-End Cast Iron
 - Rough Barrel and Machined-End A/C
 - Ductile Iron
- 300 series stainless steel band clamps (316 available)



Bushings

Part No.	Description	Size
481-2.38	4" Clay x PECl	5.38" x 2.38"
481-3.38	4" Clay x PECl	5.38" x 3.38"
481-3.50	4" Clay x Bead CI\PL\XHCl	5.38" x 3.50"
481-4.25	4" Clay x SDR-35 / PVC	5.38" x 4.25"
481-4.38	4" Clay x PECl / Bald CI (J)	5.38" x 4.39"
481-4.50	4" Clay x ABS / Sch. 40	5.38" x 4.50"
481-4.63	4" Clay x Bead CI / MEAC (C)	5.38" x 4.63"
481-4.90	4" Clay x RBAC / CI 150 DI (B)	5.38" x 4.90"
681-6.38	6" Clay x PECl / PVC (J)	7.98" x 6.37"
681-6.63	6" Clay x ABS / Bead CI / MEAC (C)	7.98" x 6.62"
881-8.38	8" Clay x PECl / PVC (J)	10.18" x 8.42"
881-8.63	8" Clay x ABS / Bead CI / MEAC (C)	10.18" x 8.64"
881-9.00	8" Clay x RBAC / CI 150 DI (B)	10.18" x 9.00"
885-8.38	8" A/C x PECl / PVC (D)	9.00" x 8.42"
885-8.63	8" Clay x ABS / Bead CI / MEAC (AEK)	9.00" x 8.64"

Couplings

Part No.	Description	Size
1081-44	4" Clay x 4" Clay	5.44" x 5.44"
1081-66	6" Clay x 6" Clay	8.00" x 8.00"
1081-88	8" Clay x 8" Clay	10.00" x 10.00"
1085-88	8" A/C x 8" A/C	9.00" x 9.00"
1086-33	3" CI or PL x 3" CI or PL	3.40" x 3.40"
1086-44	4" CI or PL x 4" CI or PL	4.56" x 4.56"

One Piece Eccentric Coupling



When grade is critical, it's critical to use *Fernco* Eccentric Couplings.

EC TECHNICAL SPECS

- One piece Eccentric Coupling
- Connects 6" Clay to 4" CI or Plastic
- Aligns the inside wall of the pipes
- Provides an obstruction free flow
- Meets ASTM C 1173 and D 5926
- 300 series stainless steel clamps

1002 EC Series - Clay to Cast Iron or Plastic

Part No.	Description
1002-64EC	One piece eccentric connection of 6" Clay to 4" CI or PL

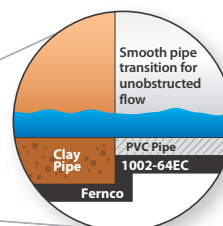
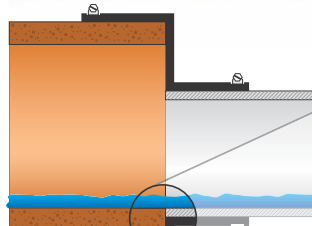

Competitor's Eccentric Coupling aligns the **outside** wall of the pipes creating an obstruction in the flow.

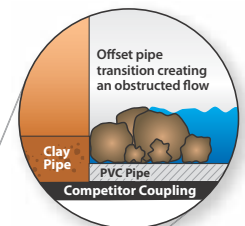

Fernco's Eccentric Coupling

aligns the **inside** wall of the pipes to create an obstruction free flow.

United States
PH: 810-503-9000
FX: 810-503-1015



www.fernco.com

Canada
PH: 519-332-6711
FX: 519-332-8610



Eccentric Bushings/Couplings

Maintaining a continuous flowline in critical grade conditions.



EB TECHNICAL SPECS

- Available for ALL common sewer pipe materials and sizes
- Aligns the inside wall of the two pipes
- Meets ASTM C 1173 and D 5926
- 300 series stainless steel clamps

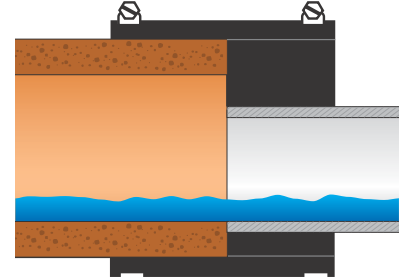

FLEXIBLE COUPLINGS

The following is a list of the more popular sewer pipe size / material combinations. Specific applications not listed here are available or can be custom ordered.

1002 EB Series - Clay to Cast Iron or Plastic

Part No.	Description
1002-42EB	Eccentric connection of 4" Clay to 2" CI or PL
1002-43EB	Eccentric connection of 4" Clay to 3" CI or PL
1002-44EB	Eccentric connection of 4" Clay to 4" CI or PL
1002-1212EB	Eccentric connection of 12" Clay to 12" CI or PL
1002-1215EB	Eccentric connection of 12" Clay to 15" CI or PL
1002-1512EB	Eccentric connection of 15" Clay to 12" CI or PL
1002-1515EB	Eccentric connection of 15" Clay to 15" CI or PL

1006 EB Series - Concrete to Cast Iron or Plastic

Part No.	Description
1006-44EB	Eccentric connection of 4" Concrete to 4" CI or PL
1006-64EB	Eccentric connection of 6" Concrete to 4" CI or PL

1051 EB Series -

Asbestos Cement Fibre (AC) or Ductile Iron to Cast Iron or Plastic

Part No.	Description
1051-10-6EB	Eccentric connection of 10" AC or DI to 6" CI or PL
1051-10-8EB	Eccentric connection of 10" AC or DI to 8" CI or PL
1051-12-4EB	Eccentric connection of 12" AC or DI to 4" CI or PL
1051-12-6EB	Eccentric connection of 12" AC or DI to 6" CI or PL

1055 EB Series -

Asbestos Cement Fibre (AC) or Ductile Iron to AC or Ductile Iron

Part No.	Description
1055-86EB	Eccentric connection of 8" AC or DI to 6" AC or DI
1055-12-8EB	Eccentric connection of 12" AC or DI to 8" AC or DI

1056 EB Series - CI, PL, Copper, ST or Lead to CI, PL, Copper, ST or Lead

Part No.	Description
1056-315EB	Eccentric connection of 3" CI or PL to 1½" CI or PL
1056-32EB	Eccentric connection of 3" CI or PL to 2" CI or PL
1056-415EB	Eccentric connection of 4" CI or PL to 1½" CI or PL
1056-42EB	Eccentric connection of 4" CI or PL to 2" CI or PL
1056-43EB	Eccentric connection of 4" CI or PL to 3" CI or PL
1056-54EB	Eccentric connection of 5" CI or PL to 4" CI or PL
1056-6/150EB	Eccentric connection of 6" CI or PL to 1½" CI or PL
1056-62EB	Eccentric connection of 6" CI or PL to 2" CI or PL
1056-63EB	Eccentric connection of 6" CI or PL to 3" CI or PL
1056-64EB	Eccentric connection of 6" CI or PL to 4" CI or PL
1056-65EB	Eccentric connection of 6" CI or PL to 5" CI or PL
1056-83EB	Eccentric connection of 8" CI or PL to 3" CI or PL
1056-84EB	Eccentric connection of 8" CI or PL to 4" CI or PL
1056-85EB	Eccentric connection of 8" CI or PL to 5" CI or PL
1056-86EB	Eccentric connection of 8" CI or PL to 6" CI or PL
1056-10-4EB	Eccentric connection of 10" CI or PL to 4" CI or PL
1056-10-6EB	Eccentric connection of 10" CI or PL to 6" CI or PL
1056-10-8EB	Eccentric connection of 10" CI or PL to 8" CI or PL
1056-12-6EB	Eccentric connection of 12" CI or PL to 6" CI or PL
1056-12-8EB	Eccentric connection of 12" CI or PL to 8" CI or PL
1056-1210EB	Eccentric connection of 12" CI or PL to 10" CI or PL
1056-1512EB	Eccentric connection of 15" CI or PL to 12" CI or PL

When ordering Eccentric Bushings/Couplings, please provide the pipe sizes and materials being connected.



This product can be custom ordered for ANY common sewer pipe size and material combination.

United States
PH: 810-503-9000
FX: 810-503-1015



www.fernco.com

Canada
PH: 519-332-6711
FX: 519-332-8610



Qwik Tees and Qwik Ells

Extra length fittings that are ideal for replacements.

FLEXIBLE COUPLINGS



Qwik Tees and Ells let you make 90° connections of all common household drain, waste and vent pipes quickly and easily without using special tools or fittings. Because they're exceptionally flexible and extra long, they're the ideal replacement for fittings cut out at the joint during alteration or repair. Reducing sizes are made with separately supplied Qwik Bushings.



Damaged or leaking fitting is cut out



The extra length of the Qwik Ell completes the repair



Qwik Tees - 90°

For CI, PL, Copper, ST or Lead Pipes

Part No.	A		B		C	
	in.	mm	in.	mm	in.	mm
QT-150	1.88	48	1.88	48	1.88	48
QT-200	2.31	59	2.31	59	2.31	59
QT-300	3.40	86	3.40	86	3.40	86
QT-400	4.52	115	4.52	115	4.52	115



Qwik Ells - 90°

For CI, PL, Copper, ST or Lead Pipes

Part No.	A		B	
	in.	mm	in.	mm
QL-150	1.90	48	1.90	48
QL-200	2.31	59	2.31	59
QL-300	3.44	87	3.44	87
QL-400	4.44	113	4.44	113

QT and QL TECHNICAL SPECS

- Extra length makes up for cut out fitting
- Flexibility makes for easy installation in limited spaces
- Reducing sizes can be made with insert Qwik Bushing
- 300 series stainless steel clamps



Qwik Bushings -

For Reducing Qwik Tees & Qwik Ells

Part No.	A		B	
	in.	mm	in.	mm
QB-215	2.37	60	1.88	48
QB-32	3.41	87	2.31	59
QB-43	4.00	101	3.00	76



United States

PH: 810-503-9000
FX: 810-503-1015



www.fernco.com

Canada

PH: 519-332-6711
FX: 519-332-8610



Expansion Joints

One piece design for trouble-free vertical pipe installations.

These expansion joints allow for thermal expansion and contraction of drain, waste and vent pipes and inside rain water conductor systems, eliminating costly offsets normally used to accommodate expansion and contraction.



Part No.	Nominal Pipe Size
XJ-150	1-1/2" (38mm)
XJ-2	2" (50mm)
XJ-3	3" (76mm)
XJ-4	4" (101mm)

Thermal Expansion Table for P.V.C. Pipe

Temp. Change Degrees F	Column 1 Expansion Per Ft. (Inches/mm)	Column 2 Limit Per Expansion Joint (Ft.)
50°0174 (.0442cm) 86
60°0209 (.0351cm) 71
70°0244 (.0620cm) 61
80°0278 (.0760cm) 54
100°0348 (.0884cm) 43

Fernco Expansion Joints will accommodate a maximum of 1-1/2" expansion and 1/2" contraction from a normal position. For A.B.S. pipe use 2 x value of Column 1 and 1/2 x value of Column 2.



FLEXIBLE COUPLINGS

XJ TECHNICAL SPECS

- Unique one-piece construction
- Internal stops of positive positioning
- No sliding parts to malfunction
- No packing to jam, freeze or leak
- Maintenance-free

Pipe Sleeve Seals



To seal pipe sleeves and carrier pipes.

Pipe-Sleeve Seals provide positive, mechanical seals around pipe sleeves and copper or plastic carrier pipe, above or below ground, to keep out dirt, water, and insects.

Carrier pipe slides easily through the Fernco pipe sleeve seal, for fast, convenient installation. Two all-stainless steel clamps tighten easily with a screw driver. No need for mastics or other sealing compounds that can damage plastic pipes.

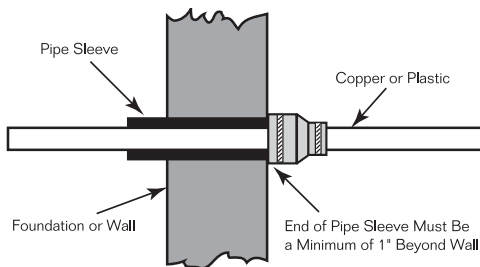

TECHNICAL SPECS

- Positive, mechanical seal around pipe sleeves and copper or plastic carrier pipe
- Use above or below ground
- No mastics or other sealing compounds needed
- 300 series stainless steel clamps

Part No.	Pipe Sleeve Size	Carrier Pipe Size
DTC 110	1-1/2"	3/4 or 1"
DTC 210	2"	3/4 or 1"
1056-315	3"	1-1/2"
1056-32	3"	2"
1056-415	4"	1-1/2"
1056-42	4"	2"
1056-43	4"	3"





Flexible Tap Saddles

The faster & less costly way to make sewer main connections.

One **Fernco** Saddle will fit ALL 6" and larger sewer mains.

TS TECHNICAL SPECS

- Conforms to ASTM D 5926
- Manufactured from a specially formulated high durometer PVC
- Rigid, yet flexible enough for one saddle to fit 6" or larger sewer mains
- Includes special "slip-lock" clamps of 300 series stainless steel that make for fast and simple installations on any type of pipe from 6" to 15"
- Larger apron with locating ring fits 5" or 7" standard shell cutters
- Large band grooves



TST-4



TSW-4

Available for all 4" or 6" plastic or cast iron drain pipe inlets in **Tee or Wye** configurations.

Part No.	Description
TST-4	4" Cast Iron or Plastic Inlet - Tee Tap Saddle
TST-6	6" Cast Iron or Plastic Inlet - Tee Tap Saddle
TSW-4	4" Cast Iron or Plastic Inlet - Wye Tap Saddle
TSW-6	6" Cast Iron or Plastic Inlet - Wye Tap Saddle
312-300	Extension Clamps - For larger than 15" sewer mains

NOTE: Flexible Tap Saddles provide a soil-tight seal. Use Fernco Tap Saddle Pressure Kit TSPK-46 for a water-tight connection.





Tap Saddle Pressure Kit

One size for use with Fernco models: TST-4, TST-6, TSW-4, TSW-6.



Provide your Flexible Tap Saddle installation with a water tight seal.



FLEXIBLE COUPLINGS

TSPK TECHNICAL SPECS

- Bentonite tape provides for a water tight seal
- Pressure tested to hold 10 PSI
- Rubber coated steel reinforcing bars apply even sealing pressure
- Two 300 series stainless steel clamps are "Slip-Lock" for fast and easy installation



Bentonite
tape
applied

Part No.	Description
TSPK-46	Pressure kit for Fernco Flexible Tap Saddles Fits model: TST-4, TST-6, TSW-4 and TSW-6

Special
"Slip-Lock"
band clamps



300 Series Stainless Steel Clamps



Part No.	For Diameters	Part No.	For Diameters
012-300	9/16" to 1-1/4"	104-300	5" to 7"
024-300	1-1/16" to 2"	116-300	5-3/4" to 7-3/4"
028-300	1-5/16" to 2-1/4"	128-300	6-1/2" to 8-1/2"
032-300	1-9/16" to 2-1/2"	140-300	7" to 9-1/4"
038-300	1-15/16" to 2-7/8"	152-300	8" to 10"
042-300	2-3/16" to 3-1/8"	164-300	8-3/4" to 10-3/4"
044-300	2-5/16" to 3-1/4"	184-300	10" to 12"
064-300	2-5/8" to 4-1/2"	196-300	10-3/4" to 12-3/4"
080-300	3-5/8" to 5-1/2"	212-300	11-3/4" to 13-3/4"
088-300	4-3/32" to 6"	248-300	14" to 16"
096-300	4-1/2" to 6-1/2"		

Interlocked housing and band design strengthens under tension to ensure a positive seal. Bands have additional slots to accommodate greater dimensional range.

Series 316 Stainless Steel Clamps are available upon request.

Stainless Steel Shear Rings

Add extra strength to just about any size Fernco coupling.



Fernco's stainless steel shear rings are easy to attach and help maintain proper alignment in even the most unstable ground conditions. Bushings are supplied separately for material transition and size reduction.

Stocked separately for convenient use with your regular inventory.

Part No.	Fits Fernco Coupling Part No.	Length	Width	Band Size
SR-9	1056-150	9"	1.5"	32
SR-11	1056-22	11"	1.5"	44
SR-15	1056-33	15"	2"	64
SR-19	1056-44, 1055-44	19"	2"	88
SR-22	1001-44, 1004-44, 1056-55	22"	2"	96
SR-25	1056-66	25"	4"	116
SR-27	1001-66, 1055-66	27"	4"	128
SR-28	1004-66	28"	4"	140
SR-33	1056-88	33"	4"	152
SR-35	1001-88, 1055-88	35"	4"	164
SR-37	1004-88	37"	4"	184
SR-39	1055-1010, 1056-1010	39"	4"	184
SR-46	1001-1010, 1004-1010, 1051-1212, 1055-1212, 1056-1212	46"	4"	(2) 116
SR-54	1001-1212, 1004-1212, 1056-1515	54"	4"	(2) 128
SR-59	1001-1515	59"	4"	(2) 152
SR-63	1056-1818	63"	4"	164 & 152
SR-73	1056-2121	73"	4"	(2) 184

Available for Fernco's 1-1/2" to 15" couplings with **CUSTOM SIZES** available.

SHEAR RING TECHNICAL SPECS

- Series 300 stainless steel bands, nuts, and housings
- Designed to fit Fernco coupling series:

1001 - Clay to Clay	1055 - AC to AC
1004 - Concrete to Concrete	1056 - CI/Plastic to CI/Plastic

United States
PH: 810-503-9000
FX: 810-503-1015



www.fernco.com

Canada
PH: 519-332-6711
FX: 519-332-8610

Strong Back RC Series Repair Couplings

Designed for resistance to heavy earth loads and shear forces and provides improved pipe alignment.

Strong Back RC Couplings offer a .012" stainless steel shield and a molded in bushing.



TECHNICAL SPECS & CODE APPROVALS

Gasket

- Manufactured to meet the material requirements of:
 - CSA B602 - mechanical couplings for drain, waste, vent pipe and sewer pipe
 - ASTM D 5926 - Standard Specification for Poly Vinyl Chloride (PVC) Gaskets for Drain, Waste, and Vent (DWV), Sewer, Sanitary, and Storm Plumbing Systems
 - ASTM C 1173 - Standard Specification for Flexible Transition Couplings for Underground Piping Systems
- Hardness, Shore "A", Inst. +5..... 65
- Tensile Strength, Min. psi 1000
- Elongation at Rupture, Min. %..... 250
- Tear Strength, Min..... 150 lb/in.
- Brittleness Temperature..... -40°F

Clamps

- Clamp Housing- 301 Stainless Steel
- Clamp Band - 301 Stainless Steel
- Clamp Screw - 305 Stainless Steel
- Installation torque 60" lbs

Shear Ring

- .012" Thick, 300 Series Stainless Steel
- Width manufactured according to coupling width (1.50", 2.13", or 4")
- Length manufactured according to coupling diameter
- Clamps spot welded in place

Coupling

- Manufactured to conform to the performance requirements of:
 - ASTM C 1173 - standard specification for flexible transition couplings for underground piping systems



This product can be custom ordered for ANY common sewer pipe size and material combination.

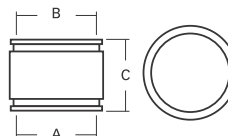

Part numbers on the next page...

Strong Back RC Couplings - RC Series Repair Couplings



1001 RC Series - Clay to Clay

Part No.	A		B		C	
	in.	mm	in.	mm	in.	mm
1001-44RC	5.29	134	5.29	134	4.10	104
1001-44WCRC	5.51	140	5.51	140	3.97	101
1001-64RC	7.50	191	5.50	140	6.02	153
1001-66RC	7.50	191	7.50	191	6.02	153
1001-66WCRC	8.00	203	8.00	203	6.00	152
1001-88RC	9.65	245	9.65	245	5.99	152
1001-88WCRC	10.00	254	10.00	254	6.00	152
1001-1010RC	12.40	315	12.40	315	5.90	150
1001-1010WCRC	12.40	315	12.40	315	5.90	150
1001-1212RC	14.51	369	14.51	369	6.38	162
1001-1212WCRC	15.25	387	15.25	387	6.42	163
1001-1515RC	18.14	461	18.14	461	9.89	251
1001-1818RC	21.90	556	21.90	556	9.63	245
1001-2424RC	28.97	736	28.97	736	9.89	251



1002 RC Series - Clay to Cast Iron or Plastic

Part No.	A		B		C	
	in.	mm	in.	mm	in.	mm
1002-43RC	5.29	134	3.38	86	4.10	104
1002-44RC*	5.36	136	4.51	115	4.07	103
1002-44WCRC*	5.44	138	4.55	116	3.96	101
1002-46RC	5.13	130	6.60	168	5.74	146
1002-55RC	6.60	168	5.50	140	5.74	146
1002-64RC	7.50	191	4.50	114	6.02	153
1002-64WCRC*	8.00	203	4.50	116	6.00	152
1002-64WCRC-SDR	8.00	203	4.38	111	6.00	152
1002-66RC*	7.50	191	6.56	167	5.89	150
1002-66WCRC*	8.04	204	6.38	162	5.91	150
1002-88RC*	9.76	248	8.57	218	5.96	151
1002-88WCRC*	10.00	254	8.66	220	6.00	152
1002-1010RC	12.40	315	10.75	273	5.90	150
1002-1010WCRC	12.40	315	10.75	273	5.90	150
1002-1210RC	14.51	369	10.60	269	6.00	152
1002-1212RC	14.51	369	12.60	320	6.38	162
1002-1212WCRC	15.25	387	12.60	320	6.42	163
1002-1215RC	14.38	365	15.25	387	6.42	163
1002-1515RC	18.14	461	15.40	391	9.89	251
1002-1818RC	21.90	556	19.00	483	9.63	245
1002-2121RC	25.46	647	22.30	566	9.89	251
1002-2424RC	28.97	736	25.00	635	9.89	251



1003 RC Series - Clay to Asbestos Cement Fibre (AC) or Ductile Iron

Part No.	A		B		C	
	in.	mm	in.	mm	in.	mm
1003-44RC*	5.41	137	4.94	125	4.07	103
1003-66RC*	7.25	184	6.84	174	5.93	151
1003-66WCRC	8.00	203	6.80	173	6.00	152
1003-68RC	7.20	183	9.05	230	5.98	152
1003-8-10RC	9.65	245	11.22	285	5.97	152
1003-88RC*	9.75	248	9.06	230	5.94	151
1003-1010RC	12.40	315	11.12	282	5.90	150
1003-1212RC	14.51	369	13.20	335	6.38	162
1003-1818RC	21.90	556	19.50	495	9.63	245



1004 RC Series - Concrete to Concrete

Part No.	A		B		C	
	in.	mm	in.	mm	in.	mm
1004-44RC	5.51	140	5.51	140	3.97	101
1004-66RC	7.58	193	7.58	193	5.94	151
1004-88RC	10.38	264	10.38	264	5.90	150
1004-1010RC	12.40	315	12.40	315	5.90	150
1004-1212RC	15.25	387	15.25	387	6.42	163
1004-1515RC	19.74	501	19.74	501	9.89	251



1006 RC Series - Concrete to Cast Iron or Plastic

Part No.	A		B		C	
	in.	mm	in.	mm	in.	mm
1006-44RC*	5.64	143	4.51	115	3.97	101
1006-64RC	7.58	193	4.38	111	5.94	151
1006-66RC*	7.63	194	6.63	168	5.94	151
1006-86RC	10.38	264	6.38	162	5.90	150
1006-88RC*	10.49	266	8.63	219	5.90	150
1006-1010RC	12.40	315	10.75	273	5.90	150
1006-1212RC	15.25	387	12.60	320	6.42	163
1006-1515RC	19.74	501	15.40	391	9.89	251

*Designated part numbers come with an insert bushing.



Strong Back RC Couplings - RC Series Repair Couplings



1051 RC Series - Asbestos Cement Fibre (AC) or Ductile Iron to Cast Iron or Plastic

Part No.	A		B		C	
	in.	mm	in.	mm	in.	mm
1051-44RC*	4.80	122	4.39	112	3.94	100
1051-45RC	5.00	127	5.52	140	3.97	101
1051-46RC*	4.75	121	6.60	168	5.74	146
1051-55RC	5.90	150	5.50	140	5.92	150
1051-64RC	6.95	177	4.38	111	5.92	150
1051-65RC	6.95	177	5.50	140	5.92	150
1051-66RC*	6.69	177	6.69	170	5.91	150
1051-8-10RC	9.05	230	10.63	270	5.89	150
1051-88RC*	9.25	235	8.51	216	5.97	152
1051-10-8RC	11.02	280	8.38	213	5.97	152
1051-1212RC	13.37	340	12.60	320	5.97	152
1051-1818RC	19.74	501	19.74	501	9.89	251



1055 RC Series - AC or Ductile Iron to AC or Ductile Iron

Part No.	A		B		C	
	in.	mm	in.	mm	in.	mm
1055-44RC	4.75	121	4.75	121	3.96	101
1055-66RC	6.65	169	6.65	169	5.92	150
1055-88RC	9.05	230	9.05	230	5.98	152
1055-1010RC	11.22	285	11.22	285	5.97	152
1055-1212RC	13.37	340	13.37	340	5.97	152



1056 RC Series - Cl, PL, Copper, ST or Lead to Cl, PL, Copper, ST or Lead

Part No.	A		B		C	
	in.	mm	in.	mm	in.	mm
1056-150RC	1.94	49	1.94	49	3.43	87
1056-22RC	2.41	61	2.41	61	3.45	88
1056-32RC	3.52	89	2.38	60	3.96	101
1056-33RC	3.46	88	3.46	88	3.98	101
1056-43RC	4.58	116	3.38	86	4.02	102
1056-44RC	4.58	116	4.58	116	4.02	102
1056-54RC	5.52	140	4.38	111	3.97	101
1056-55RC	5.52	140	5.52	140	3.97	101
1056-64RC*	6.60	168	4.50	114	5.74	146
1056-65RC	6.60	168	5.62	143	5.74	146
1056-66RC	6.60	168	6.60	168	5.74	146
1056-86RC	8.64	219	6.63	162	6.04	153
1056-88RC	8.64	219	8.64	219	6.04	153
1056-1010RC	10.63	270	10.63	270	5.89	150
1056-1212RC	12.52	318	12.52	318	6.32	161
1056-1515RC	15.92	404	15.92	404	9.89	251
1056-1818RC	19.10	485	19.10	485	9.89	251

SHIELDED COUPLINGS



This product can be custom ordered for ANY common sewer pipe size and material combination.

*Designated part numbers come with an insert bushing.



5000 Series Strong Back (RC) Couplings

Designed for resistance to heavy earth loads and shear forces, while providing improved pipe alignment.



5000 SERIES TECHNICAL SPECS

Gasket

- Manufactured to meet the material requirements of:
 - CSA B602 - mechanical couplings for drain, waste, vent pipe and sewer pipe
 - ASTM D 5926 - Standard Specification for Poly Vinyl Chloride (PVC) Gaskets for Drain, Waste, and Vent (DWV), Sewer, Sanitary, and Storm Plumbing Systems
 - ASTM C 1173 - Standard Specification for Flexible Transition Couplings for Underground Piping Systems
- Hardness, Shore "A", Inst. +5.....65
- Tensile Strength, Min. psi 1000
- Elongation at Rupture, Min. %.....250
- Tear Strength, Min..... 150 lb/in.
- Brittleness Temperature.....-40°F

Clamps

- Clamp Band - 316 Stainless Steel
- 6" and larger couplings incorporate two nut and bolt take-up points per band
- Installation torque 60" lbs

Shear Ring

- .012" Thick, 300 Series Stainless Steel
- Width manufactured according to coupling width (1.50", 2.13", or 4")
- Length manufactured according to coupling diameter
- Clamps spot welded in place

Coupling

- Manufactured to conform to the performance requirements of:
 - ASTM C 1173 - standard specification for flexible transition couplings for underground piping systems



Nut and Bolt Clamps



Molded-in Bushings



.012" Stainless Steel Shield



Resistance to Heavy Earth Loads

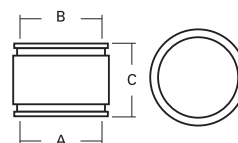

United States

PH: 810-503-9000
FX: 810-503-1015



www.fernco.com

Canada

PH: 519-332-6711
FX: 519-332-8610

5001 RC Series - Clay to Clay

Fernco Part No.	Mission Part No.	A		B		C	
		in.	mm	in.	mm	in.	mm
5001-44RC	MR01 44 ARC	5.29	134	5.29	134	4.10	104
5001-44WCRC	MR01 44 ARC	5.51	140	5.51	140	3.97	101
5001-66RC	N/A	7.50	191	7.50	191	6.02	153
5001-66WCRC	MR01 66 ARC	8.01	203	8.01	203	6.00	152
5001-88RC	MR01 88 ARC	9.65	245	9.65	245	5.99	152
5001-88WCRC	MR01 88 ARC	10.00	254	10.00	254	6.00	152
5001-1010RC	MR01 1010 ARC	12.40	315	12.40	315	5.90	150
5001-1212RC	MR01 1212 ARC	14.51	369	14.51	369	6.38	162
5001-1515RC	MR01 1515 ARC	18.14	461	18.14	461	9.89	251
5001-1818RC	MR01 1818 ARC	21.90	556	21.90	556	9.63	245

5002 RC Series - Clay to Cast Iron or Plastic

Fernco Part No.	Mission Part No.	A		B		C	
		in.	mm	in.	mm	in.	mm
5002-43RC	MR02 43 ARC	5.29	134	3.38	86	4.10	104
5002-44RC*	MR02 44 ARC	5.36	136	4.51	115	4.07	103
5002-44WCRC*	MR02 44 ARC	5.44	138	4.55	116	3.96	101
5002-46RC	MR02 46 ARC	7.50	191	5.13	130	6.02	153
5002-55RC	MR02 55 ARC	6.60	168	5.50	140	5.74	146
5002-64RC	MR02 64 ARC	7.50	191	4.50	114	6.02	153
5002-64WCRC*	MR02 64 ARC	8.02	204	4.57	116	6.00	152
5002-66RC*	MR02 66 ARC	7.50	191	6.56	167	5.89	150
5002-66WCRC*	MR02 66 ARC	8.04	204	6.38	162	5.91	150
5002-86RC	MR02 86 ARC	9.65	245	6.63	168	6.00	152
5002-88RC*	MR02 88 ARC	9.76	248	8.57	218	5.96	151
5002-88WCRC*	MR02 88 ARC	10.00	254	8.66	220	6.00	152
5002-1010RC	MR02 1010 ARC	12.40	315	10.75	273	5.90	150
5002-1212RC	MR02 1212 ARC	14.51	369	12.60	320	6.38	162
5002-1515RC	MR02 1515 ARC	18.14	461	15.40	391	9.89	251
5002-1818RC	MR02 1818 ARC	21.90	556	19.00	483	9.63	245

5003 RC Series - Clay to Asbestos Cement Fibre or Ductile Iron

Fernco Part No.	Mission Part No.	A		B		C	
		in.	mm	in.	mm	in.	mm
5003-44RC*	MR03 44 ARC	5.41	137	4.94	125	4.07	103
5003-66RC*	MR03 66 ARC	7.25	184	6.84	174	5.93	151
5003-88RC*	MR03 88 ARC	9.75	248	9.06	230	5.94	151
5003-1212RC	MR03 1212 ARC	14.51	369	13.20	335	6.38	162
5003-1516RC	MR03 1516 ARC	18.10	460	18.10	460	9.89	251

5004 RC Series - Concrete to Concrete

Fernco Part No.	Mission Part No.	A		B		C	
		in.	mm	in.	mm	in.	mm
5004-44RC	MR05 44 ARC	5.51	140	5.51	140	3.97	101
5004-66RC	MR04 66 ARC	7.58	193	7.58	193	5.94	151
5004-88RC	MR04 88 ARC	10.38	264	10.38	264	5.90	150

5004-1010RC	MR04 1010 ARC	12.40	315	12.40	315	5.90	150
5004-1212RC	MR04 1212 ARC	15.25	387	15.25	387	6.42	163
5004-1212LCRC	MR04 1212 ARC	16.10	409	16.10	409	9.89	251

5006 RC Series - Concrete to Cast Iron or Plastic

Fernco Part No.	Mission Part No.	A		B		C	
		in.	mm	in.	mm	in.	mm
5006-44RC*	MR06 44 ARC	5.51	140	4.50	114	3.97	101
5006-66RC*	MR06 66 ARC	7.58	193	6.63	168	5.94	151
5006-88RC*	MR06 88 ARC	10.38	264	8.50	216	5.90	150
5006-1010RC	MR06 1010 ARC	12.40	315	10.75	273	5.90	150
5006-1212RC	MR06 1212 ARC	15.25	387	12.60	320	6.42	163
5006-1212LCRC	MR06 1212 ARC	16.10	409	12.60	320	9.89	251

5051 RC Series - AC or Ductile Iron to CI or PL

Fernco Part No.	Mission Part No.	A		B		C	
		in.	mm	in.	mm	in.	mm
5051-44RC*	MR51 44 ARC	4.80	122	4.39	112	3.94	100
5051-46RC*	N/A	6.60	168	4.75	121	5.74	146
5051-64RC	N/A	6.95	177	4.38	111	5.92	150
5051-66RC*	MR51 66 ARC	6.96	177	6.69	170	5.91	150
5051-88RC*	MR51 88 ARC	9.25	235	8.51	216	5.97	152
5051-1010RC*	MR51 1010 ARC	11.02	280	10.52	267	5.85	148
5051-1212RC	MR51 1212 ARC	13.20	335	12.60	320	5.97	152
5051-1615RC	MR51 1615 ARC	18.14	461	15.40	391	9.89	251

5055 RC Series - AC or Ductile Iron to AC or Ductile Iron

Fernco Part No.	Mission Part No.	A		B		C	
		in.	mm	in.	mm	in.	mm
5055-44RC	MR55 44 ARC	4.75	121	4.75	121	3.96	101
5055-66RC	MR55 66 ARC	6.65	169	6.65	169	5.92	150
5055-88RC	MR55 88 ARC	9.05	230	9.05	230	5.98	152

5056 RC Series - CI, PL, or Steel to CI, PL, or Steel

Fernco Part No.	Mission Part No.	A		B		C	
		in.	mm	in.	mm	in.	mm
5056-43RC	MR56 43 ARC	4.58	116	3.38	86	4.02	102
5056-44RC	MR56 44 ARC	4.58	116	4.58	116	4.02	102
5056-44XLR	N/A		0		0		0
5056-54RC	MR56 54 ARC	5.52	140	4.38	111	3.97	101
5056-55RC	MR56 55 ARC	5.52	140	5.52	140	3.97	101
5056-64RC*	MR56 64 ARC	6.60	168	4.50	114	5.74	146
5056-66RC	MR56 66 ARC	6.60	168	6.60	168	5.74	146
5056-88RC	MR56 88 ARC	8.64	219	8.64	219	6.04	153
5056-1010RC	MR56 1010 ARC	10.63	270	10.63	270	5.89	150
5056-1212RC	MR56 1212 ARC	12.52	318	12.52	318	6.32	161
5056-1515RC	MR56 1515 ARC	15.44	392	15.44	392	9.89	251
5056-1818RC	MR56 1818 ARC	19.00	483	19.00	483	9.89	251
5056-2424RC	N/A	25.10	638	25.10	638	9.89	251





Proflex Specialty Couplings

Shielded transition couplings designed for resistance to shear forces.



SHIELDED COUPLINGS

PROFLEX
Specialty Couplings By *Fernco, Inc.*

Proflex allows you to make transition pipe connections that are resistant to shear forces, while creating a rigid, long-lasting pipe joint. From 1 1/2" to 8" - PROFLEX connects cast iron, plastic, steel, copper and tubular drain waste and vent systems.



PROFLEX TECHNICAL SPECS

Proflex Shielded Couplings: ASTM C 1460 and CSA B602

Gasket Material: Neoprene - ASTM C 564

Gasket ID: Part No. and application on each gasket.

Shield Assembly Material Requirements:

All 300 Series Stainless Steel

Clamp

Band = 301 Stainless Steel .025 x .500 x Length

Housing = 301 Stainless Steel - Fernco

Screw = 305 Stainless Steel 5/16" Hex - No Slot

Shield

301 Stainless Steel .012 x 2.125 x Length

Eyelet

305 Stainless Steel

Note: Installation torque = 60" lbs.



3000 Series Proflex- Cast Iron to Plastic, Steel or Extra-Heavy Cast Iron

Part No.	Description	Mission
3000-150	1-1/2" CI, PL or ST to 1-1/2" CI, PL, ST	CP-150
3000-215	2" CI, PL or ST to 1-1/2" CI, PL, ST	CP-215
3000-22	2" CI, PL or ST to 2" CI, PL, ST	CP-200
3000-33	3" CI, to 3" PL, ST or XH CI	CP-33
3000-43	4" CI, to 3" PL, ST or XH CI	CP-43
3000-44	4" CI, to 4" PL, ST or XH CI	CP-44
3000-55	5" CI, to 5" PL, ST or XH CI	CP-55
3000-66	6" CI, to 6" PL, ST or XH CI	CP-66
3000-88	8" CI, to 8" PL, ST or XH CI	CP-88

United States

PH: 810-503-9000
FX: 810-503-1015



www.fernco.com

Canada

PH: 519-332-6711
FX: 519-332-8610

Proflex Specialty Couplings - Shielded transition couplings.



3001 Series Proflex- Cast Iron to Copper

Part No.	Description	Mission
3001-110	1-1/2" CI, PL or ST to 1" Copper or 3/4" PL	CK-110
3001-1125	1-1/2" CI, PL or ST to 1-1/4" Copper or 1" PL	CK-1125
3001-150	1-1/2" CI, PL or ST to 1-1/2" Copper or 1-1/4" PL	CK-115
3001-2125	2" CI, PL or ST to 1 1/4" Copper or 1" PL	CK-2125
3001-215	2" CI, PL or ST to 1-1/2" Copper or 1-1/4" PL	CK-215
3001-22	2" CI, PL or ST to 2" Copper	CK-22
3001-315	3" CI to 1-1/2" Copper or 1-1/4" PL	CK-315
3001-32	3" CI to 2" Copper	CK-32
3001-33	3" CI to 3" Copper	CK-33
3001-43	4" CI to 3" Copper	CK-43
3001-44	4" CI to 4" Copper	CK-44



3002 Series Proflex- Cast Iron, Plastic or Steel to Tubular

Part No.	Description	Mission
3002-150	1-1/2" CI, PL or ST to 1-1/2" Tubular	T-150
3002-155	1-1/2" Tubular to 1-1/2" Tubular	BWT-150
3002-215	2" CI, PL or ST to 1-1/2" Tubular	T-215



3003 Series Proflex- Copper to Copper

Part No.	Description	Mission
3003-150	1-1/2" Copper to 1-1/2" Copper or 1-1/4" PL	K-150
3003-215	2" Copper to 1-1/2" Copper or 1-1/4" PL	K-215
3003-22	2" Copper to 2" Copper	K-200
3003-33	3" Copper to 3" Copper	K-300



3004 Series Proflex- Cast Iron to Cast Iron, Plastic or Steel

Part No.	Description	Mission
3004-320	3" CI, to 2" CI, PL, or ST	C-320
3004-420	4" CI, to 2" CI, PL, or ST	C-420
3004-430	4" CI, to 3" CI	C-430
3004-540	5" CI, to 4" CI	C-540



3005 Series Proflex- Plastic, Steel, or XHCI to Plastic Steel or XHCI

Part No.	Description	Mission
3005-33	3" PL, ST, or XH CI, to 3" PL, ST, or XH CI	P-300
3005-43	4" PL, ST, or XH CI, to 3" PL, ST, or XH CI	P-430
3005-44	4" PL, ST, or XH CI, to 4" PL, ST, or XH CI	P-400
3005-66	6" PL, ST, or XH CI, to 6" PL, ST, or XH CI	P-600



3006 Series Proflex- Copper to Cast Iron, Plastic or Steel

Part No.	Description	Mission
3006-215	2" Copper to 1-1/2" CI, PL, or ST	KC-215
3006-32	3" Copper to 2" CI, PL, or ST	KC-32
3006-43	4" Copper to 3" CI	KC-43



3007 Series Proflex- Plastic, Steel, or Extra-Heavy Cast Iron to Copper

Part No.	Description	Mission
3007-32	3" PL, ST or XH CI to 2" Copper	PK-32
3007-33	3" PL, ST or XH CI to 3" Copper	PK-33
3007-43	4" PL, ST or XH CI to 3" Copper	PK-43
3007-44	4" PL, ST or XH CI to 4" Copper	PK-44



3008 Series Proflex- Plastic, Steel, or XHCI to Cast Iron, Plastic or Steel

Part No.	Description	Mission
3008-32	3" PL, ST, or XH CI, to 2" CI PL, or ST,	PC-32



3009 Series Proflex- Thin Wall Plastic to Sch. 40 Plastic

Part No.	Description	Mission
3009-33	3" Thinwall Plastic to 3" Sch. 40 Plastic.	TWP-33
3009-44	4" Thinwall Plastic to 4" Sch. 40 Plastic	TWP-44



3010 Series Proflex- Copper to Tubular

Part No.	Description	Mission
3010-150	1-1/2" Copper to 1-1/2" Tubular	KT-150
3010-215	2" Copper to 1-1/2" Tubular	KT-215

No-Hub Couplings

Engineered to connect No-Hub cast iron pipe.



SHIELDED COUPLINGS

Choose the No-Hub Coupling with the patented shield design that provides maximum transfer of pressure from the clamps - to the gasket - to the pipe. Engineered to connect no-hub cast iron pipe in applications replacing the less-efficient hub and spigot.

NO-HUB TECHNICAL SPECS



Patented Bi-Directional Shield Design

The shield will adjust to variations in diameters and circumferences of the pipes being joined, thereby eliminating leak paths. The patented, bi-directional corrugations exert sealing pressure in both parallel and transverse patterns on the gasket and pipe, providing a positive, reliable seal.



Interlocking Clamp Design

The clamps feature a one-piece screw housing that mechanically interlocks the housing to the band. This one-piece housing design eliminates leak paths that can occur in stacked or welded clamps.



Specially Beaded Gasket

Made of an elastomeric compound that meets the requirements of ASTM C564 and features a series of strategically positioned grooves and beads. When tightened, the shield mates with these grooves and beads to exert exceptional sealing pressure and holding power to prevent "pull out" failures.



Floating Eyelet Design

Floating eyelets fasten the clamps to the shield, allowing the clamp band and shield to move independently. This freedom prevents the shield from crimping during tightening, which can lead to leakage later on.

United States

PH: 810-503-9000
FX: 810-503-1015



www.fernco.com

Canada

PH: 519-332-6711
FX: 519-332-8610

No-Hub Couplings - For drain, waste & vent piping.

Standard No-Hub



5/16" hex-head screw applies 60 in.-lbs. of installation torque to the band/shield assembly.

Standard No-Hub Couplings conform to CISPI 310. Couplings comply with ASTM C1277. Gaskets are made from an elastomeric compound that meets the requirements of ASTM C564.

PART NUMBER	SIZE	CLAMPS PER COUPLING	INSTALL TORQUE (inch pounds)
NH-150	1-1/2"	2	60
NH-22	2"	2	60
NH-33	3"	2	60
NH-44	4"	2	60
NH-55	5"	4	60
NH-66	6"	4	60
NH-88	8"	4	60
NH-1010	10"	4	60
NH-1212	12"	6	120
NH-1515	15"	6	120

REDUCING SIZE NO-HUB

NH-215	2" x 1-1/2"	2	60
NH-32	3" x 2"	2	60
NH-42	4" x 2"	2	60
NH-43	4" x 3"	2	60

SHIELDED COUPLINGS

Medium Duty No-Hub



The distinctive yellow shield quickly identifies the Medium-Duty MD Couplings and makes it easier for inspectors. 5/16" hex-head screw applies 80 in.-lbs. of installation torque to the band/shield assembly.

Medium Duty No-Hub Couplings conform to CISPI 310, Factory Mutual CN 1680. Couplings comply with ASTM C564, ASTM C1540, IAPMO file #3198, Commonwealth of Massachusetts CMR-248 and City of New York MEA 253-98-E. Gaskets are made from an elastomeric compound that meets the requirements of ASTM C564.

PART NUMBER	SIZE	CLAMPS PER COUPLING	INSTALL TORQUE (inch pounds)
MD-150	1-1/2"	4	80
MD-22	2"	4	80
MD-33	3"	4	80
MD-44	4"	4	80
MD-55	5"	6	80
MD-66	6"	6	80
MD-88	8"	6	80
MD-1010	10"	6	80

Heavy Duty No-Hub



The distinctive green shield quickly identifies the Heavy-Duty HD Couplings and makes it easier for inspectors. 3/8" hex-head screw applies 80 in.-lbs. of installation torque to the band/shield assembly. Boasts an ultimate torque rating exceeding 100 in.-lbs. and heavier gauge stainless steel.

Heavy Duty No-Hub Couplings conform to CISPI 310, Factory Mutual EN 1680. Couplings comply with ASTM C564, ASTM 1277, IAPMO file #3198, Commonwealth of Massachusetts CMR-248 and City of New York MEA 253-98-E. Gaskets are made from an elastomeric compound that meets the requirements of ASTM C564.

PART NUMBER	SIZE	CLAMPS PER COUPLING	INSTALL TORQUE (inch pounds)
HD-150	1-1/2"	4	80
HD-22	2"	4	80
HD-33	3"	4	80
HD-44	4"	4	80
HD-55	5"	6	80
HD-66	6"	6	80
HD-88	8"	6	80
HD-1010	10"	6	80



Concrete Manhole Adapters

Help eliminate leaks around pipes entering manhole walls.



CMA's are flexible enough to permit lateral pipe movement without destroying seal integrity. It is particularly useful for pipe to which concrete will not adhere, such as plastic pipe.

The CMA is made of elastomeric PVC, is corrosion proof and is unaffected by acid or alkali, however the CMA is subjected to many various conditions that are beyond the manufacturers control. High ground water tables, quality of grout, workmanship and field conditions can affect its ability to seal. Discretion must be used in its application and installation.

Part No.	Description
4 CMA	4" (101mm) I.D. Pipe
6 CMA	6" (152mm) I.D. Pipe
8 CMA	8" (203mm) I.D. Pipe
10 CMA	10" (254mm) I.D. Pipe
12 CMA	12" (304mm) I.D. Pipe

Due to the many varying factors that can influence the CMA's effectiveness as a seal, Fernco does not warrant this product as a positive water seal.

Large Diameter CMA's

For sewer pipe that is 8" and larger.



LDCMA's are flexible enough to permit lateral pipe movement without destroying seal integrity. It is particularly useful for pipe to which concrete will not adhere, such as plastic pipe.

The LDCMA is made of elastomeric PVC, is corrosion proof and is unaffected by acid or alkali, however the LDCMA is subjected to many various conditions that are beyond the manufacturers control. High ground water tables, quality of grout, workmanship and field conditions can affect its ability to seal. Discretion must be used in its application and installation.

Order by specifying the outside diameter (O.D.) of the pipe which is to receive the waterstop. Minimum size: 8.5 inches O.D. (55.6mm O.D.)

Due to the many varying factors that can influence the LDCMA effectiveness as a seal, Fernco does not warrant this product as a positive water seal.





Fernco Donuts

Sewer pipe compression joint seal.



Fernco Donuts are flexible PVC donut-shaped rings for the compression sealing of sewer pipe joints and DWV connections such as sockets, hubs, bells and spigots. They offer all of the properties necessary to create a strong, lasting joint.

Fernco Donuts are available in hundreds of sizes and configurations for use with most brands and types of piping material.

How To Order

Donuts can be ordered by giving the size, material and type of connection you want to make. Donuts require specific information on the manufacturer of pipe. Our sales coordinators are trained to assist you.

Donuts can also be ordered by dimensions. Donuts seal by compression and have much less dimensional range than couplings. The bell, hub or socket dimensions must be given within 1/32" accuracy.

For plain end pipe connections, use a Fernco Flexible Coupling - Listed on pages 14-15.



DONUTS / O-RINGS



Just give us a call.
Our sales coordinators are trained to assist you in making the right part selection.

United States
PH: 810-503-9000
FX: 810-503-1015



www.fernco.com

Canada
PH: 519-332-6711
FX: 519-332-8610



Multi-Tite Pipe Gaskets

Pipe gasket for service weight cast iron pipe.



SVG TECHNICAL SPECS

- Meets ASTM C564
- Multi rings on the outside make this gasket the easiest to install
- CARTON QUANTITIES ONLY



Part No.	Description
SVG-2	2" service weight cast iron
SVG-3	3" service weight cast iron
SVG-4	4" service weight cast iron
SVG-5	5" service weight cast iron
SVG-6	6" service weight cast iron
SVG-8	8" service weight cast iron
SVG-10	10" service weight cast iron
SVG-12	12" service weight cast iron
SVG-15	15" service weight cast iron

O-Rings



For connecting most 4" house pipe to 6" sewer pipe.



O-Rings provide a quick, simple means of making secure connections between most 4" house pipe and 6" sewer pipe.

Rolling Style Rubber O-Ring

Part No.	Description
BR-64	6" sewer pipe to 4" house pipe

BR TECHNICAL SPECS

- Meets ASTM C 443 and C 425
- Accepted for use in connecting CI or plastic house pipe to clay, plastic, concrete or A/C sewer pipe

Installs Quickly And Easily

For 4.20 Thru 4.60 O.D. House Pipe
Fits 5.75 To 6.00 I.D. Sewer Pipe

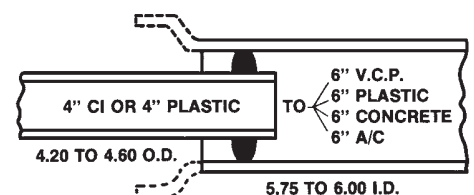



Qwik Caps / Hose Bibbs

Quick, reusable caps for pipe ends, testing & cleanouts.

Qwik Caps offer a quick, easy way to cap pipe ends, cleanouts and open test pipes. Made of flexible PVC, they're suitable for above-ground or underground use, on cast iron, steel, copper or plastic piping. The convex face allows the cap to withstand greater pressure for testing purposes and minimizes ballooning. To install, simply place over open end of pipe and tighten to 60" lbs. torque.



Qwik Caps

Part No.	Nominal Pipe Size
QC-101	1-1/2" (38mm)
QC-102	2" (50mm)
QC-103	3" (76mm)
QC-104	4" (101mm)
QC-105	5" (127mm)
QC-106	6" (152mm)
QC-108	8" (203mm)
TC-10	10" (254mm)
QC-112	12" (305mm)



QC TECHNICAL SPECS

- Fast, easy installation.
- Permanent or temporary cap.
- Underground or above-ground.
- Low cost and reusable.

Hose Bibbs

Part No.	Nominal Pipe Size
HBC-1	1-1/2" (38mm)
HBC-2	2" (50mm)
HBC-3	3" (76mm)
HBC-4	4" (101mm)

Water Well Debris Traps



Prevents loose debris from plugging pump suction area.

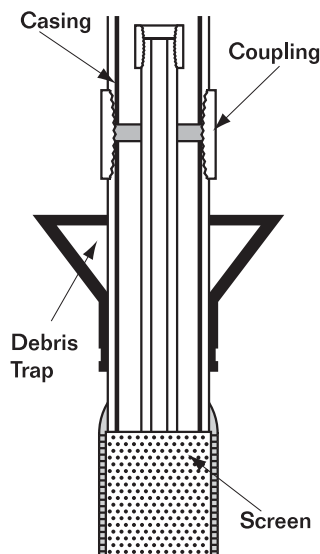

Debris Traps eliminate the common problem of loose dirt and stones plugging the pump suction area in water wells. The trap is quickly and easily installed over the well casing and secured with stainless steel clamp. Made of soft flexible PVC which conforms to irregularities of the drilled well. Does not crack or become brittle with age.



Part No.	Description
WC 500-238	2" casing x 5" well
WC 600-350	3" casing x 6" well
WC 600-450	4" casing x 6" well
WC 700-450	4" casing x 7" well
WC 700-562	5" casing x 7" well
WC 800-550	5" casing x 8" well
WC 900-550	5" casing x 9" well
WC 800-662	6" casing x 8" well
WC 1000-662	6" casing x 10" well

United States
PH: 810-503-9000
FX: 810-503-1015



www.fernco.com

Canada
PH: 519-332-6711
FX: 519-332-8610

Flexible Qwik Traps

The easy way to replace plastic or metal drain traps.



There's no faster, easier way to replace 1-1/4" or 1-1/2" (32 or 38mm) plastic or metal drain traps than with Fernco's Qwik Trap. Its flexible PVC material adjusts to pipe misalignment and it installs quickly and securely with a common screwdriver or nutdriver. QwikTrap provides a long-lasting, leak free connection that resists freeze damage, making it perfect for vacation homes. Just give it a squeeze to clean, with no drain tools or drain cleaners needed.



Packaged for counter display with complete application and installation instructions.

Part No.	Description
FT-150	1-1/4" or 1-1/2" drain trap

Drain & Trap Connectors



Connect tubular traps to common household drain pipe.

Drain & Trap Connectors are ideal for new installation, repairs and alterations. They can be installed quickly and easily without special tools, gluing, threading or soldering. Simply place the ends over the pipes and tighten the rustproof clamps.

The DTC-150 size connects 1-1/4" or 1-1/2" tubular traps to all common 1-1/4" or 1-1/2" drain piping. The DTC-215 size connects 1-1/4" or 1-1/2" tubular traps to all common 2" drain piping, except copper. (For 2" copper, use DTC-150.)



Packaged for counter display with complete application and installation instructions.



Part No.	Description
DTC-150	1-1/2" x 1-1/2" or 1-1/4" (38mm x 38mm or 32mm)
DTC-215	2" x 1-1/2" or 1-1/4" (50mm x 38mm or 32mm)





Tubular Drain Pipe Connector

For any combination of 1½" or 1¼" tubular drain pipe.



Fernco Tubular Drain Pipe Connectors offer a quick, easy way to extend, alter or repair any combination of 1-1/2" or 1-1/4" (32 or 38mm) brass or plastic drain pipe. Whether you're connecting brass to brass, plastic to plastic, or brass to plastic, you get an economical, leak free seal. Installation is fast and simple. The flexible elastomeric PVC material is formulated for drain use and provides a strong, reliable connection that's made in minutes, but lasts for years.

← Can be cut shorter for limited space pipe connections.



Packaged for counter display with complete application and installation instructions.

Part No.	Description
TC-150	1-1/4" or 1-1/2" (32 or 38mm) tubular drain pipe

Dishwasher Drain Connector



Connect dishwasher hose to sink drain or garbage disposer.



← Can be cut for different size pipe and hose applications of 1/2" or 3/4".

Dishwasher Drain Connector is a quick, simple way to connect a dishwasher hose to sink drains and garbage disposers. The strong elastomeric PVC material is engineered for years of leak free, trouble-free service.



Packaged for counter display with complete application and installation instructions.

Part No.	Description
DWC-100	Connects dishwasher hose to sink drain or garbage disposer - 1/2" x 3/4" (13mm x 19mm)

United States
PH: 810-503-9000
FX: 810-503-1015



www.fernco.com

Canada
PH: 519-332-6711
FX: 519-332-8610



Shower Drain Connectors

Connect 2" drain pipe to shower drain bodies.

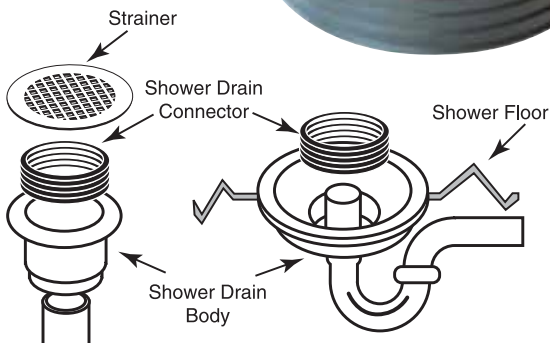

Shower Drain Connectors connect 2" DWV plastic, Sch. 40, steel or X.H. (extra-heavy) cast iron pipe to shower drain bodies. They reduce the time and cost of installation because no special tools, gluing, threading or lead caulking are required.

Part No.	Shower Drain Body
SD-200	American Brass & Aluminum
SD-200	Armstrong - requires cutting to 3/4" height)
SD-200	Casper-Model 101-101P
SD-200	Casper-Model 101 BR
SD-200	Garvin Model 475
SD-200	Intercon
SD-200	Kohler
SD-210	Mustee 1-piece molded shower base
SD-210	Owens Corning 1-piece molded shower base
SD-200	Schau Mfg. Brass Model 1524

Fix-A-Flange



For the repair of broken toilet flanges.



FIX-A-FLANGE eliminates the need to replace broken toilet flanges, saving time and money. Simply place the flange under the broken area of the ring and tighten the nut.



Packaged for counter display
with complete application and
installation instructions.

- Repairs broken toilet flanges without costly replacement
- Suitable for all cast iron, plastic, copper & brass toilet flanges
- Stops wobbly, leaking toilets
- Installs fast & easy

Part No.	Description
SF-100	Fix-A-Flange toilet flange repair

United States
PH: 810-503-9000
FX: 810-503-1015



www.fernco.com

Canada
PH: 519-332-6711
FX: 519-332-8610



Utility Connectors

Connect small drain lines to 1-1/2" DWV Plastic Socket.



These one piece connectors are designed for quick, easy connections. With a simple press fit (no tools needed) they connect 1", 3/4" or 1/2" CPVC and copper pipe to 1-1/2" DWV Schedule 40 plastic sockets (ABS or PVC).



Part No.	Description
UC-1550	1/2" CPVC or Copper to 1-1/2" DWV plastic socket
UC-1575	3/4" CPVC or Copper to 1-1/2" DWV plastic socket
UC-1510	1" CPVC or Copper to 1-1/2" DWV plastic socket

PLEASE NOTE: The utility connector is engineered to function in limited low-pressure application (5 PSI or 12 ft. head). **DO NOT USE in pressure water systems.** For pressures exceeding 5 PSI or 12 ft. head, but not greater than 11 PSI or 25 ft. head, the use of appropriate solvent cement, applied to the fitting socket and the utility connector, is recommended.

Hose Grip Clothes Washer Connector

Prevents accidental washer hose spills.



Holds washing machine hoses securely in their standpipe drains. Loose washer hoses have the tendency to "pull" themselves out of the laundry standpipe and spew water all over the floor.

Fits both 2" and 1-1/2" standpipes and most washing machine hoses from 1" to 1-7/16" diameters. Made from strong, flexible PVC for years of trouble-free use.



The Hose Grip has 4 vents to allow for air flow during discharge from the washer.

Part No.	Description
HG-1	Fits 2" or 1-1/2" standpipe, to 1" through 1-7/16" washer hose

United States
PH: 810-503-9000
FX: 810-503-1015



www.fernco.com

Canada
PH: 519-332-6711
FX: 519-332-8610



Downspout Connectors

Seals out problem causing debris and pests.



Fernco Flexible Downspout Connectors stretch easily over most common downspouts and drain pipes to seal out problem-causing debris and pests. Installation is fast and simple. For use with aluminum, steel or plastic downspouts and cast iron, spiral, corrugated or plastic drain pipe.

Part No.	Drain Pipe Size	Downspout
DSC-43	4" (101mm)	3" x 2" (76 x 50mm) rectangular OR
DSC-33	3" (76mm)	3" (76mm) round OR 2-1/2" (63.5mm) square
DSC-534	4" (101mm)	5" x 3" rectangular

Universal Downspout Connectors

For the connection of standard and non-standard downspouts.



The unique design of Fernco's Universal Downspout Connector allows for the easy connection of standard and non-standard downspouts to 6" sewer pipe and even allow for offset installations.

UDSC-6C 6" Cap

- Fits the OD of PVC and Cast Iron **ONLY**.
- For DWV pipe exposed above ground.
- For ANY downspout with a diagonal measurement of 6" or less.



UDSC-6P 6" Plug

- Fits in ANY 6" ID sewer pipe.
- For DWV pipe cut off at grade level.
- For ANY downspout with a diagonal measurement of 5.75" or less.

UDSC TECHNICAL SPECS

- Commercial or Residential
- NO Shrinking or Cracking
- NO Infiltration
- Positive Seal
- Rot and Root Proof
- Allows Offset Installation
- Simple trace and cut installation

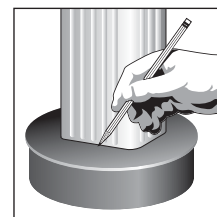



Sump Pump Check Valves

Reduces sump pump wear and tear.



Flexible couplings can be flipped over to fit 1-1/4" OR 1-1/2" drain pipe on CV-125T, CV-150T and CV-150 models.

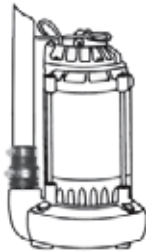
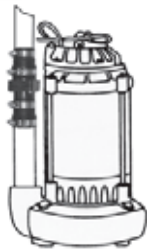

Fernco check valves allow for the unrestricted flow of water up and out through the pipes, but when the pump turns off, the water in the pipes doesn't flow backwards back into the sump pit causing more work and wear on the sump pump.

CV TECHNICAL SPECS

- Installs with Fernco flexible couplings for fast and easy installation
- Full flow positive sealing flapper design
- Heavy duty for long life
- Eliminates backflow and wear on pump
- Durable thermoplastic body

Part No.	Description
CV-125T	1-1/4" male pipe thread x 1-1/2" or 1-1/4"
CV-150T	1-1/2" male pipe thread x 1-1/2" or 1-1/4"
CV-150	1-1/4" or 1-1/2" x 1-1/4" or 1-1/2"
CV-200	2" x 2"

Torque Wrenches

For 5/16" hex head screws



TW-100 5/16" Ratchet Torque Wrench

Built in reversing lever is preset to 60 in. lbs. torque. Recommended for Fernco Couplings and other banded Fernco products. It has a chrome plated shank, with all metal construction.



TW-200 5/16" Ratchet Torque Wrench

Finger grip reversing collar is preset to 60 in. lbs. torque. Recommended for Fernco Couplings and other banded Fernco products. It has a chrome plated shank, with all metal construction.



Plumbing Market Sales Reps

1. David Gooding, Inc.
Brockton, MA
(508) 894-2000
ME, NH, VT, MA, RI, CT

2. Empire State Associates
Ballston Spa, NY
(518) 602-0271
New York State

3. Altherm, Inc.
Englewood, NJ
(201) 871-0500
New York City, Long Island,
Northern New Jersey

4. Rich-Tomkins Company, Inc.
Aston, PA
(610) 859-3552
E. PA, Southern NJ, DE

5. Fehr & Howard Sales, Inc.
Greensburg, PA
(724) 838-9394
West PA & WV

6. Lowder Sales
Lewis Center, OH
(800) 221-5650
OH

7. Lozuaway & Associates
Grand Blanc, MI
(810) 234-1635
MI, Lower MI

8. Ashworth—Train Assoc.
Indianapolis, IN
(317) 722-1950
IN

9. Kast Marketing, Inc.
Bensonville, IL
(630) 227-0600
N. IL

10. McCullough & Associates
Edina, MN
(952) 946-0126
MN, WI, ND, SD, Upper MI

11. Mankin & Associates
Earlham, IA
(515) 758-2956
IA, NE

12. Mack McClain & Associates
Olathe, KS
(913) 339-6677
KS, W. MO

13. T.M. Sales
Denver, CO
(303) 375-1515
CO, MT, WY,

14. McGregor & Associates
West Jordan, UT
(801) 566-8225
UT, ID

15. Gordon & Associates
Vancouver, WA
(360) 566-1470
WA, OR, AK

16. RV/Kincaide & Assoc.
Benicia, CA
(707) 745-3655
N. CA & N. NV

17. Carrhill Company
City of Commerce, CA
(323) 724-6087
S. CA, HI

18. BC Sales
Goodyear, AZ
(623) 810-2334
AZ

19. Solomon Sales, Inc.
Henderson, NV
(702) 269-7493
Clark County, NV

20. Stan Roberts & Assoc., Inc.
Houston, TX
(713) 224-9845
South TX

Dallas, TX
(214) 637-2816
North TX

21. PSA
Little Rock, AR
(501) 312-8700
AR

22. OK! Sales
Broken Arrow, OK
(405) 794-5200
Tulsa, OK

23. Specialty Sales & Service
Chesterfield, MO
(636) 530-1992
S. IL & E. MO

24. Billingsley & Associates
Kenner, LA
(504) 602-8100
LA, MS

25. Wm. M. McClain Co, Inc.
Nashville, TN
(615) 226-9601
TN

26. Banks & Head Agency
Anniston, AL
(256) 235-9000
AL & Panhandle FL

27. United Sales Agency
Marietta, GA
(770) 514-7444
GA

28. Carr Company
Boca Raton, FL
(561) 997-0999
FL, except Panhandle

29. Smith And Stevenson
Charlotte, NC
(704) 525-3388
NC, SC

30. W. Jennings Griggs Sales Corp.
Virginia Beach, VA
(757) 490-1541
VA, D.C., MD

31. Pinnacle Marketing
Albuquerque, NM
(502) 345-2700
NM

32. Kemper Sales & Assoc.
Nicholasville, KY
(859) 881-8624
KY

PUERTO RICO

33. Inter American Builders Agencies
Carolina, PR
(787) 752-0200
Puerto Rico

MEXICO

34. Ardent Sales
Long Beach, CA
(562) 552-4169
Mexico

CANADA

40. Barclay Sales LTD.
Port Coquitlam, BC
(604) 945-1010

41. Spectrum Sales Agencies 1982 LTD.
Calgary, Alberta
(403) 255-8332

Edmonton, Alberta
(780) 486-2525

42. Jones Goodridge
Winnipeg, Manitoba
(204) 632-6221
Regina, Sask
(306) 530-9056

Saskatoon, Sask
(306) 933-4377

43. Showerline Sales LTD.
London, Ontario
(519) 657-2694

Waterloo, Ontario
(519) 885-1578

44. Armco Agencies LTD.
Mississauga, Ontario
(905) 238-8448

45. Pelco Sales
Carp, Ontario
(613) 256-5596

46. Northern Mechanical Sales
Garson, Ontario
(705) 693-2715

47. Agencies J. Pierre Sylvain, Inc.
Boucherville, Que.
(450) 655-9588

Quebec, PQ.
(418) 570-0703

48. NerohTek Sales
Windsor, N.S.
(902) 869-0103

49. Par Four Plumbing
St. Johns, N.F.
(709) 739-7177

United States

PH: 810-503-9000
FX: 810-503-1015



www.fernco.com

Canada

PH: 519-332-6711
FX: 519-332-8610

Plumbing Market Sales Reps

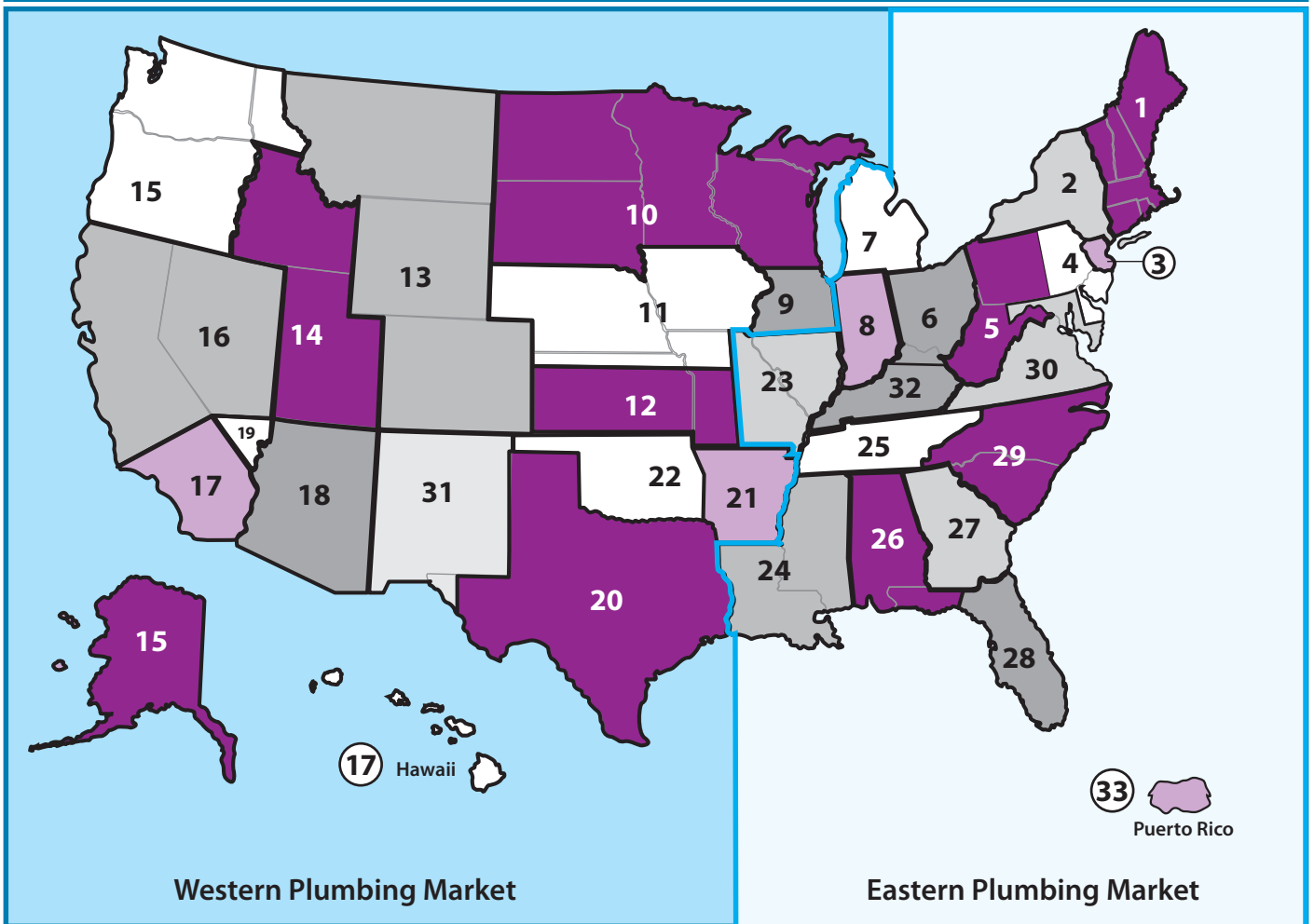
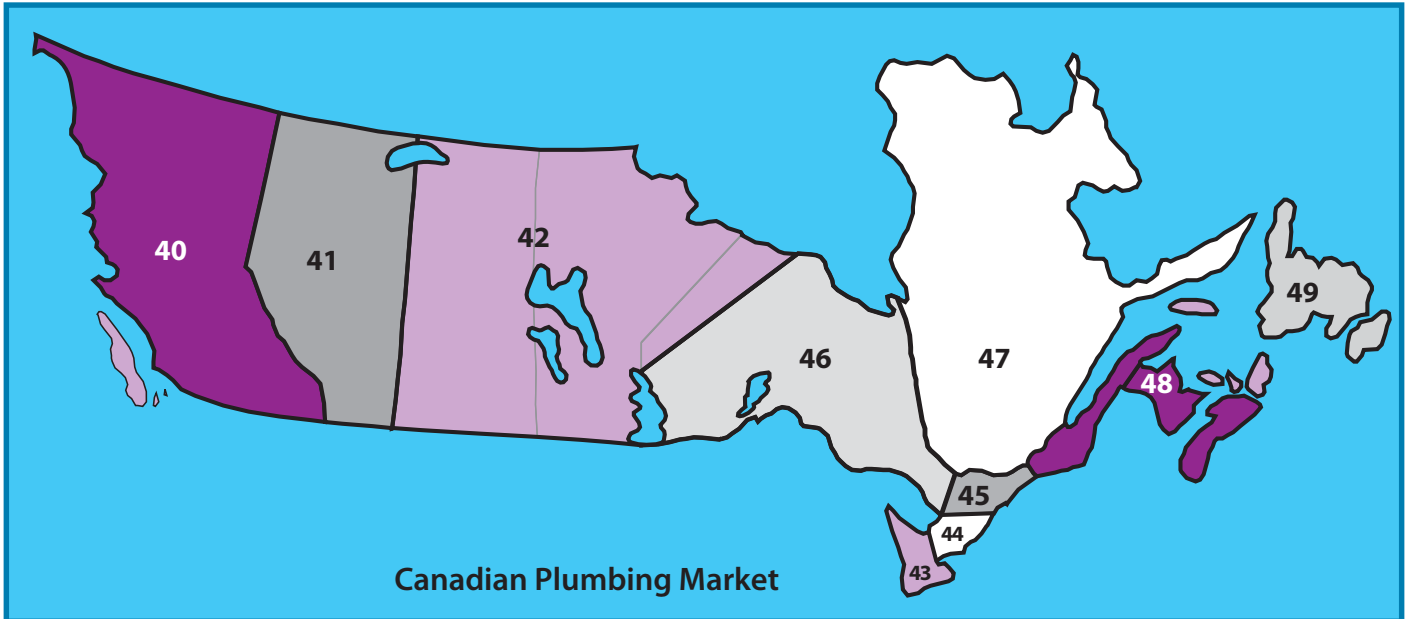

SALES REPS / CHARTS

Waterworks Market Sales Reps

1. David Gooding, Inc.
Brockton, MA
(508) 894-2000
ME, NH, VT, MA, RI, CT

2. Empire State Associates
Ballston Spa, NY
(518) 602-0271
New York State, Erie PA

3. Altherm, Inc.
Englewood, NJ
(201) 871-0500
New York City, Long Island
Northern New Jersey

4. Charles Morrow & Assoc.
Buckhannon, WV
(304) 472-9005
E. PA, S. NJ, DE,
VA, D.C., MD

5. Fehr & Howard Sales, Inc.
Greensburg, PA
(724) 838-9394
W. PA & WV

6. Hydrosource
Chagrin Falls, OH
(440) 247-9150
IN, OH

7. Lozuaway & Associates
Grand Blanc, MI
(810) 234-1635
Lower MI

8. Eaton Mechanical Sales
Prairie View, IL
(847) 980-7253
N. IL

9. Mack McClain & Associates
Olathe, KS
(913) 339-6677
KS, W. MO

St. Louis, MO
(314) 894-8188
S. IL, E. MO

10. Mankin & Associates
Earlham, IA
(515) 758-2956
IA, NE

11. McCullough & Associates
Eden Prairie, MN
(952) 946-0126
MN, WI, ND, SD, Upper MI

12. Repmasters, Inc.
Commerce City, CO
(303) 286-7575
CO, MT, WY

13. McGregor & Associates
West Jordan, UT
(801) 566-8225
UT, ID

14. Gordon & Associates
Vancouver, WA
(360) 566-1470
WA, OR, AK

15. RV/Kincaide & Assoc.
Benicia, CA
(707) 745-3655
N. CA & N. NV

16. Stan Roberts & Assoc., Inc.
Houston, TX
(713) 224-9845
South TX, except El Paso, TX

Dallas, TX
(214) 637-2816
North TX

17. PSA
Little Rock, AR
(501) 312-8700
AR

18. OK! Sales
Broken Arrow, OK
(405) 794-5200
OK

19. Billingsley & Associates
Kenner, LA
(504) 602-8100
LA, MS

20. Wm. M. McClain Co, Inc.
Nashville, TN
(615) 226-9601
TN

21. Banks & Head Agency
Anniston, AL
(256) 235-9000
AL

22. Buchanan Sales
Kennesaw, GA
(770) 425-6028
GA

23. L.J. Ruffin & Associates
Orlando, FL
(407) 291-2341
FL

24. Ultratech Water Resources
Shelby, NC
(704) 445-0220
NC, SC

25. Pinnacle Marketing
Albuquerque, NM
(502) 345-2700
NM, El Paso, TX

26. Kemper Sales & Assoc.
Nicholasville, KY
(859) 881-8624
KY

27. Solomon Sales, Inc.
Henderson, NV
(702) 269-7493
Clark County, NV

28. Mainline Sales, Inc.
Anaheim, CA
(877) 300-9346
S. CA, HI

Phoenix, AZ
(888)304-3219
AZ

PUERTO RICO

29. Inter American Builders Agencies
Carolina, PR
(787) 752-0200
Puerto Rico

MEXICO

30. Ardent Sales
Long Beach, CA
(562) 552-4169
Mexico

CANADA

40. Barclay Sales LTD.
Port Coquitlam, BC
(604) 945-1010

41. Spectrum Sales Agencies 1982 LTD.
Calgary, Alberta
(403) 255-8332

Edmonton, Alberta
(780) 486-2525

42. Jones Goodridge
Winnipeg, Manitoba
(204) 632-6221

Regina, Sask
(306) 530-9056

Saskatoon, Sask
(306) 933-4377

43. Showerline Sales LTD.
London, Ontario
(519) 657-2694

Waterloo, Ontario
(519) 885-1578

44. Armco Agencies LTD.
Mississauga, Ontario
(905) 238-8448

45. Pelco Sales
Carp, Ontario
(613) 256-5596

46. Northern Mechanical Sales
Garson, Ontario
(705) 693-2715

47. Agencies J. Pierre Sylvain, Inc.
Boucherville, Que.
(450) 655-9588

Quebec, PQ.
(418) 570-0703

48. NerohTek Sales
Windsor, N.S.
(902) 869-0103

49. Par Four Plumbing
St. Johns, N.F.
(709) 739-7177

United States

PH: 810-503-9000
FX: 810-503-1015



www.fernco.com

Canada

PH: 519-332-6711
FX: 519-332-8610

Waterworks Market Sales Reps

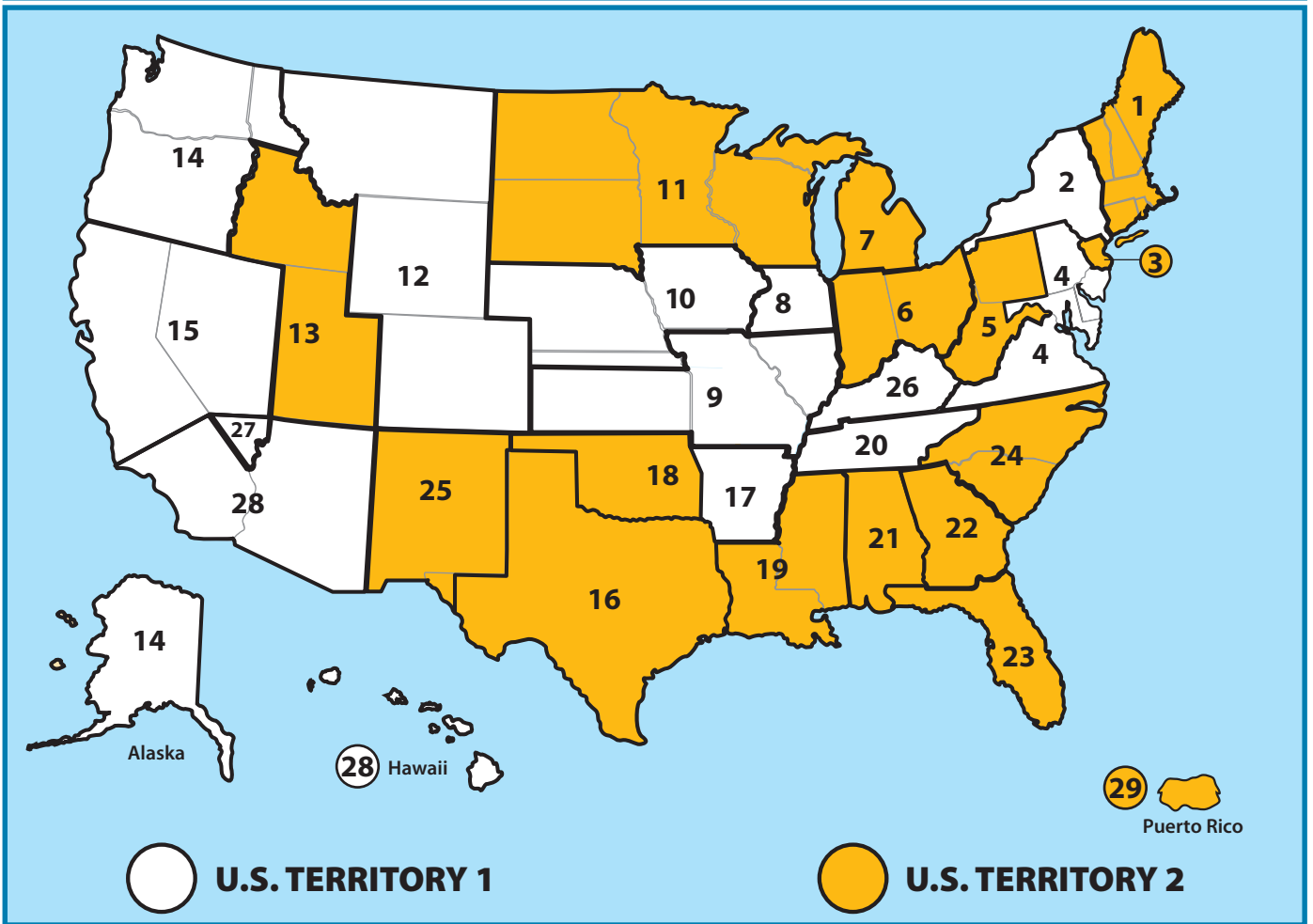
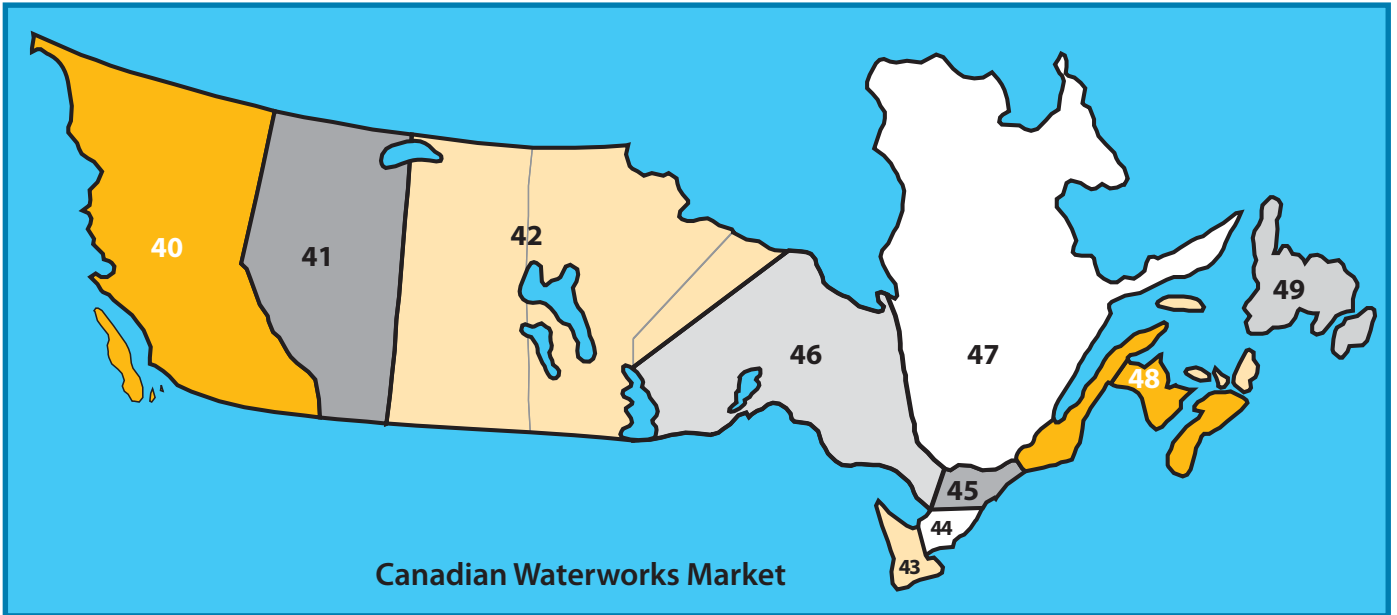

SALES REPS / CHARTS

Acid Resistance Chart

Maximum test pressure: 4.3 PSI (29.6 KPA)

Maximum operating temperature: 140° F nonconsistent

R—Recommended N—Not Recommended

Reagent	Flexible Coupling 70°F	Proflex 70°F	Reagent	Flexible Coupling 70°F	Proflex 70°F	Reagent	Flexible Coupling 70°F	Proflex 70°F
Acetic Acid 20%	R	R	Disodium Phosphate	N	N	Silver Cyanide	R	R
Acetic Acid 80%	N	N	Distilled Water	R	R	Silver Nitrate	R	R
Acetone	N	N	Ethers	N	N	Silver Sulfate	R	R
Alcohol (Methyl or Ethyl)	R	R	Ethyl Acetate	N	N	Sodium Bicarbonate	R	R
Aluminum Chloride	R	R	Ethylene Chloride	N	N	Sodium Bisulfite	R	R
Aluminum Sulfate	R	R	Ethylene Glycol	R	R	Sodium Carbonate	R	R
Alums	R	R	Fatty Acids (C6)	R	R	Sodium Cyanide	R	R
Ammonia Gas (Dry)	R	R	Ferric Chloride	R	R	Sodium Ferrocyanide	R	R
Ammonium Chloride	R	R	Ferric Sulfate	R	R	Sodium Hydroxide	R	R
Ammonium Hydroxide	R	R	Fluorine (Gas Wet)	N	N	Sodium Hypochlorite	R	N
Ammonium Nitrate	R	R	Formaldehyde (20%)	R	R	Sodium Sulfate	R	R
Ammonium Phosphate	R	R	Formic Acid (10%)	R	R	Sodium Sulfide	R	R
Ammonium Sulfate	R	R	Freon 12 Dry	N	R	Sodium Sulfite	R	R
Ammonium Sulfide	R	R	Fruit Juices & Pulp	R	R	Sodium Thiosulfate	R	N
Amyl Chloride	N	N	Furfural	N	N	Stannic Chloride	R	N
Aniline	N	N	Gasoline (Refined)	N	N	Stannous Chloride	R	R
Aqua Regia	N	N	Glucose	R	R	Stearic Acid	R	R
Barium Chloride	R	R	Glycerine	R	R	Sulfite Liquor	R	R
Barium Hydroxide	R	R	Hydrobromic Acid (20%)	R	N	Sulfur	R	N
Barium Sulfate	R	R	Hydrochloric Acid	R	N	Sulfur Dioxide (Dry)	R	N
Barium Sulfide	R	R	Hydrocyanic Acid	R	R	Sulfur Dioxide (Wet)	R	N
Beer	R	R	Hydroquinone	R	N	Sulfuric Acid 50%	R	R
Beet Sugar Liquors	R	R	Hypochlorous Acid	R	N	Sulfuric Acid 70%	N	N
Benzene	N	N	Iodine	N	N	Sulfuric Acid 93%	N	N
Benzoic Acid	R	N	Kerosene	N	N	Sulfurous Acid	R	N
Black Liquor	R	R	Lactic Acid 25%	R	R	Tannic Acid	R	R
Bleach 12 5% active Cl ₂	R	N	Linseed Oil	R	R	Tanning Liquors	R	R
Boric Acid	R	R	Liquors	N	N	Tartaric Acid	R	R
Bromic Acid	R	N	Machine Oil	N	N	Toluene	N	N
Bromine Water	N	N	Magnesium Chloride	R	R	Trichloroethylene	N	N
Butane	N	R	Magnesium Sulfate	R	R	Triethanolamine	N	N
Butyric Acid	N	N	Maleic Acid	N	N	Trisodium Phosphate	R	R
Calcium Carbonate	R	R	Methyl Chloride	N	N	Turpentine	N	N
Calcium Chloride	R	R	Methyl Ethyl Ketone	N	N	Urea	R	R
Calcium Hydroxide	R	R	Milk	R	R	Urine	R	R
Calcium Hypochlorite	R	N	Mineral Oils	N	R	Vinegar	R	R
Calcium Sulfate	R	R	Muriatic Acid	R	N	Water (Fresh)	R	R
Cane Sugar Liquors	R	R	Nickel Chloride	R	R	Water (Salt)	R	R
Carbon Bisulfide	N	N	Nickel Sulfate	R	R	Whiskey	R	R
Carbon Dioxide	R	R	Nitric Acid 0-40%	R	N	Wines	R	R
Carbon Monoxide	R	R	Nitric Acid 41-100%	N	N	Xylene	N	N
Carbon Tetrachloride	N	N	Oleic Acid	N	N	Zinc Chloride	R	R
Carbon Acid	R	R	Oleum	N	N	Zinc Sulfate	R	R
Caustic Soda	R	N	Oxalic Acid	R	R			
Caustic Soda 50%	R	R	Palmitic Acid 10%	R	R			
Caustic Potash	R	R	Perchloric Acid	N	N			
Chloride (Dry)	N	N	Petroleum Oils (Sour)	N	N			
Chloride (Wet)	N	N	Phenol 5%	N	N			
Chloroacetic Acid	N	N	Phosphorous Trichloride	N	N			
Chlorobenzene	N	N	Photographic Solutions	R	R			
Chloroform	N	N	Picric Acid	N	N			
Chromic Acid 10%	R	N	Plating Solution	R	R			
Chromic Acid 50%	N	N	Potassium Carbonate	R	R			
Citric Acid	R	R	Potassium Chlorate	R	R			
Copper Chloride	R	R	Potassium Chloride	R	R			
Copper Cyanide	R	R	Potassium Cyanide	R	R			
Copper Nitrate	R	R	Potassium Dichromate	R	R			
Copper Sulfate	R	R	Potassium Hydroxide	R	R			
Cottonseed Oil	R	R	Potassium Permanganate 10%	R	R			
Cresol	N	N	Potassium Sulfate	R	R			
Cyclohexanol	N	R	Propane Gas	R	R			
Cyclohexanone	N	N	Propyl Alcohol	R	R			
Dimethylamine	N	N	Sea Water	R	R			
Diocyl Pthalate	N	N	Sewerage	R	R			

NOTE: The data listed in this table is only to give information in regard to general use and does not constitute a guarantee. Materials should be tested under actual service to determine suitability for a particular purpose.

United States

PH: 810-503-9000
FX: 810-503-1015



www.fernco.com

Canada

PH: 519-332-6711
FX: 519-332-8610

TERMS

All prices shown are Trade/List, stated in U.S. currency and subject to change without notice.

MINIMUM INVOICE - None

PAYMENT TERMS - 1% 10th prox. NET 30 days unless otherwise stated. Shortage claim must be made to Fernco within 15 days after delivery.

FREIGHT TERMS - Prepaid and allowed on net orders of \$750.00 or more unless otherwise stated. All others will be prepaid and billed. Claims for loss or damage must be filed with the freight carrier.

SALES POLICY - Fernco products are available to any legitimate wholesaler, pipe manufacturer or distributor with approved credit.

RETURN POLICY - All returns must be preceded by factory authorization.

Minimum 15% restocking charge will apply to all standard Fernco products. All materials returned to Fernco should be in original cartons and be in resalable condition. This amount is subject to change depending on condition of items returned to Fernco.

- Fernco Custom Parts are Non-Returnable.
- Freight must be prepaid on all return shipments.
- Returns will not be allowed after 90 days of invoice date.

LIMITED WARRANTY

Fernco warrants its product(s) against defects in workmanship or materials for one (1) year from date of original purchase (unless a shorter period is expressly provided with respect to a particular product). Fernco's total liability under any warranty, or any other claim arising in any way from the product or its use, is limited, at Fernco's option, to refund or replacement of any such product returned to Fernco within the one-year warranty period and determined by Fernco to be defective. To the extent permitted by law, Fernco disclaims and excludes any and all other warranties, express or implied, including without limitation any implied warranty of merchantability or fitness for a particular purpose, and in no event shall Fernco be liable for special, incidental or consequential damages. Failure to follow the installation instructions provided by Fernco will void this warranty. To make a warranty claim, purchaser should have the original receipt and contact Fernco, Inc. Customer Service Department, 810 503-9000. Purchaser is responsible for any shipping charges.

If state law preserves implied warranties, including implied warranties of merchantability and fitness for a particular purpose, such warranties are limited to one-year from the date of the original purchase and as otherwise set forth above. Some states do not allow limitations on how long an implied warranty lasts, or the exclusion of incidental or consequential damages, so such limitation(s) or exclusion(s) may not apply to you.

This written warranty gives you specific legal rights, and you may also have other rights which vary from state to state.

Fernco, Inc.

300 S. Dayton St.
Davison, MI 48423
www.fernco.com
P: (810) 503-9000
F: (810) 503-1015

Fernco West

855 Linda Way
Sparks, NV 89431
www.fernco.com
P: (810) 503-9000
F: (810) 503-1015

Fernco Connectors LTD

850 Phillip Street E.
Sarnia, Ontario N7T 1Z6
www.ferncoconnectors.ca
P: (519) 332-6711
F: (519) 332-8610



www.fernco.com

We support recycling. 

CONNECT

ADAPT

REDUCE

CAP



CAP TAP REDUCE

CAP TAP SEAL



www.fernco.com

