



Reeves-Wiedeman Company
 PLUMBING SUPPLIES FOR CONTRACTORS AND INDUSTRY



DELTA-Delta Faucets
 RW List Prices - Page P-1



See what Delta can do

Delta Kitchen Faucet Collections



Classic Series



Collins Series



Core-B Series



Waterfall Series



Leland Series



Signature Series



Saxony Series



Pilar Series

Reeves-Wiedeman Company

Emporia, Ks	Grandview, Mo	Independence, Mo	KCMO-Downtown	KCMO-Midtown	KCMO-Waldo	Lawrence, Ks	Junction City, Ks	Leavenworth, Ks
Liberty, Mo	Lees Summit, Mo	Lenexa, Ks	Manhattan, Ks	Maryville, Mo	Olathe, Ks	Riverside, Mo	Saint Joseph, Mo	Topeka, Ks

Shaded Items are Non-Stock

DELTA-Delta Faucets
Page P-2 - RW List Prices

B1310L Core-B Single Lever
B4410L Core-B Single Lever

- 9-1/2" long, 8 3/8" high spout
- 5-8" from deck to aerator
- Order RP19754 for 1.5 GPM aerator
- Standard spout swivels 360 degrees
- Washerless ball valve
- 2.2 gpm @ 60 psi, 8.3 L/min @ 414 kPa
- 4-hole 8" installation
- Solid brass fabricated body.
- 9 1/2"(241 mm) long., 6 5/8"(168 mm) high spout swings 360°.
- All operating parts replaceable from the top.
- 1/2"-14 NPSM threaded male inlet adapters.
- Control handle returns to neutral position when valve is turned off.
- spray attachment has antisiphon device as integral part of valve body

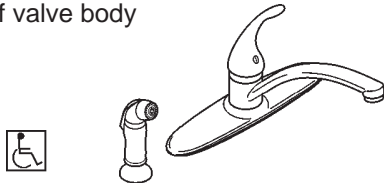

Part #	Description	Price
24803120	B1310LF Core CP Sink Faucet L/Spray	126.00
24803125	B4410LF Core CP Sink Faucet W/Spray	152.00

100-DST - Classic Single Lever
300-DST - Classic Single Lvr W/Spry in Body
400-DST - Classic Single Lever W/Spray

- 8" Long spout swings 360°
- 2.0 gpm @ 60 psi (7.6 L/min @ 414 kPa)
- 3 Hole Installation - 8" Centers

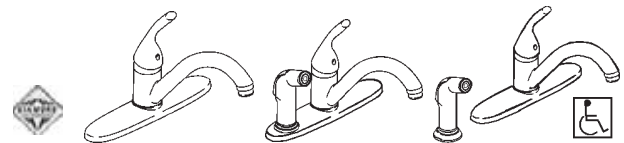

Part #	Description	Price
24803000	100-DST Classic S/L Sink Faucet L/Spray	136.00
24803005	300-DST Classic S/L Sink Fct W/Spr In Base	176.00
24803010	400-DST Classic S/L Sink Faucet W/Spray	170.00

101-DST - Classic Single Hole
175-DST - With Spray

- 8" Long spout swings 360°
- 2.0 gpm @ 60 psi (7.6 L/min @ 414 kPa)
- Single Hole Installation
- Available with or without spray



Part #	Description	Price
24803015	101-DST Classic S/L Sink Faucet L/Spray	140.00
24803020	175-DST Classic S/L Sink Faucet W/Spray	176.00



DELTA-Delta Faucets
RW List Prices - Page P-3

140-DST - Collins® Single Lever
340-DST - Collins® With Spray in Body
440-DST - Collins® With Spray

- 9" Long spout swings 360°
- Single lever handle
- Red/blue handle indicators
- Straight staggered supply tubes - 7-1/4" long
- 2.0 gpm @ 60 psi (7.6 L/min @ 414 kPa)
- 3 Hole Installation - 8" Centers

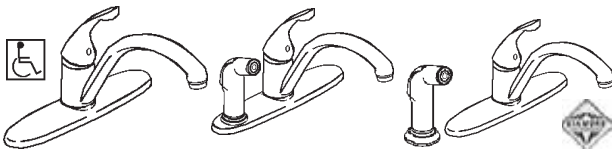

Part #	Description	Price
24803035	140-DST Collins S/L Sink Fct L/Spray	162.00
24803040	140-WH-DST Collins Wh S/L Sink Fct L/Spray	210.00
Part #	Description	Price
24803045	340-DST Collins S/L Sink Fct W/Spray	198.00
24803050	340-WH-DST Collins Wht S/L Sk Fct W/Spray	256.00
Part #	Description	Price
24800082	440-DST Collins S/L Sink Fct W/Spray	198.00
24803025	440-SS-DST Collins SS Sink Fct W/Spray	266.00

141-DST - Collins Single Hole
441-DST - With Spray

- 9" Long spout swings 360°
- Single lever handle
- Red/blue handle indicators
- Straight staggered supply tubes - 5-7/8" and 7-3/16" long
- 2.0 gpm @ 60 psi (7.6 L/min @ 414 kPa)



Part #	Description	Price
24803055	141-DST Collins S/L Sink Fct L/Spray	162.00
24803030	441-SS-DST Collins SS Sink Fct W/Spray	266.00

B4310LF Core-B With Pull-Out Spray

- 9-5/8" long, 10" high spout
- Optional 8" escutcheon included
- 59" long hose
- Optional 8" escutcheon included
- 8-3/4" long, 8-9/32" high pull-out spout swings 120° and operates in either spray or aerate mode

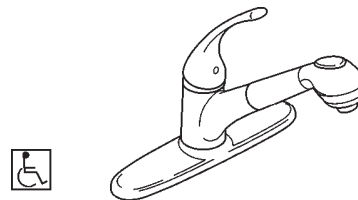

Part #	Description	Price
24803130	B4310F Core CP Sink Faucet W/Spray	224.00

DST Technology

Diamonds are the hardest substance known to man, and DIAMOND™ Seal Technology takes full advantage of this property. Delta's exclusive DIAMOND Seal Technology uses a valve with a tough diamond coating to bring you a faucet built to last up to 5 million uses – plus it keeps water inside the faucet out of contact with potential metal contaminants.

With its durable components and simple construction, a DIAMOND Seal Technology faucet lasts 10 times longer than the industry standard (ASME 112.18.1, 500,000 cycles). One-piece InnoFlex® waterways with PEX-C tubing make DIAMOND Seal Technology faucets simple to install.

The handle limit stop on Delta's DIAMOND™ Valve cartridge makes it easy to limit the range of the handle motion for hot water from full flow to a 50/50 mix. This feature is the smart choice to protect sensitive skin from scalding.

DELTA-Delta Faucets
Page P-4 - RW List Prices

978-DST Leland With Pull-Out Spray

- 14-1/4" high, 9-3/16" long, spout swings 360°.
- 2.2 gpm @ 60 psi, 8.3 L/min @ 414 kPa
- 2-hole 4" installation for exposed mounting on two and three hole sinks.
- Single handle, 2-function pull-down kitchen faucets
- MagnaTite® Docking
- Control returns to neutral position when faucet is turned off.
- Integral double check valves in sprayer assembly.
- 3/8" O.D. straight, staggered pex supply tubes - 36-3/4" and 37-3/4" long.
- Touch-Clean®



Part #	Description	Price
24803170	978-DST Leland CP Pulldown Sink Fct	378.00

Only Delta faucets are equipped with Touch-Clean® soft, rubber nubbins that allow you to easily wipe away calcium and lime build-up with the touch of a finger.

MagnaTite® docking keeps the kitchen pull-down spray wand firmly in place with a powerful integrated magnet, so it stays docked when not in use. The pull-down spray wand comes free with a gentle tug and gives you total flexibility. The hose extends and retracts without friction points, fed by gravity. The toggle button on most wands featuring MagnaTite allows you to switch between aerated spray and stream modes.

470 DST- Signature® With Pull-Out Spray

- 8" High, 9" Long spout swings 120° (Includes 6-1/4" Long Pull-Out Spray)
- Hose extends 38"
- Single lever handle
- Red/blue handle indicators
- 2.0 gpm @ 60 psi (7.6 L/min @ 414 kPa)
- 1 or 3 Hole Installation
- Includes Optional 10-3/4" Escutcheon
- DST-DIAMOND™
- Equipped with Touch-Clean®

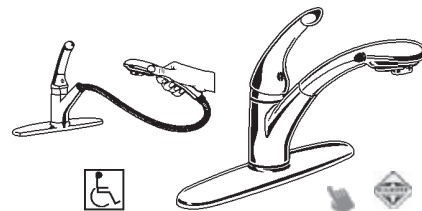

Part #	Description	Price
24830110	470-DST Sig, CP Pull Out Spray Sink Fct	346.00
24800830	470-AR-DST Sig, SS Pull Out Spry Sink Fct	482.00

4380-DST Pilar With Spray

- 10-1/2" long, 13" high spout swings 180°
- Single lever handle
- 3/8" O.D. straight, staggered pex supply tubes 35" and 36" long
- 2.2 gpm @ 60 psi, 8.3 L/min @ 414 kPa
- 3-hole 6-16" installation
- DST-DIAMOND™ Seal Technology

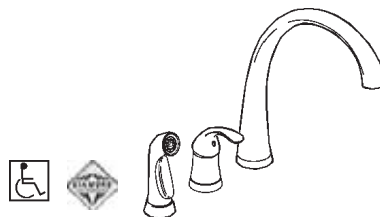

Part #	Description	Price
24803080	4380-DST Pilar S/H Sink Faucet W/Spray	388.00



**DELTA-Delta Faucets
RW List Prices - Page P-5**

**B2310LF Core-B Lever Handles
B2410LF Core-B Lever Handles w/Spray**

- Solid brass fabricated body
- 9-1/4" long, 6-7/16" high spout
- 5 1/4" from deck to aerator
- Standard spout swivels 360 degrees
- 4-hole 8" installation
- Lever handles with 1/4 turn stops.
- Hot and cold stems are interchangeable.
- Lever handle control mechanism is a rotating cylinder type with stainless steel plate and 90°rotating, with replaceable non-metallic seats
- 1/2" -14 NPSM threaded male inlet shanks.
- Spray attachment with antisiphon device as integral part of valve body.



Part #	Description	Price
24803140	B2310LF Core CP 2H Sink Fct L/Spray	102.00
24803145	B2410LF Core CP 2H Sink Fct W/Spray	124.00

**2100 - Basic Lever Two Handle
2400 - Basic Lever Two Handle W/ Spray**

- 8" Long spout swings 360°
- Red/blue handle indicators
- Blade handles
- Standard with 1/2" I.P.S. shanks
- 2.0 gpm @ 60 psi (7.6 L/min @ 414 kPa)
- 3 or 4 Hole Installation - 8" Centers



Part #	Description	Price
24810558	2100 Classic Blade 2H Sink Faucet L/Spray	104.00

**2102 - Basic Clear Knobs
2402 - Basic Clear Knobs With Spray**

- 8" Long spout swings 360°
- Red/blue handle indicator
- Clear Knob Handles
- Standard with 1/2" I.P.S. shanks
- 2.0 gpm @ 60 psi (7.6 L/min @ 414 kPa)
- 3 OR 4 Hole Installation - 8" Centers



Part #	Description	Price
24810566	2102 Classic Acrylic 2H Sink Faucet L/Spray	104.00
24810590	2402 Classic Acrylic 2H Sink Faucet W/Spray	130.00

DELTA-Delta Faucets
Page P-6 - RW List Prices

2176 2476 - Waterfall®

- 9-1/2" Long, 11-1/4" high spout swings 360°
- Standard with 1/2" I.P.S. shanks
- 2.0 gpm @ 60 psi (7.6 L/min @ 414 kPa)
- 3 Hole Installations

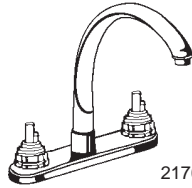

2176LHP

Uses: H24 A24
H25

LHP Faucets Require Handles and Accents for a Complete Faucet

Part #	Description	Price
24810615	2176-LHP Waterfall Sink Fct L/Spray	196.00
24810599	2476-LHP Waterfall Sink Fct W/Spray	242.00

EMPORIA	Dusty Smart, Manager 506 Funston St. Emporia, Ks 66801-4312 (620) 342-7121 Fax: (620) 342-7122	LEE'S SUMMIT	Todd McGraw, Manager 1053 SE Broadway Dr. Lee's Summit, MO 64081-4601 (816) 246-1600 Fax: (816) 246-1614
GRANDVIEW	Dave Burger, Manager 13421 S. 71 Highway Grandview, Mo 64030 (816) 763-5000 Fax: (816) 763-3204	LENEXA	Charles Lester, Manager Darren Brown, Counter Manager 14861 W. 100th Lenexa, KS 66215-1114 (913) 492-7100 Fax: (913) 492-6962
INDEPENDENCE	Gary Slocum, Manager 4324 S Washington. Independence, Mo 64055 (816) 373-5510 Fax: (816) 373-7959	LIBERTY	Cam McDole, Manager 1051 S Brown Liberty, MO 64068 (816) 781-1204 Fax: (816) 781-8124
JUNCTION CITY	Ramey Murrell, Manager 813 N Perry Junction City, Ks 66441 (785) 238-1500 Fax: (785) 238-6700	MANHATTAN	Marvin Deters, Manager 1100 Kretschmer Dr. Manhattan, KS 66502-5024 (785) 776-9271 Fax: (785) 776-2123
KANSAS CITY DOWNTOWN	Anthony Palermo, Manager 1350 E 13 St. Kansas City, MO 64106 (816) 221-2220 Fax: (816) 471-0966	MARYVILLE	Joetta Richardson, Manager 2406 Burns Rd. Maryville, Mo 64468 (660) 562-2040 Fax: (660) 562-3640
KANSAS CITY MIDTOWN	Rich Moreno, Manager 3635 Main St Kansas City, Mo 64111 (816) 531-4900 Fax: (816) 756-5249	OLATHE	Tom Rapue, Manager 19952 W 162 St. Olathe, KS 66062-2787 (913) 829-9090 Fax: (913) 829-7474
KANSAS CITY WALDO	JD Broockerd, Manager 8310 Wornall Rd Kansas City, Mo 64114 (816) 822-7900 Fax: (816) 361-5918	RIVERSIDE	Sharon Davis, Manager Ed Nelson, Outside Sales 4120 NW Riverside St. Riverside, MO 64150-9668 (816) 741-4660 Fax: (816) 741-0118
LAWRENCE	Dan Doherty, Manager 2420 W. 31st St. Lawrence, KS 66047-3175 (785) 841-5815 Fax: (785) 841-5040	ST. JOSEPH	Steve Hamilton, Manager 814 S. 22nd St. St. Joseph, MO 64507-1159 (816) 232-5469 Fax: (816) 279-2610
LEAVENWORTH	Kirk Quinley, Manager 5101 S. 13th St. Leavenworth, KS 66048-1999 (913) 727-9000 Fax: (913) 250-0048	TOPEKA	Jim Alderfer, Manager 1815 Western Topeka, KS 66604-1446 (785)234-6627 Fax: (785)234-4294



**DELTA-Delta Faucets
RW List Prices - Page P-7**

DELTA BAR AND UTILITY FAUCETS

2170 2172 - Bar Faucet

- 4" Long, 10-5/8" high spout swings 360°
- Standard with 1/2" I.P.S. shanks
- 2.0 gpm @ 80 psi (7.6 L/min @ 551 kPa)
- 2 Hole Installation, 4" centerset

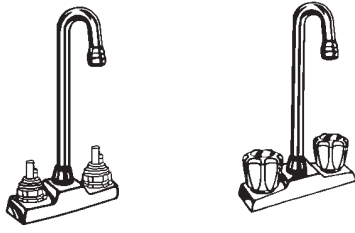

Uses: H25

2172-LHP

2170

LHP Faucets Require Handles and Accents for a Complete Faucet

Part #	Description	Price
24810600	2172LF-LHP Classic Bar Faucet L/Handle	150.00
24810608	2170LF Classic Acrylic Bar Sink Faucet	156.00

710WFHDF & 711WFHDF Utility Faucets

- 5-3/4" Long, 11" high gooseneck spout
- 710-WFHDF 5-3/4" Long, 11" High Rigid Gooseneck Spout
- 711-WFHDF 5-3/4" Long, 11" High Spout Swings 360°
- Vandal resistant handle(s)
- Red/blue handle indicators
- Non-vandal resistant spray outlet
- Stainless steel ball (Elbow handle only)
- 2.0 gpm @ 80 psi (7.6 L/min @ 551 kPa) laminar flow



710-WFHDF,



Part #	Description	Price
24810301	710LF-HDF Utility Faucet Rigid Spout	262.00
24810302	711LF-HDF Utility Faucet Swing Spout	278.00

2131 - Laundry Faucet

- 5-5/8" Long, 6-1/2" high spout swings 360°
- With nose thread
- Lever Two-Handle



2131



Part #	Description	Price
24810574	2131 Classic Laundry Faucet	86.00



Reeves-Wiedeman Company
PLUMBING SUPPLIES FOR CONTRACTORS AND INDUSTRY



DELTA-Delta Faucets
Page P-8 - RW List Prices

DELTA
See what Delta can do

Delta Bathroom Faucet Collections



Core-B Series



Classic Series



Leland Series



Innovations Series



Reeves-Wiedeman Company

Emporia, Ks	Grandview, Mo	Independence, Mo	KCMO-Downtown	KCMO-Midtown	KCMO-Waldo	Lawrence, Ks	Junction City, Ks	Leavenworth, Ks
Liberty, Mo	Lees Summit, Mo	Lenexa, Ks	Manhattan, Ks	Maryville, Mo	Olathe, Ks	Riverside, Mo	Saint Joseph, Mo	Topeka, Ks

Shaded Items are Non-Stock



DELTA-Delta Faucets
RW List Prices - Page P-9

501-DST - Classic Lav Faucet-Lever

- Classic Series
- DST-DIAMOND™ Seal Technology
- Single Handle Deck Mount
- 3 Hole Applications
- 4 Centerset
- 5" Long Spout



Part #	Description	Price
24806100	501-DST Classic S/L Lav Faucet Less Popup	142.00

B510LF Core-B Lav Faucet-Lever

- 4-1/4" long, 5-7/16" high spout
- 2-1/16" from deck to aerator
- Metal lever handle
- Metal pop-up
- 4" centerset.
- Control handle returns to neutral position when valve is turned off.
- Models have 1/4" O.D. copper supply tubes - 3 1/2" (89 mm) long with 1/2"-14 NPSM adapters.
- 1.5 gpm @ 60 psi, 5.7 L/min @ 414 kPa



Part #	Description	Price
24803135	B510LF Core CP Lav Faucet W/PU	146.00

B512LF Core-B Faucet-Knob

- 4-1/4" long, 5-7/16" high spout
- Clear knob handle
- Metal pop-up
- 1.5 gpm @ 60 psi, 5.7 L/min @ 414 kPa
- Control handle returns to neutral position when valve is turned off
- 4" centerset.

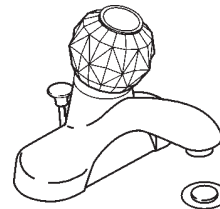

Part #	Description	Price
24803150	B512LF Core CP Lav Faucet W/PU	138.00

520-MPU-DST Classic Lav Faucet-Lever

- Classic Series
- DST-DIAMOND™ Seal Technology
- Single Handle Deck Mount
- 3 Hole Sink Applications
- 4 Centerset
- 5" Long Spout



Part #	Description	Price
24806105	520-MPU-DST Classic S/L Lav Faucet W/PU	168.00

522-MPU-DST Classic Lav Faucet-Knob

- Classic Series
- DST-DIAMOND™ Seal Technology
- Single Handle Deck Mount
- 3 Hole Applications
- 4 Centerset
- 5" Long Spout



Part #	Description	Price
24806110	522-MPU-DST Classic S/L Lav Faucet W/ PU	174.00

DELTA-Delta Faucets
Page P-10 - RW List Prices

578-MPU-DST Leland Lav Faucet-Lever

- 5-8" long, 8-3/8" high spout
- 1 or 3 hole mount (6-1/4" escutcheon plate included).
- Lever handle. Control mechanism is the diamond embedded ceramic disc cartridge.
- Control handle returns to neutral position when valve is turned off.
- DST-DIAMOND™ Seal Technology
- 3/8" O.D. straight, staggered pex supply tubes 35" and 36" long.
- Maximum 1.5 gpm flowrate @ 60 PSI.
- Models include polypropylene pop-up type fitting with plated metal flange and stopper cap.



Part #	Description	Price
24803175	578-MPU-DST Leland CP Lav Fct W/PU	256.00

540-DST - Innovations® Lav Faucet-Lever

- 5-1/4" long, 3-7/8" high spout
- Lever Handle
- DST-DIAMOND™ Seal Technology
- 4" Centerset
- 2.0 gpm @ 80 psi (7.6 L/min @ 551 kPa)
- 3 Hole Installation



Part #	Description	Price
24807291	540-MPU-DST S/L Innovations Lav Fct W/PU	250.00

544-DST - Innovations® With Lav Fct w/Fittings

- 5-1/4" long, 3-7/8" high spout
- 4" Centerset
- DST-DIAMOND™ Seal Technology
- 2.0 gpm @ 80 psi (7.6 L/min @ 551 kPa)
- Red/Blue Handle Indicators

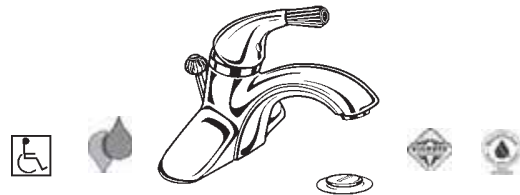

Part #	Description	Price
24803110	544-MPU-DST Innovation S/L Lav Fct	262.00

542-MPU-DST - Innovations® Lav Fct-Knob

- 5-1/4" Long, 3-7/8" High Spout
- 3 Hole Installation - 4" Centerset
- DST-DIAMOND™ Seal Technology
- Clear Knob Handle
- 2.0 gpm @ 80 psi (7.6 L/min @ 551 kPa)

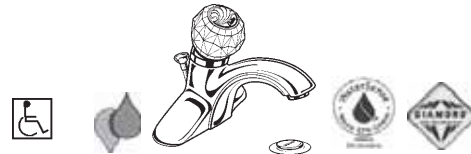

Part #	Description	Price
24803105	542-MPU-DST Innovation Acryl S/L Lav Fct	250.00



DELTA-Delta Faucets
RW List Prices - Page P-11

2502 - Classic Clear Knob Handles

- 2 Hole Installation - 4" Centerset
- Clear Knob Handles W/Red/Blue Indicators
- 2.0 gpm @ 80 psi (7.6 L/min @ 551 kPa)
- With capped lift rod hole and notched undercover plate to accept RP7584 chain and stopper

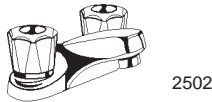

Part #	Description	Price
24810624	2502 Classic Acrylic 2H Lav Faucet L/PU	92.00

2520 - Classic Blade Handles

- 3 Hole Installation - 4" Centerset
- 2.0 gpm @ 80 psi (7.6 L/min @ 551 kPa)
- Blade Handles

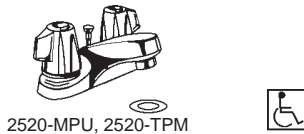

Part #	Description	Price
24810617	2520 Classic Blade 2H Lav Fct W/PLS PU	126.00
24810616	2520-MPU Classic Blade 2H Lav Fct W/PU	134.00

2522 - Classic Clear Knob Handles

- 3 Hole Installation - 4" Centerset
- Clear Knob Handles W/Red/Blue Indicators
- 3-7/16" long spout
- 2.0 gpm @ 80 psi (7.6 L/min @ 551 kPa)



Part #	Description	Price
24810633	2522 Classic Acrylic 2H Lav Fct W/PLS PU	126.00
24810632	2522-MPU Classic Acrylic 2H Lav Fct W/PU	130.00

2521 - Classic 2H Lav Faucet

- 3 Hole Installation - 4" Centerset
- 2.0 gpm @ 80 psi (7.6 L/min @ 551 kPa)

Uses: H21
H25

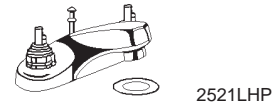

LHP Faucets Require Handles and Accents for a Complete Faucet

Part #	Description	Price
24810640	2521-LHP Classic CP 2H Lav Fct L/Handle	128.00

2530 - Innovations® 2H Lav Faucet

- 3 Hole Installation - 4" Centerset
- 5-1/4" Long, 3-7/8" high rigid spout
- 2.0 gpm @ 80 psi (7.6 L/min @ 551 kPa)

Uses: H24 A24
H25
H26
H27

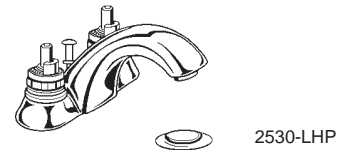

LHP Faucets Require Handles and Accents for a Complete Faucet

Part #	Description	Price
24800055	2530-LHP Innovations CP 2H Lav Fct	180.00

3544 - Classic Widespread Clr Knob Lav Fct

- 3 Hole Installation
- 6" To 16" Center Widespread
- 4-3/4" Long Spout
- Clear Knob Handles w/Red/Blue Indicators
- 2.0 gpm @ 80 psi (7.6 L/min @ 551 kPa)

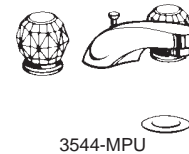

Part #	Description	Price
24810733	3544-WFMPU Classic 8CC Lav Faucet W/PU	260.00

DELTA-Delta Faucets
Page P-12 - RW List Prices

2575-MPU Leland 2H Lav Faucet

- 4" centerset.
- 4-1/4" long, 6 3/8" high rigid spout.
- 1/4 turn handle stops.
- Control mechanism is a rotating cylinder type with stainless steel plate and 90° rotation, with replaceable non-metallic seats operating in stainless steel lined sockets.
- Hot and cold stems are interchangeable.
- 1/2"-14 NPSM threaded male inlet shanks.
- 1.5 gpm @ 60 psi, 5.7 L/min @ 414 kPa



Part #	Description	Price
24803180	2575-MPU Leland CP Lav Fct W/PU	180.00

3530 - Innovations® 2H Lav Faucet

- 3 Hole Installation
- 6" To 16" Center Widespread
- 5-1/4" Long, 3-7/8" high rigid spout
- Scalloped handle bases
- 2.0 gpm @ 80 psi (7.6 L/min @ 551 kPa)

Uses: H24 A24
H25
H26
H27

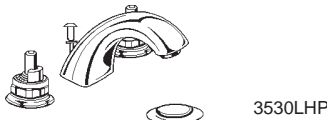

LHP Faucets Require Handles and Accents for a Complete Faucet

Part #	Description	Price
24800100	3530-LHP Innovations 8CC Lav Faucet	308.00

See what Delta can do.

3575-MPU Leland 2H Widespread Lav Faucet

- Solid brass fabricated end valve and spout bodies.
- Widespread - 6" to 16" centers.
- 4-1/4" long, 5-5/8" high rigid spout.
- Quick-Snap® installation.
- 1/4 turn handle stops.
- Hot and cold stems are interchangeable.
- Control mechanism is a rotating cylinder with stainless steel plate and 90° rotation, with replaceable non-metallic seats operating in stainless steel lined sockets.
- 3/8" O.D. copper supply tubes with 1/2"-14 NPSM adapters.
- Includes metal drain with pop-up type drain fitting with plated flange and stopper cap.
- 1.5 gpm @ 60 psi, 5.7 L/min @ 414 kPa
- Note: Standard mounting deck thickness can be extended 1" with RP10612



Part #	Description	Price
24803185	3575-MPU Leland CP Lav Fct W/PU	316.00

4530 - Innovations® 2H Lav Faucet

- 3 Hole Installation - 4" Mini-Widespread
- 5" Long, 4-1/2" high rigid spout
- Scalloped handle bases (Widespread only)
- 2.0 gpm @ 80 psi (7.6 L/min @ 551 kPa)

Uses: H24 A24
H25
H26
H27

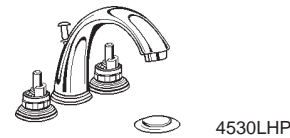

LHP Faucets Require Handles and Accents for a Complete Faucet

Part #	Description	Price
24800053	4530-LHP Innovations 2H 4CC Mini Lav Fct	252.00



DELTA-Delta Faucets
RW List Prices - Page P-13

DELTA TUB AND SHOWER FAUCETS

T13020 Classic Monitor® Series 13 Lever

- Uses Multichoice Universal Valve
- Metal Lever Handle
- Handle Adjusts Temperature
- Monitor® Scald-Guard®
- No Volume Control

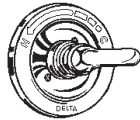

MultiChoice™ Universal Valve plus Trim Kit are required for a complete faucet.



Part #	Description	Price
24808025	T13020 Classic Monitor 13 Lvr Valve Trim	84.00

Monitor® Scald-Guard® valve keeps water temperature within +/-3°F

T13022 Classic Monitor® Series 13 Knob

- Uses Multichoice Universal Valve
- Clear Knob Handle
- Handle Adjusts Temperature
- Monitor® Scald-Guard®
- No Volume Control



MultiChoice™ Universal Valve plus Trim Kit are required for a complete faucet.



Part #	Description	Price
24808085	T13022 Classic Monitor 13 Acryl Valve Trim	84.00

T13120 Classic Monitor® Series 13 Tub Lever

- Fits Multichoice Universal Valve
- Metal Lever Handle
- Handle Adjusts Temperature
- Monitor® Scald-Guard®
- 5-1/4" Non-Diverter Spout
- Thread onto 1/2" IPS

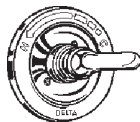

MultiChoice™ Universal Valve plus Trim Kit are required for a complete faucet.



Part #	Description	Price
24808015	T13120 Classic Monitor 13 Lvr Tub Trim	102.00

BT-13210 Core-B Monitor® 13 Shwr

- Back-to-back installation capability.
- Field adjustable means to limit handle rotation into hot water zone.
- 120° - maximum handle rotation.
- All parts replaceable from the front of the valve.
- Temperature only controlled with handle.
- Maintains a balanced pressure of hot and cold water even when a valve is turned on or off elsewhere in the system.
- Monitor® Scald-Guard®



MultiChoice™ Universal Valve plus Trim Kit are required for a complete faucet.

Part #	Description	Price
24803160	BT13210 Core Monitor 14 CP Shower Trim	78.00

T13220 Classic Monitor® 13 Shower Lever

- Uses Multichoice Universal Valve
- Metal Lever Handle
- Handle Adjusts Temperature
- Maintains a balanced pressure of hot and cold water even when a valve is turned on or off elsewhere in the system.
- Monitor® Scald-Guard®
- Touch-Clean Showerhead

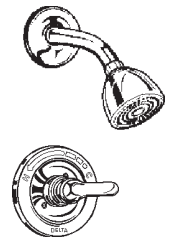

MultiChoice™ Universal Valve plus Trim Kit are required for a complete faucet.



Part #	Description	Price
24808020	T13220 Classic Monitor 13 Lvr Shwr Trim	98.00



DELTA-Delta Faucets
Page P-14 - RW List Prices

T13222 Classic Monitor® Series 13 Shwr Knob

- Uses Multichoice Universal Valve
- Clear Knob Handle
- Handle Adjusts Temperature
- Monitor® Scald-Guard®
- Touch-Clean Showerhead

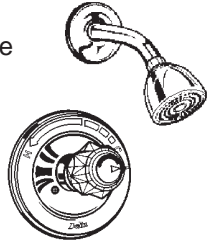

MultiChoice™ Universal Valve plus Trim Kit are required for a complete faucet.



Part #	Description	Price
24808090	T13222 Classic Monitor 13 Acryl Shwr Trim	100.00



DELTA-Delta Faucets
RW List Prices - Page P-15

T13420 Classic Monitor® 13 T&S Lever

- Uses Multichoice Universal Valve
- Metal Lever Handle
- Handle Adjusts Temperature
- Monitor® Scald-Guard®
- Touch-Clean Showerhead
- 5-1/2" Long Pull-Up Diverter Spout



MultiChoice™ Universal Valve plus Trim Kit are required for a complete faucet. 

Part #	Description	Price
24808035	T13420 Classic Monitor 13 Lvr T&S Trim	122.00

T13420-PD Classic Monitor® 13 T&S Lever

- Uses Multichoice Universal Valve
- Metal Lever Handle
- Handle Adjusts Temperature
- Monitor® Scald-Guard®
- Touch-Clean Showerhead
- 6" Long Pull-Down Diverter Spout

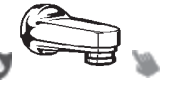
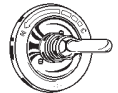

MultiChoice™ Universal Valve and Trim Kit are required for a complete faucet. 

Part #	Description	Price
24808100	T13420-PD Classic Monitor 13 Lvr T&S Trim	122.00

T13422 Classic Monitor® 13 T&S Knob

- Uses Multichoice Universal Valve
- Clear Knob Handle
- Handle Adjusts Temperature
- Monitor® Scald-Guard®
- Touch-Clean Showerhead
- 5-1/2" Long Pull-Up Diverter Spout



MultiChoice™ Universal Valve plus Trim Kit are required for a complete faucet. 

Part #	Description	Price
24808105	T13422 Classic Monitor 13 Acryl T&S Trim	126.00

T13422-PD Classic Monitor® 13 T&S Knob

- Uses Multichoice Universal Valve
- Clear Knob Handle
- Handle Adjusts Temperature
- Monitor® Scald-Guard®
- Touch-Clean Showerhead
- 6" Long Pull-Down Diverter Spout



MultiChoice™ Universal Valve and Trim Kit are required for a complete faucet. 

Part #	Description	Price
24808095	T13422-PD Classic Monitor 13 Acryl T&S Trim	126.00

DELTA-Delta Faucets
Page P-16 - RW List Prices

T14230-LHP Innovations Monitor® 14 Shwr Lever

- Uses Multichoice Universal Valve
- Less Handle (Shown with Kbov)
- Handle Adjusts Temperature
- Monitor® Scald-Guard®
- Touch-Clean Showerhead
- Dual-Spray Function

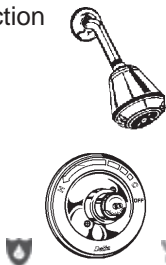

Uses: H74 A74

MultiChoice™ Universal Valve plus Trim Kit are required for a complete faucet. LHP Faucets also require a Handle and Accent Kit for a complete faucet.

Part #	Description	Price
24808055	T14230-LHP Innovations Monitor 14 Lvr Shw Trm	150.00

T14278-H2OLHP Leland Monitor® 14 Shwr

- Maintains a balanced pressure of hot and cold water even when a valve is turned on or off elsewhere in the system.
- Back-to-back installation capability.
- Temperature only controlled with handle.
- H2Okinetic® Technology
- Monitor® Scald-Guard®
- Field adjustable to limit handle rotation into hot water zone.
- 120° maximum handle rotation.
- All parts replaceable from the front of the valve.

Uses: H778

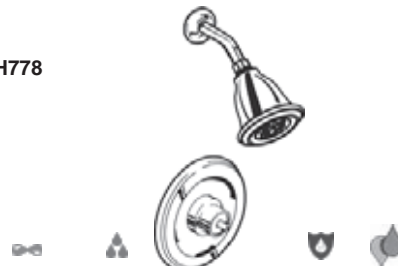

MultiChoice™ Universal Valve R10000 plus Trim Kit are required for a complete faucet. LHP Faucets also require a Handle and Accent Kit for a complete faucet.

Part #	Description	Price
24803190	T14278-H20LHP Leland Monitor14 CP Shwr Trim	112.00

Delta's proprietary H2Okinetic Technology® delivers 36% less water than standard showerheads. H2Okinetic Technology uses larger water droplets, which not only retain heat better, but also create a warmer, more luxurious spray that blankets the body.



**DELTA-Delta Faucets
RW List Prices - Page P-17**

BT13410 Core-B Monitor® 14 T&S

- Back-to-back installation capability.
- Field adjustable means to limit handle rotation into hot water zone.
- 120 - maximum handle rotation.
- All parts replaceable from the front of the valve.
- Temperature only controlled with handle.
- Monitor® Scald-Guard®
- Maintains a balanced pressure of hot and cold water even when a valve is turned on or off elsewhere in the system.
- 1/2" -14 threaded tub spout



MultiChoice™ Universal Valve plus Trim Kit are required for a complete faucet.



Part #	Description	Price
24803165	BT13410 Core Monitor14 CP T&S Trim	110.00

T14430-LHP Monitor® Series 14 T&S Lever

- Uses Multichoice Universal Valve
- Less Handle
- Handle Adjusts Temperature
- Monitor® Scald-Guard®
- Touch-Clean Showerhead
- Dual-Spray Function
- 6" Pull-Down Diverter Spout



Uses: H74 A74

MultiChoice™ Universal Valve plus Trim Kit are required for a complete faucet. LHP Faucets also require a Handle and Accent Kit for a complete faucet.

Part #	Description	Price
24808070	T14430-LHP Innovations Monitor14 Lvr T&S Trim	186.00

DELTA-Delta Faucets
Page P-18 - RW List Prices

T14478-H2OLHP Leland Monitor® 14 T&S

- Maintains a balanced pressure of hot and cold water even when a valve is turned on or off elsewhere in the system.
- Back-to-back installation capability.
- Temperature only controlled with handle.
- H2Okinetic® Technology
- Monitor® Scald-Guard®
- Field adjustable to limit handle rotation into hot water zone.
- 120° maximum handle rotation.
- All parts replaceable from the front of the valve.
- Showerhead: 1.5 gpm @ 60 psi, 5.7 L/min @ 414 kPa



Uses: H778



MultiChoice™ Universal Valve R10000 plus Trim Kit are required for a complete faucet. LHP Faucets also require a Handle for a complete faucet.

Part #	Description	Price
24803195	T14478-H2OLHP Leland Monitor14 CP T&S Trim	136.00

Monitor® Series 17

T17230 Monitor® 17 Shower Lever

- Uses Multichoice Universal Valve
- Metal Lever Accent
- Handle Adjusts Volumn
- Monitor® Scald-Guard®
- Dial Adjusts Temperature
- Red/Blue Temperature Indicator
- Touch-Clean Showerhead
- Dual Spray Function

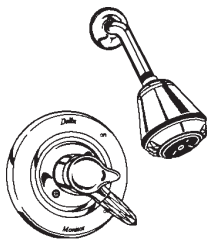

MultiChoice™ Universal Valve and Trim Kit are required for a complete faucet.



Part #	Description	Price
24808030	T17230 Innovations Monitor 17 Lvr Shwr Trim	224.00

T17430 Monitor® Series 17 T&S Lever

- Uses Multichoice Universal Valve
- Metal Lever Accent
- Handle Adjusts Volumn
- Dial Adjusts Temperature
- Monitor® Scald-Guard®
- Red/Blue Temperature Indicator
- Touch-Clean Showerhead
- Dual Spray Function
- 6" Long Pull-down Diverter Spout

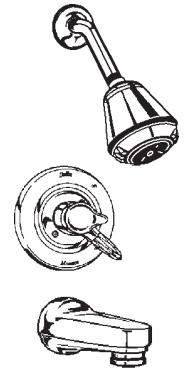

MultiChoice™ Universal Valve and Trim Kit are required for a complete faucet.



Part #	Description	Price
24808040	T17430 Innovations Monitor 17 Lvr T&S Trim	246.00

 This option provides separate controls for the temperature and volume, allowing you to set the temperature and keep it consistent shower after shower.

MultiChoice™ Universal Valve

- Accepts Single Function (Series 13&14), Dual Function (Series 17)
- 1/2 Universal Inlets to Accept 1/2 Copper, 1/2 Iron Pipe
- 1/2 Universal Outlets, Inlets/Outlets Have Male Threads and SWT Copper Connections
- WS=With Screw Driver Stops Single Box Model
PX=Pex Connection Models

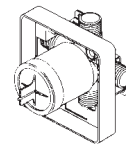

Part #	Description	Price
24808000	R10000-UNBX Roughin SWT/IPS Prs Bal Vlv	54.00
24808010	R10000-PX Roughin Pex Prs Bal Vlv Only	56.00
24808005	R10000-UNWS SWT/IPS Prs Bal Vlv & Stops	78.00



**DELTA-Delta Faucets
RW List Prices - Page P-19**

BT2710 Core-B Roman Tub Faucet

- 6-7/8" long, 4-1/2" high spout
- 3-3/16" from deck to aerator
- Rigid slip on spout
- Order rough separately
- 3-hole 8-16" installation
- 18 gpm @ 60 psi, 68 L/min @ 414 kPa

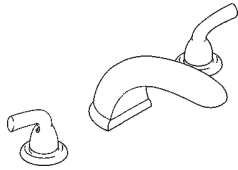

Requires R2707 Rough In Kit and Trim Kit for a complete faucet.

Part #	Description	Price
24803155	BT2710 Core CP Roman Bath Fct	168.00

T2730-LHP Innovations® Roman Tub Faucet

- 3 Hole installation
- 2 5/8" diameter decorative bases
- 7 long rigid slip-on spout
- 4-5/8 from deck to spout outlet
- 18gpm @ 60 psi (68 L/min @ 414kPa)



Uses H61
H64 A64
H65
H66
H67

Requires R2707 Rough In Kit and Trim Kit for a complete faucet. LHP Faucets also require a Handle and Accent Kit for a Complete Faucet

Part #	Description	Price
24811060	T2730-LHP Innovatrons RT Fct Trim L/Handle	206.00

Classic Roman Tub Faucet

- 3 Hole installation
- 3" diameter handle bases
- 8-1/2 long rigid slip-on spout
- 2-7/8 from deck to spout outlet
- 18gpm @ 60 psi (68 L/min @ 414kPa)



Requires R2707 Rough In Kit and Trim Kit for a complete faucet.

Part #	Description	Price
24811085	T2710 Classic RT Fct Trim W/Acrylic Hdls	250.00

R2707 - Roman Tub Rough-In Kit

- 3-Hole Roman Tub Rough-in installation kit
- Flexible deck or ledge mounting arrangement
- Self-locating basis
- Tighten/adjust from above the deck

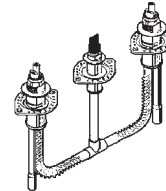

Part #	Description	Price
24811095	R2707 RT Rough In Kit	140.00

DELTA-Delta Faucets
Page P-20 - RW List Prices

RPW324HDF - Personal Shower

- 24" Vertical Bar, 60" Hose
- With vacuum breaker and Wall Supply Elbow
- 2.5 gpm @ 80 psi (9.5 L/min @ 551 kPa)



Part #	Description	Price
24811111	RPW324HDF Personal Shower W/Bar	258.00

Classic - Hand Held Shower

- Complete trim and rough-in
- Flexible deck/ledge mount
- 69" Long Hose
- 2.5 gpm @ 80 psi (9.5 L/min @ 551 kPa)

Uses H54 A54
H55
H56
H57

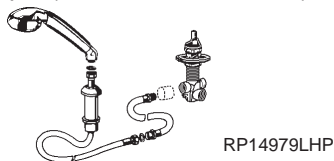

LHP Faucets require Handle Kit for a complete faucet.

Part #	Description	Price
24800018	RP14979 CP RT HH Shower L/Handle	472.00



**DELTA-Delta Faucets
RW List Prices - Page P-21**

DELTA COMMERCIAL FAUCETS

511WFHDF

- Vandal resistant lever Handle
- Red/blue handle indicators
- Stem units with brass stem
- Vandal resistant aerator or spray outlet
- Less Pop-Up, No Lift Rod Hole

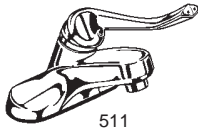

511



Part #	Description	Price
24830037	511LF-HDF S/L Handicap Lav Fct L/PU	170.00

**501-WFHGMHDF
523WFHDF**

- Vandal resistant lever handle
- Red/blue handle indicators
- Stem units with brass stem
- Vandal resistant aerator or spray outlet
- No Lift Rod Hole, With Grid Strainer

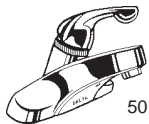

501WFHGMHDF



523



Part #	Description	Price
24807206	501LF-HGMHDF S/L Lav Faucet L/PU	160.00

3579-WFLGHDF

- 5-3/4" Long, 11" high gooseneck spout
- Vandal resistant handle(s)
- Red/blue handle indicators
- Non-vandal resistant spray outlet
- Stainless steel ball (Elbow handle only)
- Stem units with brass stem - stainless steel plate (Blade handles only)
- 2.0 gpm @ 80 psi (7.6 L/min @ 551 kPa) laminar flow



357-WFLGHDF



Part #	Description	Price
24810774	3579-WFLGHDF 8CC Lav Fct W/GN Spout	310.00

DELTAHDL-Delta Faucet Handles and Accents
Page P-22 - RW List Prices

H21 Handles

Part #	Mfg #	Description	Price
49558670	H21 RP19660	Chrome/Clear Knobs	22.30

H22 Handles and A22 Accents
Fits Classic Series Faucets

Part #	Mfg #	Description	Price
24830690	H22 RP15249	Chrome	54.38
24830697	H22WH	White	74.10
24830695	H22PB RP15249PB	Pol Brass	98.90
49560545	A22 RP15071	Chrome	30.38
49560550	A22WH	White	33.58
49560567	A22PB RP15071PB	Pol Brass	47.58

H24 Handles and A24 Accents
Fits Innovations & Waterfall Lav & Kitchen Faucets

Part #	Mfg #	Description	Price
24830280	H24	Chrome	56.50
24830255	H24WH	White	69.98
24830293	H24NN	Nickel	101.70
24830290	H24PB	Pol Brass	101.70
24830285	A24	Chrome	32.50
24830288	A24WH	White	35.98
24830287	A24NN	Nickel	37.58
24830289	A24PB	Pol Brass	50.90

H25 Handles
Fits Classic, Innovations and Waterfall Lav and Sinks

Part #	Mfg #	Description	Price
49560598	H25 RP14788	Chrome	80.10
49560615	H25CW RP14788CW	Chr/Wh	96.18
49560617	H25CB RP14788CB	Chrome/Pol Brass	96.18
49560600	H25NN	Nickel	136.10
49560599	H25PB RP14788PB	Pol Brass	136.10

H26 Handles
Fits Innovations Lav Faucets

Part #	Mfg #	Description	Price
49560606	H26 RP14790	Chrome	107.30

H27 Handles
Fits Innovation Lav Faucets

Part #	Mfg #	Description	Price
24825764	H27 RP19530	Chrome	107.30
24825769	H27PB RP19530PB	Pol Brass	169.90

H28 Handles

Part #	Mfg #	Description	Price
49558695	H28 RP6062	Chrome	24.90



DELTAHDL-Delta Faucet Handles and Accents
RW List Prices - Page P-23

H41 Handles

H41

Part #	Mfg #	Description	Price
24830755	H41 RP23495 - Chrome		27.70

H46 Handles

H46

Part #	Mfg #	Description	Price
49560604	H46 RP15081 - Chrome		109.78

H51 Handles

H51

Part #	Mfg #	Description	Price
24815250	H51 - Acrylic for HH Shower		23.90
24815255	H51PB - PB/Acrylic for HH Shower		24.50

H52 Handles and A52 Accents
(A72 Accents May Be Used.)

H52 A52

Part #	Mfg #	Description	Price
24815300	H52 - Chrome		39.58

H54 Handles and A54 Accents
(A74 Accents May Be Used.)
Fits RP14979 Hand Shower

H54 A54

Part #	Mfg #	Description	Price
24815315	H54 - Chrome		45.90
24815321	H54PB - Pol Brass		72.38

H55 Handles
Fits RP14979 Hand Shower

H55

Part #	Mfg #	Description	Price
24815330	H55 - Chrome		57.10
24815335	H55CW - Chrome/White		69.10
24815340	H55CB - Chrome/Pol Brass		69.10
24815350	H55PB - Pol Brass		95.50

H56 Handles
Used for RP14979 Hand Shower

H56

Part #	Mfg #	Description	Price
24815365	H56 - Chrome		60.90

H57 Handles
Used for RP14979 Hand Shower

H57

Part #	Mfg #	Description	Price
24815380	H57 - Chrome		60.90
24815382	H57PB - Pol Brass		109.50

DELTAHDL-Delta Faucet Handles and Accents
Page P-24 - RW List Prices

H61 Handles
Fits Classic or Innovation Roman Tubs

Part #	Mfg #	Description	Price
24830741	H61 RP23495	Chrome/Clear Knob	32.10
24830742	H61PB	Polished Brass	33.50

H65 Handle
Fits Classic Roman Tubs

Part #	Mfg #	Description	Price
49599967	H65	Chrome	105.90
49599960	H65CW	Chrome/White	137.70
49599955	H65CB	Chrome/Pol Brass	137.70
49599965	H65PB	Pol Brass	177.90

H62 Handles and A62 Accents
Fits Classic Roman Tubs

Part #	Mfg #	Description	Price
24830735	H62 RP16616	Chrome	73.18
49560632	A62 RP15426BRS	Chrome	33.18
49560630	A62CL RP15426	Clear	33.18
49560635	A62PB RP15426PBBRS	Pol Brass	51.98

H66 Handle
Fits Classic Roman Tubs

Part #	Mfg #	Description	Price
24830765	H66	Chrome	121.30

H64 Handles and A64 Accents
Fits Classic Roman Tubs

Part #	Mfg #	Description	Price
24830743	H64	Chrome	83.90
24830753	H64NN	Nickel	142.50
24830744	H64PB	Pol Brass	142.50
24830746	A64	Chrome	33.50
24830749	A64CL	Clear	33.50
24830750	A64WH	White	40.30
24830751	A64NN	Nickel	56.90
24830748	A64PB	Pol Brass	56.90

H67 Handle
Fits Classic Roman Tubs

Part #	Mfg #	Description	Price
24830780	H67	Chrome	121.30
24830782	H67PB	Pol Brass	203.90



DELTAHDL-Delta Faucet Handles and Accents
RW List Prices - Page P-25

H71 Handle
Fits Monitor Shower Faucets



H71

Part #	Mfg #	Description	Price
49515290	H71PB RP17655PB	- Clear/Pol Brass Cap	26.78

H72 Handle and A72 Accents
Fits Monitor Shower Faucets



H72 A72

Part #	Mfg #	Description	Price
24815385	H72	- Chrome	39.90
24815389	A72	- Chrome	16.90

H74 Handle and A74 Accents
Fits Classic Monitor® and Monitor®14 Tubs and Showers



H74 A74

Part #	Mfg #	Description	Price
24820076	H74	- Chrome	45.90
24820077	H74NN	- Nickel	76.58
24820078	H74PB	- Pol Brass	76.58
24820081	A74	- Chrome	18.70
24820089	A74NN	- Nickel	33.38
24820085	A74PB	- Pol Brass	33.38

H75 Handle

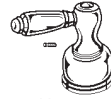

H75

Part #	Mfg #	Description	Price
24820100	H75	- RP19817 - Chrome	57.10
24820125	H75CW	- RP19817CW - Chrome/White	69.10
24820180	H75CB	- RP19817CB - Chrome/Pol Brass	69.10
24820175	H75PB	- RP19817PB Pol Brass	95.50

H77 Handle
Fits Monitor Tub/Showers

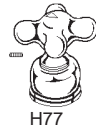

H77

Part #	Mfg #	Description	Price
24820150	H77	- RP19628 - Chrome	60.98
24820225	H77PB	- RP19628PB - Pol Brass	109.70

H778 Handle
Fits Leland Monitor14 Tub/Showers



Part #	Mfg #	Description	Price
24803200	H778	- Chrome	54.58

H79 Handle
Fits Monitor Tub.Shower Faucets



Part #	Mfg #	Description	Price
49557015	H79	- Chrome	32.90

DELTAHDL-Delta Faucet Handles and Accents
Page P-26 - RW List Prices

RP12491 Handles



RP12491

Part #	Mfg #	Description	Price
49522742	RP12491	Chrome	88.90

RP17443 Handle



RP17443

Part #	Mfg #	Description	Price
49505052	RP17443	Chrome	28.38

RP17449 Handle



RP17449

Part #	Mfg #	Description	Price
49505051	RP17449	Clear for Lav	23.50

RP17451 Handle
Fits single handle bath valves



RP17451

Part #	Mfg #	Description	Price
49505049	RP17451	Clear for Tubs	23.50

RP23498 Handle
Fits 2H Kitchen, Lav And Tub And Shower Faucets

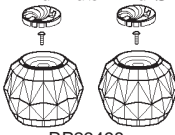

RP23498

Part #	Mfg #	Description	Price
49505050	RP23498	Clear knob handles	22.70

RP2389 Knob Handle
Fits 1H Bathroom Faucets



RP2389

Part #	Mfg #	Description	Price
49559107	RP2389	Delta 1H Clear Knob W/button and screw	22.90

RP2390 Clear Knob Handles
Fits 2H Lav Faucets



RP2390

Part #	Mfg #	Description	Price
49559198	RP2390	Delta 2H Knob Clear Handle	23.50

RP2391 600 Series Clear Handle
Fits Bath Faucets with Chrystal Knobs

- With button & Screws



Part #	Mfg #	Description	Price
49559206	RP2391	Delta 600 Series Clear Handle	23.30



DELTAHDL-Delta Faucet Handles and Accents
RW List Prices - Page P-27

RP2392 Delta Clear Handle
Fits 1H 1300, 1400 & 1600 Series Tub & Shower Faucets



RP2392

Part #	Mfg #	Description	Price
49559255	RP2392	Delta Clear Hnd W/Red/blue Indicators	25.98

RP2393 Ball Lever Handle
Fits 1H Sink Faucet



RP2393

Part #	Mfg #	Description	Price
49559305	RP2393	Delta CP Lever Handle	26.10

RP90 Delta Handle W/Set Screw
Fits Dryden Series T&S Faucets



RP90

Part #	Mfg #	Description	Price
49557747	RP90	Delta Handle W/Set Screw	26.78

RP5645 Lever Elbow Handle
Fits Single Lever Elbow Handle



RP5645

Part #	Mfg #	Description	Price
49559425	RP5645	1H Lever Elbow Handle	38.38

Screws



RP196

Part #	Mfg #	Description	Price
49558125	RP196	Delta CP Screw	8.50

Buttons



RP2411

Part #	Mfg #	Description	Price
49558669	RP19659	Delta 2H Clear Button Set	9.50
24800025	RP17446	Delta Chrome Button	11.30
24800027	RP18373	Delta Chrome Button	10.58
49559404	RP2411	Delta 1H Knob Clear Button	11.50

DELTAPTS-Delta Faucet Parts
Page P-28 - RW List Prices

RP212 Ball
(Not for use with 1300, 1400 or 1600 T/S or pull-out spray models.)



RP212

Part #	Description	Price
49558208	RP212 Delta Ball Assy	20.98
49558211	RP212MBS Pkg Of 6 Ball Assy	51.90

RP70 Ball
(Not for use with pull-out spray models.)



RP70

Part #	Description	Price
49557606	RP70 Delta SS Ball Assy	22.70
49525766	RP70MBS Delta Pkg Of 6 Ball Assy	53.78

RP16423 Reverse Ball
(Not for use with 1300, 1400 T/S)



RP16423

Part #	Description	Price
49530020	RP16423 Delta Reverse Ball	39.98

RP20111 Knob to Lever Conversion
Converts 1H Knob Faucet to 1H Lever Faucet
(Not for use with 1300, 1400 T/S)



RP20111

Part #	Description	Price
49530024	RP20111 Delta Knob To Lever Conversion	58.18

RP61 Cam and Packing Assemblies

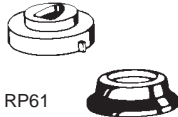

RP61

Part #	Description	Price
49557507	RP61 Delta Sngl Lvr Cam & Pkg Assy	8.50
49557510	RP61MBS Delta Pkg Of 6 Cam & Pkg Assy	24.90

RP188 Cam and Packing Assemblies

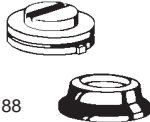

RP188

Part #	Description	Price
49557831	RP188 Delta Sngl Knob Handle Cam & Pkg Assy	11.30
49557850	RP188MBS Delta Pkg Of 6 Cam & Pkg Assy	29.90

Adjustable Ring



RP250

Part #	Description	Price
49558220	RP250 Delta Adj Ring	7.90

Cap Assembly



RP50

Part #	Description	Price
49557408	RP50 Delta CP Cap Assy	26.58

O-Rings



RP25 OO
RP14414

Part #	Description	Price
49557309	RP25 Delta 1H Sink Spout O-Ring Kit	11.30
49557312	RP25MBS 12Pk O-Rings	16.58
49559005	RP2055 Delta Spout O-Ring	11.98
49520137	RP14414 2Pk O-Rings for RP19804 Cartridge	7.30



**DELTAPTS-Delta Faucet Parts
RW List Prices - Page P-29**

RP4993 Seat & Spring



RP4993

Part #	Description	Price
49560121	RP4993 Delta Seat & Spring	9.38

RP3427MBS Springs



Part #	Description	Price
49524783	RP3427MBS Delta Pkg Of 24 Springs	22.30

RP1806 Seats



Part #	Description	Price
49524775	RP1806MBS Delta Pkg Of 24 Seats	30.38

RP28603 Seats, Springs & Quad Seal for 1700

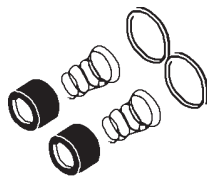

Part #	Description	Price
49520150	RP28603 Seats, Springs & Quad Seal for 1700	10.10

RP3614 Delta Internal Repair Kit

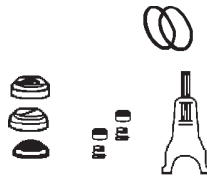

Part #	Description	Price
49557002	RP3614 Delta Internal Repair Kit	17.90

RP5649 Diverter Assemblies



Part #	Description	Price
49558661	RP5649 Delta CP Diverter Assy	37.98
49558663	RP5649PB PB Diverter Assy	56.50

Limit Stops



Part #	Description	Price
49520140	RP19807 Delta Rotational Limit Stop	5.50

RP1740 2H Stem Unit Cylinder Assembly

- With SS Plate
- Not for use with slow close faucets



Part #	Description	Price
49558802	RP1740 Delta 2H Stem Unit Cylinder Assy	18.30
49525770	RP1740MBS Delta Pkg Of 6 Stem Assy	48.70

RP8230 Ceramic Stem Unit

- Ceramic stem assembly
- Not for use with slow close faucets

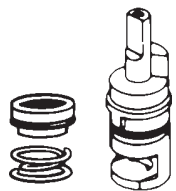

Part #	Description	Price
24860350	RP8230 Delta Ceramic Stem Unit	39.10
24860353	RP8230MBS Pkg Of 6 Ceramic Stem Unit	175.78

RP1991 1600 Series Stem Unit Assy



Part #	Description	Price
49558893	RP1991 Delta 1600 Series Stem Unit Assy	46.98
49558896	RP1991MBS Pkg Of 4 1600 Series Stem Assy	118.90

DELTAPTS-Delta Faucet Parts
Page P-30 - RW List Prices

Cartridge Assemblies



RP19804

Part #	Description	Price
49520135	RP19804 Delta 1300/1400 Cartridge Assy	90.78
49558910	RP32104 Delta Cart Assy For 1500/1700 Valve	120.18
49558915	RP25513 Delta Cartridge For HDF Faucets	32.98
49557010	RP46074 Delta Cartridge For R10000 Valve	86.50

Stem Extender



Part #	Description	Price
49558668	RP18627 Delta Stem Extender	8.30

RP5650 Spout



RP5650

Part #	Description	Price
49559465	RP5650 Delta CP 8 Spout Assy	63.38

Escutcheons



RP5883

Part #	Description	Price
24809100	RP5883 Delta 600/1600 Series Escutcheon	52.90

Shower Cover Up Plates



RP557

Part #	Description	Price
49558505	RP29827 Delta CP Shwr Cover Plate	47.70
49558507	RP29827PB PB Shower Cover Plate	199.30

Seats & Springs Kit

- 12-RP1181-Springs Long Pre-1970
- 12-RP4993 plus 24 Extra Seats-Springs & Seats



RP4039

Part #	Description	Price
49560105	RP4039 Delta Bulk Repair Kit	85.30

Sleeve Extenders for 2600/2800 T&S

- For Clear Knob & Lever 2 Handles
- Extends rough-in depth by 1"

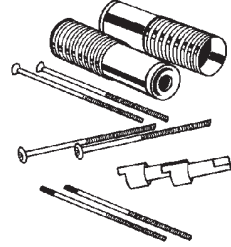

Part #	Description	Price
49558666	RP19156 Delta Sleeve Extenders	139.10

Cambridge 28T9 Faucet Repair Kits

Part #	Description	Price
49558905	060058A Cambridge Integral Stop Kit For 28T9	45.78
49558900	060034A Cambridge Stem Set For 28T9 Faucet	44.98



GERBER-Gerber Faucets
RW List Prices - Page P-31

Maxwell Single Handle Sink Faucet

- Chrome plated housing
- Solid metal lever handle
- Ceramic disc cartridge
- Working parts can be easily replaced
- 8In D-tube spout, 8In centers for mounting
- 1/2" NPSM supply connection w/brass supply nuts
- 2.2 gpm (8.3 L/min) maximum aerator at 60 psi

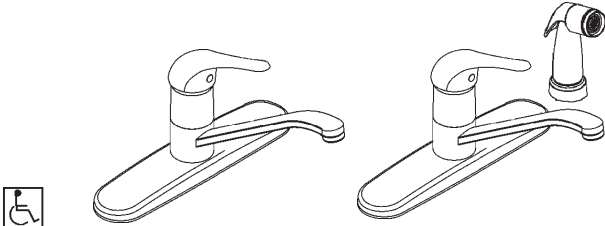

Part #	Description	Price
34705115	40-110 Maxwell CP S/H Sink Fct L/Spray	90.00
34705120	40-112 Maxwell CP S/H Sink Fct W/Spray	104.00

Allerton Single Handle Pull-Out Sink Faucet

- 1 or 3 Hole Installations
- Transitional styling
- Ceramic disc cartridge
- 2.2 gpm (8.3 L/min) Maximum Aerator at 60 psi
- Fully ADA compliant
- Limited Lifetime Warranty

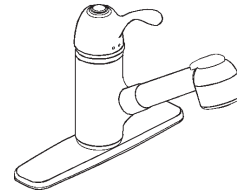

Part #	Description	Price
34705100	40-485 Allerton CP Pullout Spout S/H Sink Fct	298.00

Allerton Single Handle Sink Faucet

- Ceramic disc cartridge
- Chrome finish
- 2.2 gpm (8.3 L/min) maximum aerator at 60 psi
- Limited Lifetime Warranty

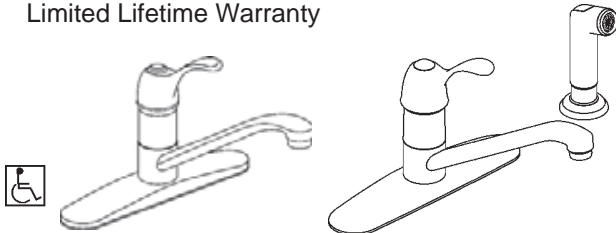

Part #	Description	Price
34705105	40-151 Allerton CP S/H Sink Fct L/Spray	116.00
34705110	40-451 Allerton CP S/H Sink Fct W/Spray	146.00

GERBER-Gerber Faucets
Page P-32 - RW List Prices

Maxwell Two Handle Sink Faucet

- Chrome plated cover plate
- Metal handles with hot and cold index buttons
- Ceramic disc cartridges
- Working parts can be easily replaced
- 8In D-tube spout, 8In centers for mounting
- 2.2 gpm (8.3 L/min) maximum aerator at 60 psi
- 1/2In NPSM supply connection w/brass supply nuts

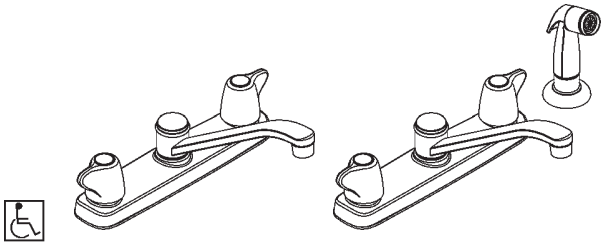

Part #	Description	Price
34705125	42-113 Maxwell CP 2H Sink Fct L/Spray	90.00
34705130	42-115 Maxwell CP 2H Sink Fct W/Spray	106.00

Classic Two Handle Hardwater® Sink Faucet

- Cast brass, heavy chrome plated body, less spray
- Ceramic disc cartridges
- 10In D-tube spout
- Working parts can be easily replaced
- 8In centers for mounting
- 2.2 gpm (8.3 L/min) @ 60 psi maximum aerator
- 1/2In NPSM supply connections with brass coupling nuts



Part #	Description	Price
34706150	52-000 HW 2H Sink Fct L/Spry	132.00
34706160	52-010 HW 2H Sink Fct W/Spry	168.00

Classic Two Handle Sink Faucet

- Chrome Finish
- Compression stems with renewable brass seats
- 8In D-tube spout
- 8In Centers for mounting
- Cast brass underbody
- Metal handles

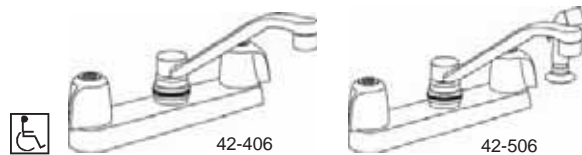

Part #	Description	Price
34705095	42-406 Blade 2H Sink Fct L/Spray	106.00
34705099	42-506 Blade 2H Sink Fct W/Spray	140.00



**GERBER-Gerber Faucets
RW List Prices - Page P-33**

Maxwell Single Handle Lavatory Faucet

- Chrome Finish
- Ceramic disc cartridge
- Metal handle with hot/cold index button
- Stainless steel base w/washerless rubber seals
- Working parts can be easily replaced
- 4In centers for mounting
- 1.5gpm pressure compensating aerator

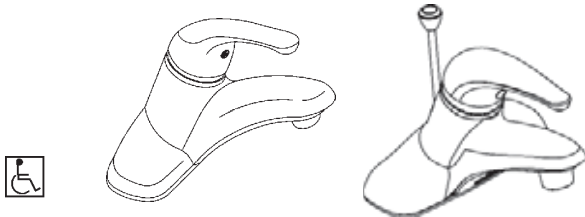

Part #	Description	Price
34705140	40-143 Maxwell CP S/H Lav Fct L/PU	76.00
34705145	40-145 Maxwell CP S/H Lav Fct W/PU	92.00

Allerton Single Handle Lavatory Faucet

- Chrome finishes
- 4In centers, brass pop-up
- Transitional styling
- Ceramic disc cartridge
- Pressure compensating flow rate 1.5 gpm @ 60 psi



Part #	Description	Price
34705135	40-584 Allerton CP S/H Lav Fct W/PU	140.00

 **WaterSense, a new voluntary public-private partnership program sponsored by the U. S. Environmental Protection Agency selects water efficient products that are independently tested and certified.**

Generally, WaterSense labeled products will be about 20 percent more water efficient than their less efficient counterparts in the same category.

Within the United States, the Company operates 4 manufacturing plants and makes its corporate headquarters in Lincolnwood, IL. The plants feature highly automated lines and the latest technology in recycling. Distributing worldwide, the Company's product lines include: ceramic disc cartridge single and two-handle faucets and valves marketed as Gerber Hardwater® products as well as traditional compression stem and washerless faucets and valves.

This complete faucet product offering is for residential and commercial applications.

Gerber's people-oriented attitude carries over in the products it designs for the changing needs of today's homeowner. The Company's focus is to manufacture high quality plumbing products at affordable prices. The high performance and tasteful design of its products reflect the Company's emphasis on current technology and style.

A leader in new product development, the Company has recently introduced several new faucet lines.

To answer consumers' concerns about the damaging, corrosive effects of water, the Company offers a complete line of Gerber Hardwater® kitchen faucets, lavatory faucets and tub/shower valves. These products are specifically designed to fight water's corrosive properties which can cause damage to internal working parts.

The new single and two handle designs are based on Gerber's extensive research and field testing. The result is a more durable, longer lasting faucet and tub/shower valve. At the heart of the new design is the special Ceramaflo™ ceramic disc cartridge which protects against the damaging, corrosive effects of water. Gerber Hardwater® faucets and tub/shower valves are backed with a lifetime warranty against leaks and drips.

To meet the greater performance and convenience requirements of today's consumer, the Gerber Hardwater® single-handle faucets and anti-scald pressure-balance tub/shower valves are supplied with a temperature limit stop. The temperature limit stop maintains water temperature within 1° - 3°F, even when there is a sudden drop of water pressure.

Gerber's engineering staff works closely with the American Society of Plumbing Engineers (ASPE) in developing performance tests for the new standards developed by the American National Standards Institute (ANSI). A majority of Gerber products meet Canadian Standards Association requirements and are "CSA Certified."

Reeves-Wiedeman Company

Emporia, Ks	Grandview, Mo	Independence, Mo	KCMO-Downtown	KCMO-Midtown	KCMO-Waldo	Lawrence, Ks	Junction City, Ks	Leavenworth, Ks
Liberty, Mo	Lees Summit, Mo	Lenexa, Ks	Manhattan, Ks	Maryville, Mo	Olathe, Ks	Riverside, Mo	Saint Joseph, Mo	Topeka, Ks

Shaded Items are Non-Stock

GERBER-Gerber Faucets
Page P-34 - RW List Prices

Maxwell Two Handle Lavatory Faucet

- Chrome Finish
- Ceramic disc cartridges
- Metal handle with hot and cold index buttons
- Washerless valve stems with rubber seals
- Working parts can be easily replace
- 4In centers for mounting
- 1.5 gpm (5.7 L/min) @ 60 psi maximum aerator
- 1/2In NPSM supply connection w/plastic coupling nuts

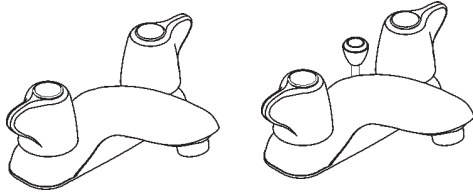

Part #	Description	Price
34705155	43-143 Maxwell CP 2H Lav Fct L/PU	68.00
34705160	43-145 Maxwell CP Lav Fct W/PU	86.00

Classic Two Handle Lav Faucet 4" CC

- One piece heavy chrome plated solid brass casting
- 4" centers for mounting
- Compression
- 2.2 gpm @ 60 psi
- Metal handles

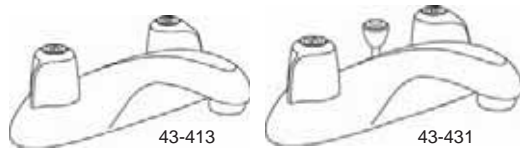

Part #	Description	Price
34704163	43-413 2H Lav Fct L/PU	90.00
34704122	43-431 Blade 2H Lav Fct W/PU	130.00

Allerton Two Handle Lavatory Faucet

- Chrome finish
- 4In centers, brass pop-up
- Transitional styling
- Ceramic disc cartridges
- 1.5 gpm (5.7 L/min) maximum aerator at 60 psi

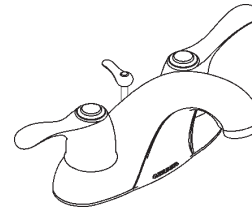

Part #	Description	Price
34705150	43-462 Allerton CP 2H Lav Fct W/PU	130.00

Classic Two Handle Hardwater® Lav Faucet

- Cast brass centerset body
- 2 piece stylized Gerber Hardwater® handles
- Ceramaflo ceramic disc cartridges
- Working parts can be easily replaced
- 4In centers for mounting
- 2.2 gpm (8.3L/min) @ 60 psi maximum aerator
- Metal pop-up
- Gerber Hardwater handles

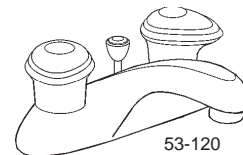

Part #	Description	Price
34704170	53-120 Hw 2H Lav Fct W/PU	142.00



**GERBER-Gerber Faucets
RW List Prices - Page P-35**

Classic Two Handle Widespread Lav Faucet

- Metal Pop-up
- Cast brass end valves and spout body
- Metal handles with acrylic hot and cold index buttons
- Compression stems with renewable brass seats
- Working parts can be easily replaced
- Compression
- 8" - 12" rigid copper and flex connectors
- 2.2 gpm (8.3 L/min) @ 60 psi maximum aerator

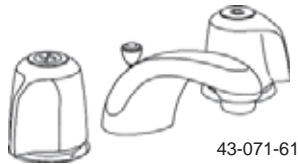

Part #	Description	Price
34704205	43-071-61 8CC Lav Fct W/PU	230.00

Classic Two Handle Laundry Faucet W/Swing Spout

- Cast brass underbody with heavy chrome plated brass shell
- 6" swing spout
- 4" centers for mounting
- Compression
- 2.2 gpm @ 60 psi
- 1/2" NPSM supply connections with brass coupling nuts
- Metal handles



Part #	Description	Price
34706440	49-244 Laundry Faucet	90.00

Classic Two Handle Gooseneck Bar Faucet

- Cast brass underbody with heavy chrome plated brass shell
- With Gooseneck Spout
- 4In Centers for mounting
- Compression
- 2.2 gpm @ 60 psi
- Metal handles



Part #	Description	Price
34706465	49-251 Bar Sink Faucet	98.00

GERBER-Gerber Faucets
Page P-36 - RW List Prices

Classic Two Handle 6" Centerset Tub Filler

- Compression stems
- Body cast of high copper content brass
- Exposed parts have heavy chrome plated finish
- Working parts can be easily replaced
- 1/2In I.P.S. or 1/2In nominal copper sweat connections
- 6In centers with sliding sleeve escutcheons
- ADA compliant metal handles operate with less than 5 lbs. force
- Zinc die cast tub spout

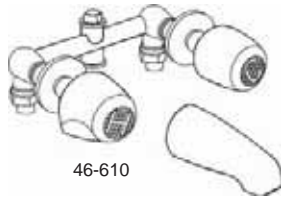

46-610



Part #	Description	Price
34700310	46-610-83 2H IPS/SWT Tub Only Valve	122.00

Classic Two Handle 8" Centerset Tub Filler

- Tub Filler Only
- Sliding Sleeve Escutcheon
- 8In centers
- Compression
- 2.5 gpm @ 80 psi
- IPS/Sweat
- Metal handles

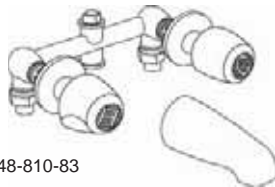

48-810-83



Part #	Description	Price
34701706	48-810-83 2H IPS/SWT Tub Valve	124.00

Classic Two Handle Shower Cabinet Valve

- Shower Cabinet Fitting
- Standard head, Short arm
- 3-3/8In centers
- Compression
- 2.5 gpm @ 80 psi
- Metal handles



47-920



Part #	Description	Price
34703348	47-920 3-3/8 Centers Shower Valve	98.00

Classic Two Handle Shower Valve

- Shower fitting only
- Sliding Sleeve Escutcheon
- 8In centers
- Compression
- 2.5 gpm @ 80 psi
- IPS/Sweat
- Metal handles



48-220.83



Part #	Description	Price
34702407	48-220-83 2H IPS/SWT Shower Valve	132.00

Classic Two Handle Corner Pattern Shower Valve

- Left & Right Hand Built-in Shower
- Valves, Union Connections
- Compression Stern



(Sold/Priced per pair)

Part #	Description	Price
34703298	47-150 Shower Valve	104.00

<i>Reeves-Wiedeman Company</i>											
Emporia, Ks	Grandview, Mo	Independence, Mo	KCMO-Downtown	KCMO-Midtown	KCMO-Waldo	Lawrence, Ks	Junction City, Ks	Leavenworth, Ks			
Liberty, Mo	Lees Summit, Mo	Lenexa, Ks	Manhattan, Ks	Maryville, Mo	Olathe, Ks	Riverside, Mo	Saint Joseph, Mo	Topeka, Ks			

Shaded Items are Non-Stock



**GERBER-Gerber Faucets
RW List Prices - Page P-37**

Classic Two Handle 8" Center Tub & Shower Valve

- Lift Spout, Shower Head, Arm, and Flange
- Sliding Sleeve Escutcheon, Ejector Tee
- 8In centers
- Compression Stems
- 2.5 gpm @ 80 psi
- IPS/Sweat
- Metal handles

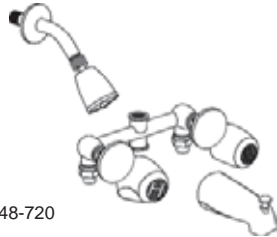

48-720



Part #	Description	Price
34700260	48-720-83 2H IPS/SWT T&S Valve	174.00

Classic Three Handle 8" Center Tub & Shower Valve

- Sliding sleeve Escutcheon
- Compression stems
- Body cast of high copper content brass
- Exposed parts have heavy chrome plated finish
- 1/2In I.P.S. sweat connections
- 8" centers with sliding sleeve escutcheons
- Three valve with center diverter
- Zinc die cast tub spout

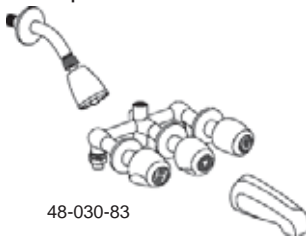

48-030-83



Part #	Description	Price
34700088	48-030-83 3H IPS/SWT T&S Valve	180.00

Maxwell Shower only Trim kit

- Chrome Finish
- Brass waterways
- Washerless cartridge
- Combination sweat/IPS connections
- Back to back capability
- Shower at 2.5 gpm @ 80 psi
- Tub spout in thread/slip in combination
- Fully ADA compliant and Limited Lifetime Warranty



Gerber Plus™ Valve and Trim Kit are required for a complete faucet.

Part #	Description	Price
34705175	G9-012 Maxwell CP Shower Trim Only	48.00

Allerton Shower Only Trim Kit

- Chrome Finish
- Ceramic Disk Cartridge
- Solid Brass Handle
- Tub Spout In Thread/Slip In Combination
- Shower at 2.5 gpm @ 80 psi
- Limited Lifetime Warranty



Gerber Plus™ Valve and Trim Kit are required for a complete faucet.

Part #	Description	Price
34705165	G9-320 Allerton CP Shower Trim Only	54.00

GERBER-Gerber Faucets
Page P-38 - RW List Prices

Maxwell Tub/Shower Trim Kit

- Chrome Finish
- Washerless cartridge
- Combination sweat/IPS connections
- Back to back capability
- Brass waterways
- Tub spout in thread/slip in combination
- Shower at 2.5 gpm @ 80 psi
- Limited Lifetime Warranty



Gerber Plus™ Valve and Trim Kit are required for a complete faucet.

Part #	Description	Price
34705180	G9-013 Maxwell CP T&S Trim Only	66.00

PLUS™ Pressure Balance Valves

- Pressure balance valve.
- Compact valve body design.
- Washerless cartridge.
- GS-315-IPS/sweat connections with stops
- GS-314-PEX B&C connections with stops
- Back to back installation feasible.
- Fits all decorative trim kits - Maxwell, Allerton, Brianne, Abigail, Wicker Park, Logan Square, Riverdale, Waveland and Osric.
- Thin wall installation bracket included.

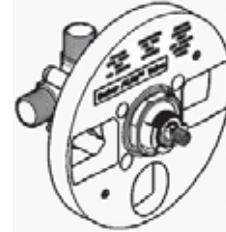

Part #	Description	Price
34705185	GS-315-Pk Gerber SWT/IPS Vlv Only	86.00
34705190	GS-314-Pk Gerber Pex Vlv Only	108.00

Allerton Tub/Shower Trim Kit

- Chrome Finish
- Ceramic Disk Cartridge
- Solid Brass Handle
- Single And Bulk Packaging For New Construction
- Tub Spout In Thread/Slip In Combination
- Shower at 2.5 gpm @ 80 psi
- Limited Lifetime Warranty



Gerber Plus™ Valve and Trim Kit are required for a complete faucet.

Part #	Description	Price
34705170	G9-330 Allerton CP T&S Trim Only	72.00



GERBER-Gerber Faucets
RW List Prices - Page P-39

COMMERCIAL FAUCETS

Two Handle 8" Centerset Sink Fct Less Spray

- Solid cast brass housing with heavy chrome plating, less spray
- Vandal proof wrist blade handles
- Color coded handle screws
- Ceramic disc cartridges
- 8" Centers for mounting
- Vandal Proof 2.2 gpm (8.3 L/min) @ 60 psi maximum aerator
- 1/2" NPSM supply connection
- Max. 1 9/16" deck thickness

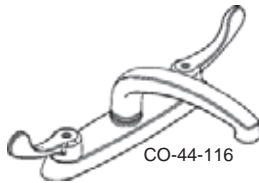

CO-44-116

Part #	Description	Price
34703800	CO-44-119 GN Spt Sink Fct W/WB Hdls	202.00

Two Handle 4" Centerset GN Lav Faucet

- Cast brass underbody with heavy chrome plated brass shell
- Vandal Proof Wrist blade metal handles
- Color-coded handle screws
- Ceramic disc cartridges
- 4" centers for mounting
- Vandal proof 1.5 gpm (5.7 L/min) pressure compensating @ 60 psi maximum aerator
- 1/2" NPSM supply connection
- Max. 1 3/8" deck thickness

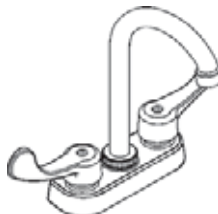

4-251

Part #	Description	Price
34708000	CO-44-254 WB 2H Bar Fct	156.00

Two-Handle 4" Centerset Lav Faucet

- Cast brass, heavy chrome plated body
- Ceramic disc cartridges
- Wrist blade handles with color coded handle screws
- Vandal-proof aerator - 1.5 gpm (5.7 L/min) pressure compensating
- 4" Centers for mounting
- ADA compliant handles operate with less than 5 lbs. force
- Max. 1-5/16" deck thickness



CO-44-411

Part #	Description	Price
34708100	CO-44-411 WB Hdl Lav L/Drain	144.00

Two-Handle 4" Centerset Lav Faucet W/Drain

- Cast brass, heavy chrome plated body
- Ceramic disc cartridges
- Wrist blade handles with color coded handlescrews
- Vandal-proof aerator-1.5gpm(5.7L/min) pressure compensating
- Working parts can be easily replaced
- Brass pop-up drain assembly, 4"centers for mounting
- ADA compliant handles operate with less than 5lbs. force
- Max. 15/16" deck thickness



CO-44-431

Part #	Description	Price
34708200	CO-44-451 WB Lav Fct W/PU	190.00

GERBER-Gerber Faucets
Page P-40 - RW List Prices

Two Handle Widespread Lav Faucet

- Cast brass end valves and spout body
- Wrist Blade metal handles with color coded handle screws
- Ceramic disc cartridges
- Working parts can be easily replaced
- 8" - 12" adjustable flex connectors
- Vandal-proof aerator - 1.5 gpm (5.7 L/min) pressure compensating @ 60 psi max
- ADA compliant handles operate with less than 5 lbs. force
- Max. 1 9/16" deck thickness



Part #	Description	Price
34708250	C0-44-054-61 WB 8 Lav Fct L/Drain	274.00

Two Handle Widespread GN Spout Lav Faucet

- Ceramic disc cartridges
- Gooseneck spout
- Cast brass end valves and spout body
- Vandal proof wrist blade handles with color code handle screws
- 6-12" centers for mounting (with flexible connectors)
- Vandal proof 1.5 gpm (5.7 L/min) pressure compensating @ 60 psi maximum aerator
- 1/2" NPSM supply connection
- Max. 1 9/16" deck thickness



Part #	Description	Price
34748291	C0-44-005-61 WB GN 8 Lav Fct L/Drain	274.00



GERBPTS-Gerber Parts
Page P-42 - RW List Prices

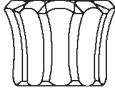

Buttons		
		
Part #	Description	Price
49512585	94-445 Hot Index Button	1.50
49512593	94-446 Cold Index Button	1.50
49512601	94-447 Arrow Index Button	2.18

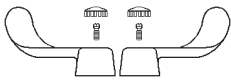

Handle Screws		
		
Part #	Description	Price
49502859	90-700 Handle Screws	2.78

Small Handles		
 		
91-404	94-414	
Part #	Description	Price
49512569	94-404 Small Metal Lever Handle	12.50
49512625	94-414 Small Cryst Handle	11.58

Wrist Blade Handles		
		
Part #	Description	Price
49500280	98-012 Wrist Blade Handle Pair	39.98

Large Handles Short Broach		
 		
94-401	94-434	
Part #	Description	Price
49512551	94-401 Large Metal Short Broach Hdl Assy	14.18
49512610	94-434 Large Cryst Short Broach Hdl Assy	13.18

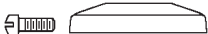
Large Handles Long Broach		
 		
94-402	94-435	
Part #	Description	Price
49512615	94-402 Large Metal Long Broach Hdl Assy	17.10
49512620	94-435 Large Cryst Long Broach Hdl Assy	13.10

Large Handle Sleeves & Escutcheons		
 		
97-600	90-021	
Part #	Description	Price
49518954	97-600 Escutcheon w/Set Screw	13.30
49500218	90-021 Slide Sleeve	11.10

Face Plate		
		
Part #	Description	Price
49518004	97-130 Face Plate Assy	17.70

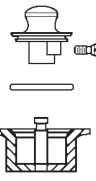
Lift & Turn Stopper		
		
Part #	Description	Price
49500305	98-017 Lift & Turn Stopper/Shoe	37.70

<i>Reeves-Wiedeman Company</i>								
Emporia, Ks	Grandview, Mo	Independence, Mo	KCMO-Downtown	KCMO-Midtown	KCMO-Waldo	Lawrence, Ks	Junction City, Ks	Leavenworth, Ks
Liberty, Mo	Lees Summit, Mo	Lenexa, Ks	Manhattan, Ks	Maryville, Mo	Olathe, Ks	Riverside, Mo	Saint Joseph, Mo	Topeka, Ks

Shaded Items are Non-Stock



MOEN-Moen Faucets
RW List Prices - Page P-43

Chateau Kitchen Faucet

- 7425-No Spray
- 7430-With Spray
- 7434-With Spray in Body

- 1/2" connections
- 8" centers, 3 or 4 hole application

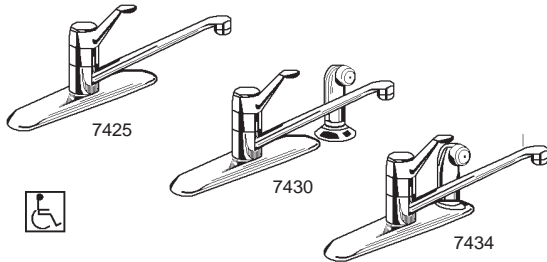

Part #	Description	Price
15075310	7425 S/L Sink Faucet L/Spray	140.00
15045456	67430 Bulk S/L Sink W/Spray	174.00
15075658	7430 S/L Sink Faucet W/Spray	176.00
15080150	7430W White S/L Sink Faucet W/Spray	264.00
15075660	7434 S/L Sink Faucet W/Spray In Base	176.00

Legend Kitchen Faucet

- 7300-No Spray
- 7310-With Spray

- Traditional Metal Lever Handle
- 1/2" connections
- 8" centers, 3 or 4 hole application

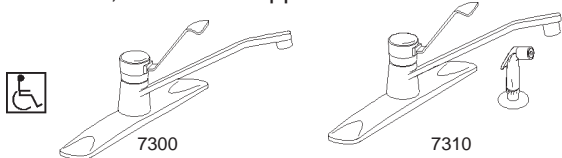

Part #	Description	Price
15073005	7300 S/L Sink Faucet L/Spray	234.00
15073110	7310 S/L Sink Faucet W/Spray	296.00

Monticello Cathedral Spout Kitchen Faucet

- 1/2" connections
- 1 or 3 hole application
- 10" deck plate included - not required
- Integral vacuum breaker
- 2.2 gpm (8.3 L/min)

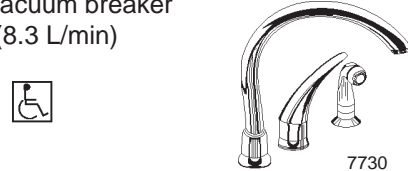

Part #	Description	Price
15077300	7730 Cathedral S/L Sink Faucet W/Spray	362.00

Pullout Spray Kitchen Faucet

67315-Integra

- 1/2" connections
- 1 or 3 hole application
- 10" deck plate included - not required
- Integral vacuum breaker
- 2.2 gpm (8.3 L/min)
- 26" Pullout Spray

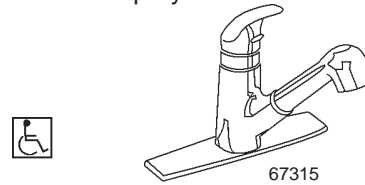

Part #	Description	Price
15044832	67315C Chrome/White PU Spray Sink Faucet	256.00



MOEN-Moen Faucets
Page P-44 - RW List Prices

Chateau 2H Knob Lav Faucet

- Acrylic Handles
- Metal waste
- 1/2" connections
- Centerset 4" centers

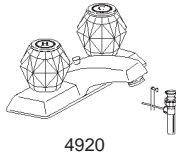

Part #	Description	Price
15025762	4920 Acrylic 2H Lav Faucet W/PU	140.00

Chateau - Lav Faucet - 3/8 Connections

- L4625-Lever Handle**
- 4625-Acrylic Handles**

- Metal waste
- 16" supplies, 4" centers
- 3/8" tubing connections

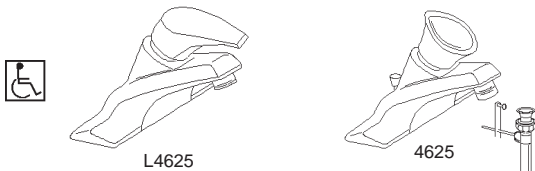

Part #	Description	Price
15046225	L4625 Moen S/L Lavatory Faucet W/PU	176.00
15046255	64625 Bulk Acrylic S/L Lav W/50-50 PU	158.00
15046220	4625 Acrylic S/L Lav Faucet W/PU	176.00

Chateau - Lav Faucet -1/2 IPS Connections

- 4621 - Acrylic Handle W/Metal Waste**
- L4601 - Metal Lever Handle Less Waste**
- L4621 - Metal Lever Handle W/Metal Waste**

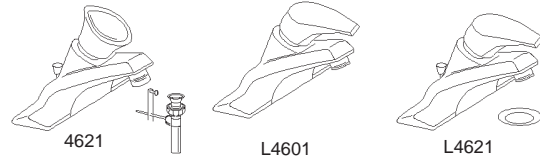

Part #	Description	Price
15046204	4621 S/L Lavatory Faucet W/PU	176.00
15046206	4621P Polished Brass Acrylic Lav Faucet W/PU	298.00
Part #	Description	Price
15046200	L4601 S/L Lav Faucet L/PU	142.00
15046210	L4621 S/L Lavatory Faucet W/PU	176.00

Monticello-Lav Faucet

- 4550-Require Handle Inserts**
- 4551 Includes Handle Inserts**

- Lever Handles
- Metal waste
- 1/2" connections
- Centerset 4" centers



Part #	Description	Price
15001580	4551 Chrome 2H Lav Faucet W/Pop Up	254.00
15001583	4550CP Ch/PB 2H Lav Faucet W/Pop Up	316.00

Moen
Buy it for looks.
Buy it for life.



MOEN-Moen Faucets
RW List Prices - Page P-45

Chateau Knob Handles Tub/Shower

2982-2 Valve
2995-3 Valve

- Acrylic Handles
- Easy Clean showerhead, arm & flange
- Diverter spout
- Union nut & adapter

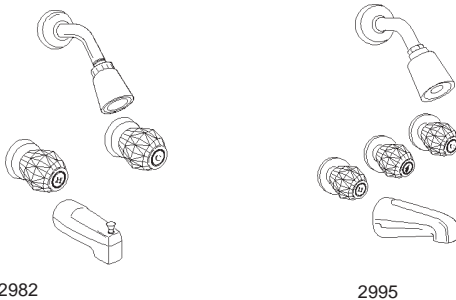

Part #	Description	Price
15025763	2982 IPS 2H T&S Valve	182.00
15024255	2995 Acrylic 3H Ips T&S Valve	214.00

Chateau Acrylic Handle Shower

2625- 3 Port
2739 - 4 Port with diverter spout

- Acrylic handle
- Easy Clean showerhead, arm & flange

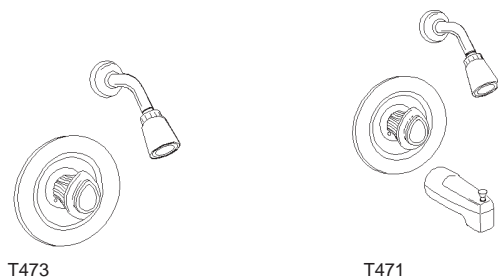

Part #	Description	Price
15031760	T473 Bulk Acrylic S/L Shower Trim	48.00
15031755	T471 Bulk Acrylic S/L SWT T&S Trim	78.00
15027209	62720 Bulk SWT 4 Port T&S Rough In Valve	108.00

Chateau Posi-Temp T&S

2352 - Acrylic Handle Shower Valve
2353 - Acrylic Handle Tub & Shower Valve
L2352-Lever Handle Shower Valve
L2353 - Lever Handle Tub & Shower Valve

- 4 port
- Posi-temp pressure balancing
- Adjustable temperature limit stop
- Easy Clean showerhead, arm & flange
- Diverter spout (2353 & L2353)

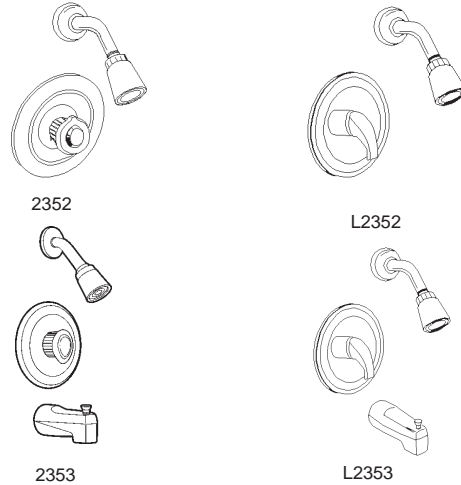

Part #	Description	Price
15014625	2352 Chrome S/L Press Bal SWT Shower Valve	164.00
15014605	2353 Chrome S/L Press Bal SWT T&S Valve	186.00
Part #	Description	Price
15027382	T182 Bulk Acrylic S/L Press Bal Shower Trim	42.00
15027388	TL182 Moen Bulk Lever Hdl Press Bal Shower Trim	42.00
15027383	T183 Bulk Acrylic S/L Press T&S Trim	68.00
15027390	TL183 Moen Bulk Lvr Hd1 Press Bal T&S Trim	68.00
Part #	Description	Price
15027385	62320 Bulk Press Bal SWT Rough In Shwr Vlv	118.00
15014620	L2352 Chrome S/L Press Bal SWT Shwr Vlv	164.00
15014600	L2353 Chrome S/L Press Bal SWT T&S Vlv	186.00



MOEN-Moen Faucets
Page P-46 - RW List Prices

Moentrol Valve only

- Acrylic Handle
- Pressure balancing
- Volume control
- 4 port
- Adjustable temperature limit stop
- Integral check stops

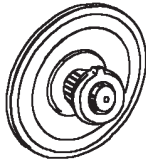

3170

Part #	Description	Price
15031701	3170 Acrylic S/L Press Bal SWT Valve Only	254.00

Moentrol Tub and Shower Valves

- 3175-Acrylic Handle-Shower Valve**
- L3175-Lever Handle-Shower Valve**
- 3189-Acrylic Handle-Tub&Shower Valve**
- L3189-Lever Handle-Tub&Shower Valve**

- Pressure balancing
- Volume control
- 4 port
- Adjustable temperature limit stop
- Integral check stops
- Easy Clean showerhead, arm & flange



3175



L3175



3189

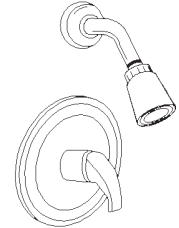

L3189

Part #	Description	Price
15031750	3175 Acrylic S/L Press Bal SWT Shower Valve	282.00
15031758	L3175 Lvr S/L Press Bal SWT Shower Valve	282.00
15004166	3189 Acrylic S/L Press Bal T&S Valve	320.00
15004170	L3189 S/L Press Bal T&S Valve	320.00



MOEN-Moen Faucets
RW List Prices - Page P-47

T951CP-Monticello Roman Tub

- 10" spout
- Order Rough-In + Trim Kit + 2 Large Handles to get Complete Faucet

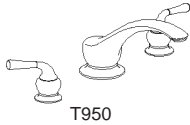

Part #	Description	Price
15049999	4999 Roman Tub SWT Rough In Valve Only	144.00

Monticello Lever Handle Inserts
Large handle (2) carded

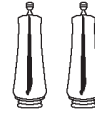

97372 - 3, 6, 7, & 5

Part #	Description	Price
15001850	97372 Chrome Lg Lever Handle Insert	64.00
15001875	97376 Porcelain/Chrome Lg Lever Hnd Insert	88.00

Monticello Lever Handle Inserts
Small handle (2) carded



97557-8, 9 & 60

Part #	Description	Price
15001775	97557 Chrome Sm Lever Handle Insert	64.00
15001825	97559 Porcelain/Chrome Sm Lever Hnd Insert	74.00

Monticello Lever Handle Inserts
Large handle (1) carded



97462- 3, 6, & 7

Part #	Description	Price
15001930	97462 Chrome Lg Lever Handle Insert	48.00
15001935	97466 Porcelain/Chrome Lever Handle Insert	56.00



MOENPRTS-Moen Parts
Page P-48 - RW List Prices

2H Replacement Cartridges



1224

Part #	Description	Price
49536931	1224 2H Faucet Replacement Cartridge	24.30

Positemp Replacement Cartridges



1222

Part #	Description	Price
49536912	1222 Positemp Replacement Cartridge	90.90

Magnum Replacement Cartridges



1225

Part #	Description	Price
15011940	1225 Magnum Replacement Cartridge	39.50

Cartridge Repair



98040



96365

Part #	Description	Price
49536920	98040 Positemp Cartridge Repair Kit	25.98
49536940	96365 Retainer Clips For 1200/1225 Cart	13.78

Brass Replacement Cartridges



1200

Part #	Description	Price
15011901	1200 Brass Replacement Cartridge	52.70

Balancing Spool, Moentrol Tub/Shower

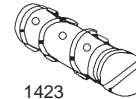

1423

Part #	Description	Price
49538002	1423 Moentrol Pressure Spool	127.18

Cartridge Puller (1200 & 1225 1-H Only)

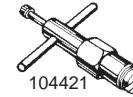

104421

Part #	Description	Price
49554553	104421 Cartridge Puller	75.18



**MOENPRTS-Moen Parts
RW List Prices - Page P-49**

Cartridge Puller for Moen Faucets

Removes Moen® stems and Moen® cartridges from faucets and shower valves. Also removes the Posi-Temp® tub/shower cartridge.

- Removes brass cartridges
- Removes brass stems
- Removes plastic stems & cartridges
- Precision made
- High quality steel components
- One piece construction
- Easy to use



Part #	Description	Price
89184010	7040 Pasco Moen Cartridge Puller	33.50

Stem & Cartridge Wrench for Moen Faucets



Part #	Description	Price
49111380	T161 Stem & Cartridge Wrench For Moen Fct	22.10

Retainer Clip

Legend, Chateau, Boutizue, Moentrol Lav & tub/shower, knob handle



Part #	Description	Price
49535057	883 Retainer Clip	7.78

**Retainer Clip, Kitchen Lever Handle
(Package of 6)**



Part #	Description	Price
49540107	1883 Pkg Of 6 Retainer Clip	23.90

Spout O-Ring Kit

For 7300, 7500, 7600, 7800, 7900 series
(12 per card)

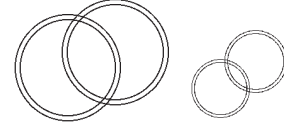

Part #	Description	Price
49530694	117 O-Ring Spout Kit	10.90
49530696	96778 O-Ring Spout Kit	14.58

Diverter Service Kit, Kitchen deck

Model 7310, 7600, and 7800 series



Part #	Description	Price
49554725	91192 Diverter Service Kit	38.50

Stop Tube, T/S, Legend and Chateau

Single Handle, Chrome

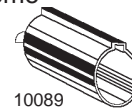

Part #	Description	Price
49552284	10089 CP Bath Stop Tube	16.38



MOENPRTS-Moen Parts
Page P-50 - RW List Prices

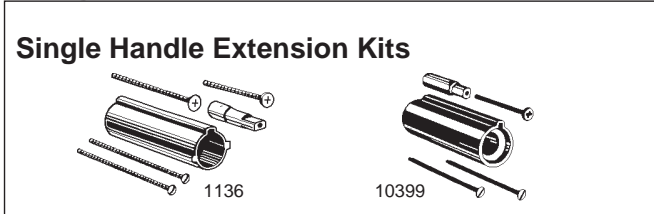

Part #	Description	
49552706	10399 CP Handle Extension	68.98

Timeless designs. Styles unlike anything else. Faucets and fixtures that are livable and enduring. These are just some of the reasons that Moen Incorporated is the number one brand of faucet in North America. But, Moen does more than make faucets. It's also a major supplier of stylish kitchen sinks and innovative bath accessories. Moen is part of Fortune Brands' Home and Hardware group - a leading consumer brands company that includes leading cabinetry, door and lock manufacturers.

A SERIES OF FIRSTS
Besides introducing the world to the single-handle faucet, Moen is known throughout the industry for a series of firsts that include: Washerless cartridge system that replaces seals and washers to ease faucet maintenance Swing'n'Spray® aerator that changes the water flow from a stream to a forceful spray Riser® family of faucets that can lift 10-inches above the sink Pressure-balanced shower valves that reduce the risk of shower shock Lifetime warranties Toll-free consumer help lines for installation or replacement questions

TECHNOLOGY AND INNOVATION
With an emphasis on new technology, Moen has introduced innovative products such as: ChoiceFlo™ the first filtering faucet to feature dual waterways in the spout - with two independent valves - to allow for both filtered and non-filtered water. Revolution® showerhead that spins, twists and twirls the water for a one-of-a-kind showering experience Aberdeen™ pull-down faucet with a patented pause button that stops the flow of water with a touch of a button Immersion™ rainshower technology provides a powerful, rain-drenching shower experience unlike typical rainshowers that have a "drooping" showering pattern similar to the flow from a watering can LifeShine® finish technology that allows designer finishes like brushed nickel to have the durability of chrome M-PACT® common valve system that allows consumers to upgrade their faucets without replacing existing plumbing

STYLISH LUXURY
In 2004, Moen launched ShowHouse® by Moen®, a new line of luxury faucets and accessories for the kitchen and bath, featuring cutting-edge affordable styles for fashion-conscious homeowners. For the kitchen and bath, ShowHouse offers styles that range from sleek and modern to refined and traditional. Products include kitchen, preparatory and bath faucets, luxurious shower, spa and tub faucet options and a complete line of coordinating bath accessories. All are available in beautiful designer finishes. The line also features exclusive powder room collections with uniquely designed faucets and accessories for a coordinated look in the one room your guests are certain to use.

A PROUD PAST
Moen, originally part of Ravenna Metal Products of Seattle, Washington, became part of Stanadyne, Inc., in 1956 as the Company's only consumer brand. Stanadyne was acquired in 1988 by Forstmann-Little & Company. In 1989, Moen was given the status of an independent company and renamed Moen Incorporated before being purchased by MasterBrand Industries, Inc., an operating company of American Brands, in 1990. American Brands became Fortune Brands in 1997, and Moen is now part of the Fortune Brands Home and Hardware group. In the time that Moen has been part of the Fortune Brands family, it has introduced a wide range of consumer-preferred, stylish products - positioning Moen as the number one plumbing brand, both in market share and in the minds of consumers. With Moen, you'll always find the perfect balance between styles you'll love and innovation you can live with. Buy it for looks. Buy it for life®.

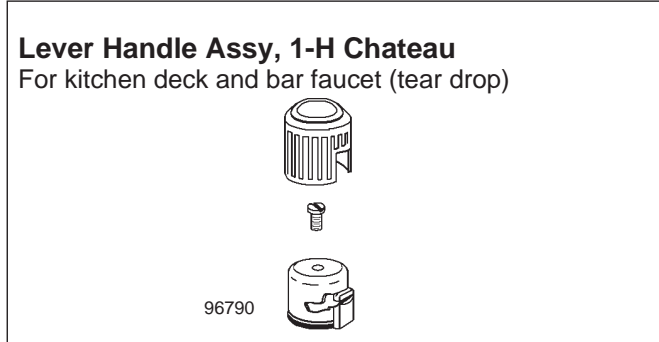

Part #	Description	
49555103	96781 Lever Handle Assembly Kit	36.90



Part #	Description	
49555119	96782 Lav Handle Knob Assembly Kit	39.10

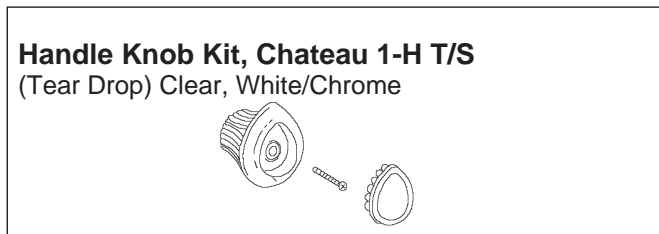

Part #	Description	
49555125	98039 T&S Handle Knob Assembly Kit	39.10



Part #	Description	
49554371	98024 Handle Assembly Kit	35.10
49554389	98025 Bath Handle Assembly Kit	35.10

Emporia, Ks	Grandview, Mo	Independence, Mo	KCMO-Downtown	KCMO-Midtown	KCMO-Waldo	Lawrence, Ks	Junction City, Ks	Leavenworth, Ks
Liberty, Mo	Lees Summit, Mo	Lenexa, Ks	Manhattan, Ks	Maryville, Mo	Olathe, Ks	Riverside, Mo	Saint Joseph, Mo	Topeka, Ks

Shaded Items are Non-Stock



Positemp T&S Knob Handle

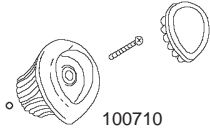

Part #	Description	
49540125	100710 Positemp T&S Knob Handle Kit	29.18

Round Escutcheon, Chateau T/S, 1-H
 Chrome

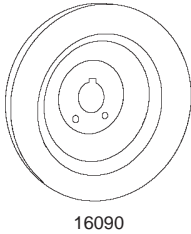

Part #	Description	
49554595	16090 CP Round Escutcheon	46.50

Cover Plates for the Bath

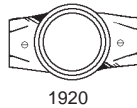

Part #	Description	
49540112	1920 CP T&S Cover Plate	121.90

CENBRASS-CENBRASS - Central Brass Faucets
Page P-52 - RW List Prices

0120-A-Q 8 CC Sink Faucet

- Cast Brass Top Mount on 8in centers with 8in tube spout and 2.2 GPM aerator.
- Replaceable seats
- Quick-Pression Quarter-Turn Stems

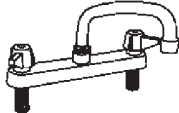

Part #	Description	Price
05013000	0120-A-Q 8 CC Sink Faucet	116.00
05013005	0121-A-Q 8 CC Sink Faucet w/Spray	138.00

0125-A 6 CC Sink Faucet

- Cast Brass Top Mount on 6in centers with 8in tube spout and 2.2 GPM aerator.
- Replaceable seats

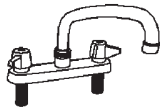

Part #	Description	Price
05013010	0125-A 6 CC Sink Faucet	136.00
05013015	0126-A 6 CC Sink Faucet w/Spray	156.00

0047-UA-Q Service Sink Faucet

- Wall Mount with 1/2-14 NPS female inlets
- 6-inch tube spout with 2.2 GPM aerator
- Replaceable seats
- Polished chrome finish
- Quick-Pression quarter-turn stems

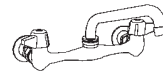

Part #	Description	Price
05013200	0047-UA-Q 8 CC WM Service Sink Faucet	152.00

0048-UA-Q Service Sink Faucet w/Soap Dish

- Wall Mount with 1/2-14 NPS female inlets
- 6-inch tube spout with 2.2 GPM aerator
- Replaceable seats
- Brass soap dish
- Polished chrome finish
- Quick-Pression quarter-turn stems

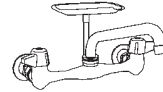

Part #	Description	Price
05013205	0048-UA-Q 8 CC WM Service Sink Faucet w/soap dish	158.00

SU-2806 Adj Inlet Flanges

- Wall Mount Flange
- Female Adjustable 6" to 9-1/2" Centers
- Use on 0047 or 0048 Service Sink Faucet

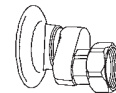

Part #	Description	Price
05013210	SU-2806 6-1/2 to 9-1/2 Adj Inlet Flange	60.10



**CENBRASS-CENBRASS - Central Brass Faucets
RW List Prices - Page P-53**

0072-GSAELS-Q Ledge Sink Faucet

- Concealed Ledge Fitting on 8-inch centers
- 1/2-14 NPS female threads
- Swivel gooseneck spout with 2.2 GPM aerator
- 6-inch brass elbow handles
- Color-coded indexes
- Quick-Pression Quarter-Turn stems
- Replaceable seats
- NOTE: Thickness of sink or countertop cannot exceed 1/8"

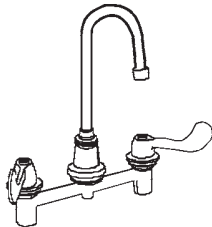

Part #	Description	Price
05013020	0072-GSAELS-Q 8 CC Sink Faucet WB Hdl Rigid GN Spout	198.00

1172-GSAELS-Q Sink Faucet

- Concealed ledge faucet
- Flexible hose connections, adjustable from 6 to 24 inches
- 8" Brass D-spout with 2.2 GPM aerator
- 1/2-14 NPS male threads on inlets
- Quick-Pression quarter-turn stems

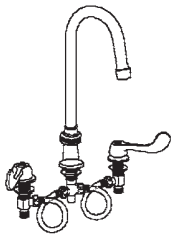

Part #	Description	Price
05013025	1172-GSAELS-Q 6-24 CC Sink WB Hdl Rigid GN Spout	232.00

0287-GSA Double Bar/Pantry Faucet

- 0287-GSA Cast Brass Double Bar/Pantry Faucet
- 1-1/16-14 NPS male shank, copper supply tubes
- Swivel gooseneck spout with 2.2 GPM aerator
- Replaceable seats.



Part #	Description	Price
05013105	0287 GSA1 Hole 2 Hdl Bar Faucet	174.00

0280-GSAC Bar Faucet

- Cast Brass Single Bar Faucet with 1/2-14 NPS male shank x 1-7/8-inches long
- Swivel gooseneck spout with 2.2GPM Aerator
- Replaceable seat
- (Cold only)

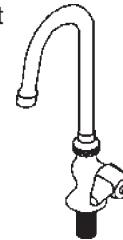

Part #	Description	Price
05013100	0280-GSAC 1 Hole 1 Hdl Bar Faucet	98.00

CENBRASS-CENBRASS - Central Brass Faucets
Page P-54 - RW List Prices

0084-GSAELS-Q Sink Faucet

- Cast Brass Bar/Laundry Faucet on 4" centers
- 4-3/32 Rigid Gooseneck with GPM aerator
- 4" Wrist Blade Handles
- Polished chrome finish.
- Replaceable seats.
- Quick-Pression Quarter-Turn Stems
- NOTE: Thickness of sink or countertop cannot exceed 1/8"

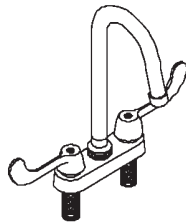

Part #	Description	Price
05013040	0084-GSAELS-Q 4 CC Sink Faucet WB Hdl Rigid GN Spout	152.00

0084-GRA-Q Sink Faucet

- Cast Brass Bar/Laundry Faucet on 4" centers
- 4-3/32 Rigid Gooseneck with GPM aerator
- Polished chrome finish.
- Replaceable seats.
- Quick-Pression Quarter-Turn Stems
- NOTE: Thickness of sink or countertop cannot exceed 1/8"

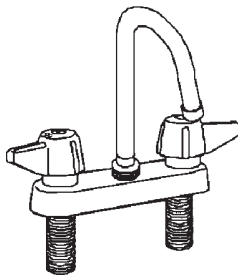

Part #	Description	Price
05013035	0084-GRA-Q 4 Sink Faucet Rigid GN Spout	110.00

0084-A-Q Laundry Faucet

- Cast Brass Bar/Laundry Faucet on 4" centers
- 6-inch tube spout with 2.2 GPM aerator
- Polished chrome finish.
- Replaceable seats.
- Quick-Pression Quarter-Turn Stems
- NOTE: Thickness of sink or countertop cannot exceed 1/8"

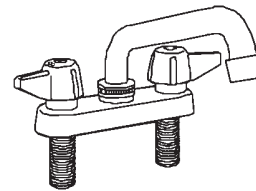

Part #	Description	Price
05013030	0084-A-Q 4 CC Laundry Faucet	112.00

0465 Laundry Tub Faucet

- Cast Brass Laundry Faucet on 3-1/2-inch centers
- 1/2-14 NPSF (Dryseal) female coupling union connections
- 6-inch tube spout with hose end
- Straddle legs
- Rough brass finish

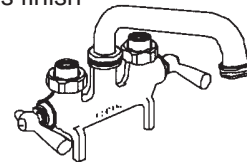

Part #	Description	Price
05013300	0465 3-1/2 CC Laundry Tub Faucet	62.00



CENBRASS-CENBRASS - Central Brass Faucets
RW List Prices - Page P-55

1131/1132 Shampoo Faucet

- Cast Brass Shampoo Faucet on 3 or 4-inch centers
- 1/2-14 NPS male shanks x 1 7/8-inches long
- 35° bottom outlet supply tube
- Replaceable seats.

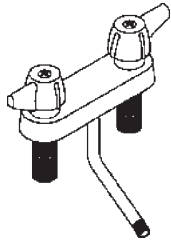

Part #	Description	Price
05013305	1132-B 3-3/8 CC Shampoo Faucet	108.00
05013310	1131-B 4 CC Shampoo Faucet	98.00

1137-AELS-Q Lav Faucet WB Hdl less PU

- Cast Brass Centerset on 4-inch centers
- 4-inch brass wrist handles
- Color-coded indexes
- 2.2 GPM aerator
- Replaceable seats
- Quick-Pression quarter-turn stems

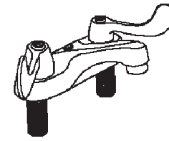

Part #	Description	Price
05013405	1137-AELS-Q 4 CC Lav Faucet WB Hdl less PU	138.00

1137-DA-Q Lav Faucet w/PU

- Cast Brass Centerset on 4" centers
- 2.2 GPM aerator
- Replaceable seats
- Pop-up drain
- Quick-Pression quarter-turn stems

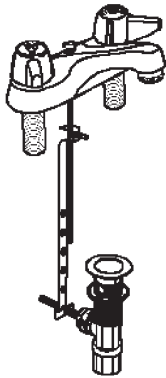

Part #	Description	Price
05013400	1137-DA-Q 4 CC Lav Faucet w/PU	124.00

CENBRASS-CENBRASS - Central Brass Faucets
Page P-56 - RW List Prices

1167-AV Self Closing Lav Faucet

- Self-Closing Cast Brass Centerset on 4" centers
- (Vandal-Resistant handles) with 2.2 GPM aerator
- Replaceable seats

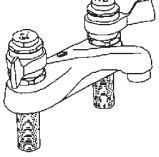

Part #	Description	Price
05013410	1167-AV 4 CC Self Closing Lav Faucet less PU	244.00

Central Brass Mfg Co

Not many companies can say they've been in business for over a century. But not many companies are like Central Brass. The brass faucets and fixture fittings we started making in 1895 are still made the same way today, with a combination of quality craftsmanship, rugged components and naturally, bodies cast of solid brass.

Today, Central Brass "trouble free" faucets and fixture fittings are the preferred choice among professional plumbing contractors for their long lasting design, durability and proven dependability.

Central Brass faucets feature solid cast brass bodies, ceramic or compression stems, easy to clean triple chrome finish and easy to get replacement parts. And, faucets for use in drinking water systems meet rigid standards for safety.

Plumbers install Central Brass because they know it's there to stay. They stake their reputation on it. They know it will keep on working and reduce dreaded call backs. Dependability and durability are the central ideas behind Central Brass. Because caring about how well a faucet functions is central to our way of thinking. Which means we'll probably be around for another 100 years.

1177-DA Shelf Back Lav Faucet W/PU

- Shelf Back with Cast Brass Bodies
- Adjustable centers from 4 to 6"
- 2.2 GPM aerator
- Replaceable seats
- Pop-up drain

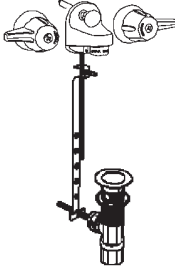

Part #	Description	Price
05013415	1177-DA 4-6 CC Shelf Back Lav Faucet w/PU+G50	176.00

1178-DA Slant Back Lav Faucet W/PU

- 45° Slant Back with Cast Brass Bodies
- Adjustable centers from 4 to 6"
- 2.2 GPM aerator
- Replaceable seats
- Pop-up drain

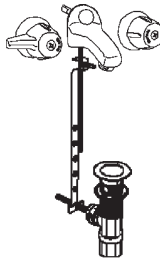

Part #	Description	Price
05013420	1178-DA 4-6 CC Slant Back Lav Faucet w/PU	230.00



CENBRASS-CENBRASS - Central Brass Faucets
RW List Prices - Page P-57

0239 1 Hole Basin Faucet

- Cast Brass
- 1/2 - 14 NPS male shank x 2-1/4" long
- Polished chrome finish
- Replaceable seat



Part #	Description	Price
05013500	0239-H 1 Hole Hot Basin Faucet	60.00
05013505	0239-C 1 Hole Cold Basin Faucet	60.00

0255 1 Hole Self Closing Basin Faucet

- 1/2-14 NPS male shank x 2 1/4" long
- Polished chrome finish
- Replaceable seat



Part #	Description	Price
05013510	0255-H 1 Hole Hot Self Closing Basin Faucet	116.00
05013515	0255-C 1 Hole Cold Self Closing Basin Faucet	116.00

0355-AV 1 Hole Self Close VR Basin Faucet

- 1/2-14 NPS male shank x 2 1/4" long
- 2.2 GPM aerator
- Vandal-resistant 0.5 GPM flow restrictor



Part #	Description	Price
05013520	0355-AV-H 1H Hot Self Closing VR Basin Faucet	136.00
05013525	0355-AV-C 1H Cold Self Closing VR Basin Faucet	136.00

0006-H1/2 1 Hole WM Hose End Basin Faucet

- Cast Brass Wall Mount
- 1/2-14 NPT male shank
- Adjustable flange, hose end
- Rough chrome finish
- Replaceable seat



Part #	Description	Price
05013530	0006-H1/2H 1H Hot WM Hose End Basin Fct	58.00
05013535	0006-H1/2C 1H Cold WM Hose End Basin Fct	58.00

0007-H1/2 1 Hole WM Threaded Basin Faucet

- Cast Brass Body with solid flange
- 1/2-14 NPS female threads, with hose end
- 4-arm handle
- Polished chrome finish
- Replaceable seat



Part #	Description	Price
05013540	0007-H1/2 1 hole WM Plain End Basin Faucet	70.00

0031-H1/2 WM Self Close Basin Faucet With Hose End

- Self-Closing Wall Mount
- 1/2-14 NPT male inlet shank
- 3/4-inch hose thread on outlet
- 4-arm handle
- Rough chrome finish
- Replaceable seat

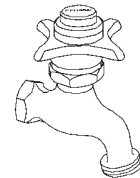

Part #	Description	Price
05013545	0031-H1/2H Hot WM Self Close Hose End Basin Faucet	98.00
05013550	0031-H1/2C Cold WM Self Close Hose End Basin Faucet	98.00

CENBRASS-CENBRASS - Central Brass Faucets
Page P-58 - RW List Prices

SU-363-RA 8 Swivel Tube Spout

- 8" Swivel Tube Spout with aerator

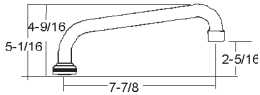

Part #	Description	Price
05013600	SU-363-RA 8 Swivel Tube Spout	34.00

SU-363-JA 10 Swivel Tube Spout

- 10" Swivel Tube Spout with aerator

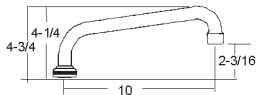

Part #	Description	Price
05013605	SU-363-JA 10 Swivel Tube Spout	42.00

SU-363-LA 12 Swivel Tube Spout

- 12" Swivel Tube Spout with aerator

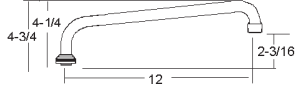

Part #	Description	Price
05013610	SU-363-LA 12 Swivel Tube Spout	46.00

SU-363-MA 14 Swivel Tube Spout

- 14" Swivel Tube Spout with aerator

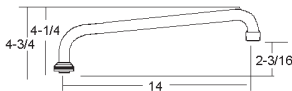

Part #	Description	Price
05013615	SU-363-MA 14 Swivel Tube Spout	46.00

SU-2775-R-02 7 Cast Brass Spout Extension

- Double-Joint Swing Spout
- 7-inch C to C
- Heavy cast brass construction
- Ideal for three compartment sinks
- Polished chrome finish

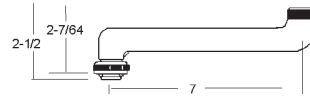

Part #	Description	Price
05013620	SU-2775-R-02 7 Cast Brass Spout Extension	76.00

SU-2923-A 5 Cast Brass Swivel Spout

- 5" Cast Brass Swivel Spout with aerator

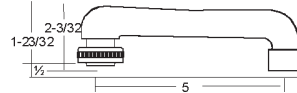

Part #	Description	Price
05013625	SU-2923-A 5 Cast Brass Swivel Spout	82.00



**CENBRASS-CENBRASS - Central Brass Faucets
RW List Prices - Page P-59**

SU-157-GSA 4-3/32 Swivel GN Spout

- 4-3/32" Swivel Gooseneck Spout with aerator

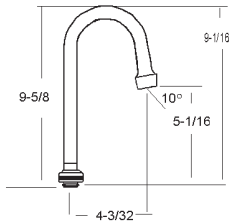

Part #	Description	Price
05013630	SU-157-GSA 4-3/32 Swivel GN Spout	42.00

SU-257-TSA 6-3/8 Tri Arc Swivel GN Spout

- 6-3/8" Swivel Tri-Arc Gooseneck Spout with aerator

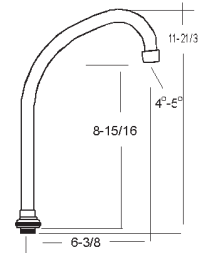

Part #	Description	Price
05013640	SU-257-TSA 6-3/8 Tri Arc Swivel GN Spout	106.00

SU-157-KSA 5-1/2 Swivel GN Spout

- 5-1/2" Swivel Gooseneck Spout with aerator

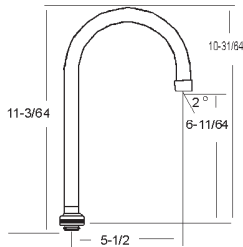

Part #	Description	Price
05013635	SU-157-KSA 5-1/2 Swivel GN Spout	98.00

SU-357-HSA 7-1/4 Hi Rise Swivel GN Spout

- 7-1/4" Swivel High Rise Spout with aerator

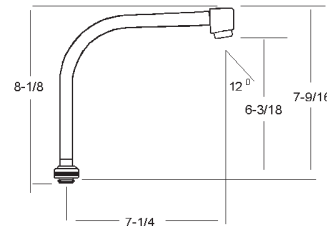

Part #	Description	Price
05013645	SU-357-HSA 7-1/4 Hi Rise Swivel GN Spout	140.00

SU-357WSA 8-3/4 Waterfall Swivel GN Spout

- 8-3/4" Swivel Gooseneck Spout with aerator

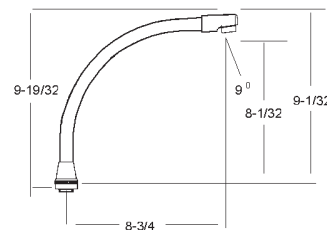

Part #	Description	Price
05013650	SU-357-WSA 8-3/4 Waterfall Swivel GN Spout	126.00

CENBRASS-CENBRASS - Central Brass Faucets
Page P-60 - RW List Prices

SU-157-GRA 4-3/32 Rigid GN Spout

- 4-3/32" Rigid Gooseneck Spout with aerator

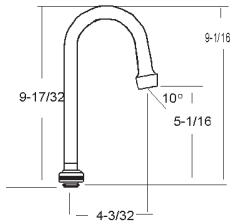

Part #	Description	Price
05013655	SU-157-GRA 4-3/32 Rigid GN Spout	42.00

SU-157-KRA 5-1/2 Rigid GN Spout

- 5-1/2" Rigid Gooseneck Spout with aerator

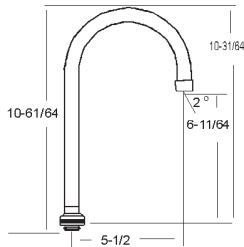

Part #	Description	Price
05013660	SU-157-KRA 5-1/2 Rigid GN Spout	98.00

Spout Adapter



Part #	Description	Price
05013700	xPF-784-C Hose Adapter for Spout	10.50

Wrist Blade Handles

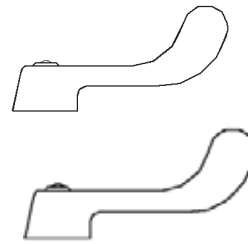

Part #	Description	Price
05013705	G-4147-C 4 Wrist Blade Handle	38.78
05013710	G-4147-H 4 Wrist Blade Handle	38.78
05013715	G-4149-C 6 Wrist Blade Handle	43.50
05013720	G-4149-H 6 Wrist Blade Handle	43.50

Wall Mount Swivel Spout Adapter

- Allows for topmount faucets to be mounted on splash back



Part #	Description	Price
05013750	G-1748-88W WM adapter	48.58



**CENBRASS-CENBRASS - Central Brass Faucets
RW List Prices - Page P-61**

6076 6 T&S Valve

- Cast Brass Body Assembly with twin ell
- 3/4-inch IPS diverter spout
- Shower head, arm and flange

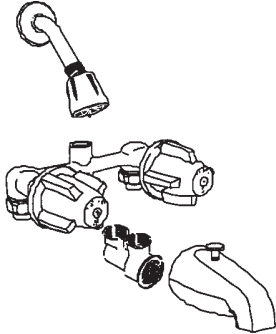

Part #	Description	Price
05013800	6076 6 CC 2 Valve T&S	158.00

0971-Z 11 3 Valve T&S

- Cast Brass Body Assembly with 1/2" IPS Zamak spout
- Shower head, arm and flange

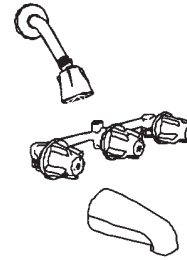

Part #	Description	Price
05013815	0971-Z 11 CC 3 Valve T&S	198.00

0968-Z 8 3 valve T&S

- Cast Brass Body Assembly with 1/2" IPS Zamak spout
- Shower head, arm and flange

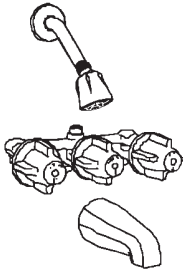

Part #	Description	Price
05013810	0968-Z 8 CC 3 Valve T&S	170.00

0477 Tall Utility Shower

- Utility Shower with cast brass body
- 3 1/2" centers 22-1/2" high galvanized riser
- Shower head and Soap dish
- 1/2 - 14 NPSF (Dryseal) female union
- Rough brass finish

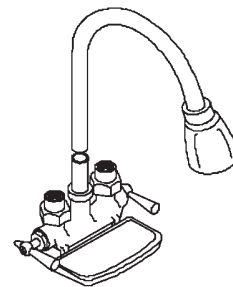

Part #	Description	Price
05013820	0477 3-1/2 CC 22-1/2 tall Utility Shower	116.00

CENBRASS-CENBRASS - Central Brass Faucets
Page P-62 - RW List Prices

0211 Leg Tub Faucet

- Leg Tub Fitting with 3/4-14 NPS male inlet arms
- Adjustable centers from 2-1/2-to 8-1/2"
- Top handles and polished chrome finish
- Replaceable seats.

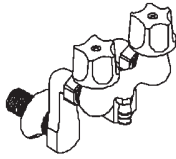

Part #	Description	Price
05013825	0211 2-1/2 -8-1/2 CC Leg Tub Faucet	234.00

0331-1/2 Self Closing Straight Stop

- Self-Closing Straight Stop with 1/2-14 NPS female thread
- 4-arm handle and polished chrome finish
- Replaceable seat

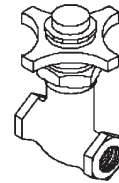

Part #	Description	Price
05013900	0331-1/2 Self closing Straight Stop	104.00

0335-1/2 Self Closing Shower Stop&Chain

- Self-Closing Cast Brass Shower Stop 1/2-14 NPS
- Replaceable seat
- Pull chain

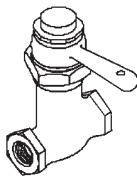

Part #	Description	Price
05013830	0335-1/2 Self Closing Shower Stop w/PULL chain	114.00

0333-1/2 Self Closing Angle Stop

- Self-Closing Angle Stop with 1/2-14 NPS female thread
- 4-arm handle and polished chrome finish
- Replaceable seat



Part #	Description	Price
05013905	0333-1/2 Self Closing Angle Stop	100.00

G-2092-PG Cover Plate

- 6-inch Brass Escutcheon plate with rubber gasket



Part #	Description	Price
05013835	G-2092-PG cover plate	26.18



**CENBRASS-CENBRASS - Central Brass Faucets
RW List Prices - Page P-63**

0336-1/2 Slow Closing Straight Stop

- Slow-Close Straight Stop with 1/2-14 NPS female thread
- Vandal-resistant handle
- External cycle adjustment
- Polished chrome finish

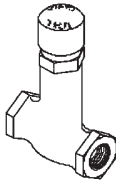

Part #	Description	Price
05013910	0336-1/2 Slow Closing Straight Stop	102.00

0360 Bubbler Head w Push Button

- Cast Brass Bubbler Head
- 1/2-14 NPS male shank
- Flange with replaceable cartridge (K-361)
- Polished chrome finish

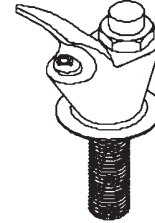

Part #	Description	Price
05014005	0360 Bubbler Head w Push Button	120.00

0342-1/2 Stand Pipe

- Stand Pipe with nut and flange with 1/2-14 NPT taper thread
- Polished chrome finish

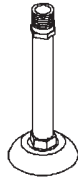

Part #	Description	Price
05013915	0342-1/2 Stand Pipe	29.18

0364-L Deck Mount Drinking Fountain

- Cast Brass Drinking Faucet
- 1/2-14 NPS male shank
- Self-closing lever handle
- Polished chrome finish
- Replaceable seat

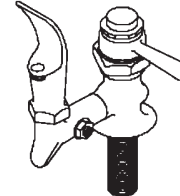

Part #	Description	Price
05014010	0364-L Deck Mount Drinking Fountain	204.00

0376 Bubbler Head only

- Cast Brass Drinking Faucet Head, 3/8-18 NPS
- Female thread
- Polished chrome finish (without stream control)



Part #	Description	Price
05014000	0376 Bubbler Head only	56.00

CENBRASS-CENBRASS - Central Brass Faucets
 Page P-64 - RW List Prices

0366-HX8 WM Drinking Fountain w/ Bowl

- Cast Brass Wall Mount Drinking Fountain with brass, brush finish round bowl
- 3/8-18 NPS female threads
- Self-closing lever handle
- Polished chrome finish
- Replaceable seat

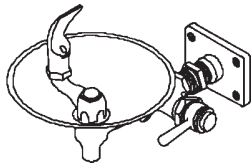

Part #	Description	Price
05014020	0366-Hx8 WM Drinking Fountain w/Bowl	324.00

K-352 Ceramic Cartridge

- Ceramic-disc Stem Cartridge Cold Side with Gasket (X1028-Y)
- Ceramic-disc Stem Cartridge Hot Side with Gasket (X1028-Y)



Part #	Description	Price
05014120	K-352-C Cold Ceramic Cartridge	39.30
05014125	K-352-H Hot Ceramic Cartridge	39.30

K-453 Std Compression Stem

- Cold Side Stem Assembly with Gasket(G-453-EL) & Seat(X263-BC)
- Hot Side Stem Assembly with Gasket(G-453-ER) & Seat(X263-BC)



Part #	Description	Price
05014100	K-453-C Std Cold Compression Stem	16.50
05014105	K-453-H Std Hot Compression Stem	16.50

G-454 Quickpression Stem

- Quick-Pression Quarter-Turn Cold Side Stem assembly with Gasket (X1028-Y)
- Quick-Pression Quarter-Turn Hot Side Stem assembly with Gasket (X1028-Y)



Part #	Description	Price
05014110	G-454-EL Cold Quickpression Stem	13.98
05014115	G-454-ER Hot Quickpression Stem	13.98



SLOAN-Sloan Flush Valves & Faucets
RW List Prices - Page P-65

Royal® Closet Flushometer
1-1/2" Top Spud

- Premium Flushometer includes Dual-Filtered Fixed By-Pass Diaphragm, ADA Handle with Triple Seal Packaging, Vandal Resistant Stop Cap, Vacuum Breaker Flush Connection & Sweat Kit with Cast Set Screw Wall Flange as standard.
- Non-hold Open, no External Volume Adjustment.
- Fixed Volume Accuracy w/CID® Technology.

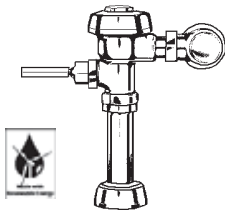

Part #	Description	Price
05485024	3010000 111, 1.6 Gal Flush Valve	220.00
05460305	3910168 111-1.28 1.28 Gal Flush Valve	220.00
05485040	3010100 110, 3.5 Gal Flush Valve	220.00
05485085	3010326 115-1.6, 1.6 Gal Flush	236.00
05485081	3010300 115, 3.5 Gal Flush Valve	236.00

Royal® Urinal Flushometer
3/4" Top Spud

- Quiet, Exposed Diaphragm Type, Urinal Flushometer
- Chrome Plated, Metal Oscillating Non-Hold-Open
- ADA Handle, Dual Filtered By-Pass Diaphragm
- 3/4" IPS Screwdriver Bak-Chek®,
- Angle Stop with Vandal Resistant Protective Cap,
- Adj. Tailpiece, Vacuum Breaker Flush Connection &
- Spud Coupling for 3/4" Top Spud,
- Wall & Spud Flanges

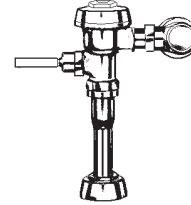

Part #	Description	Price
05485107	3012636 186-1 1 Gal Flush	220.00
05485206	3012600 186, 1.5 Gal Flush	220.00

Royal® Urinal Flushometer
1-1/4" Top Spud

- Quiet, Exposed Diaphragm Type, Urinal Flushometer
- Chrome Plated, Metal Oscillating Non-Hold-Open ADA Handle, Dual Filtered By-Pass Diaphragm
- 1" IPS Screwdriver Bak-Chek®,
- Angle Stop with Vandal Resistant Protective Cap,
- Adj. Tailpiece, Vacuum Breaker Flush Connection &
- Spud Coupling for 1-1/4" Top Spud,
- Wall & Spud Flanges

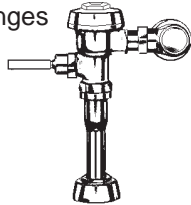

Part #	Description	Price
05485170	3012436 180-1, 1 Gal Flush Valve	220.00
05460310	3912697 186-0.5 5 Gal Flush Valve	220.00
05485164	3012400 180, 3 Gal Flush Valve	220.00
05486607	3012500 181, 3 Gal Flush Valve	224.00

Royal Slimline® Bedpan Wash Flushometer

- Quiet, Exposed Diaphragm Type, Closet Flushometer,
- Chrome Plated, Metal Oscillating Non-Hold-Open ADA Handle, Diverter Valve Assembly with Spray Arm Dual Filtered By-Pass Diaphragm,
- 1" IPS Screwdriver
- Bak-Chek® Angle Stop with Vandal Resistant Protective Cap, Adj. Tailpiece, Vacuum Breaker
- Flush Connection, Wall Support & Spud
- Coupling for 1-1/2" Top Spud, Wall Spud & Spud Flanges

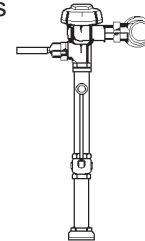

Part #	Description	Price
05490480	3019700 BPW-1000, 3.5 Gal Flush	670.00

SLOAN-Sloan Flush Valves & Faucets
Page P-66 - RW List Prices

Royal® Service Sink Flushometer

- Quiet, Exposed, Diaphragm Type, Chrome Plated
- Dual Filtered Fixed Bypass Diaphragm
- ADA Compliant Metal Oscillating Non-Hold-Open Handle with Triple Seal Handle Packing
- 1" I.P.S. Screwdriver Bak-Chek. Angle Stop
- Free Spinning Vandal Resistant Stop Cap
- Adjustable Tailpiece, High Back Pressure Vacuum Breaker
- Flush Connection with 1-piece Bottom Hex Coupling Nut
- Spud Coupling and Flange for 1½" Top Spud

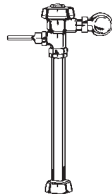

Part #	Description	Price
05485100	3010500 117, 6.5 Gal Flush	236.00

The inventor of the Flushometer and founder of Sloan Valve Company was born in Liberty, Missouri. After serving as an apprentice pipe fitter, he traveled to Chicago and became a foreman, a superintendent, and finally, an independent contractor. Through intense self-education, Mr. Sloan developed a superior knowledge of electrical circuitry and hydraulics, which led to a total of 64 inventions during his long, productive life. Among these were a relay booster for telegraph lines and a fire-safety curtain for theaters. The later invention was inspired by the Iroquois Theater fire in Chicago, which claimed hundreds of lives. The fire started backstage and spread rapidly into the auditorium. Mr. Sloan's conception was a fireproof curtain with heat fusible linkage, which would drop instantly and automatically in the event of a fire; it was simple, practical and, like most good inventions, immediately obvious-once somebody thinks of it.

Mr. Sloan then developed the idea for the Royal Flushometer with its revolutionary design and ingenious simplicity. The Royal is a diaphragm-type valve and was the original product of Sloan Valve Company when it started in business in 1906. It is still the largest selling

Flushometer in the Sloan line (literally millions are in use throughout the world). While there have been many refinements and improvements in component parts over the years, the working principle and fundamental hydraulic design have not changed. No figure in our industry ever faced a greater sales challenge than Mr. Sloan in launching his new company, and none ever persevered more courageously in the face of resistance and discouragement. The benefits of using Flushometers instead of toilet tanks in commercial structures were considerable and undeniable: a saving of water, much less maintenance; a relative freedom from breakage and vandalism, and virtually no recycling time between flushes. These benefits would pay every day for the life of the building. But to get them, you had to accept a somewhat higher initial cost because the pipe size of the branch line supplying the fixture had to be larger than that required for a toilet tank.

But the real problem Mr. Sloan had to overcome was the normal human resistance to change. Plumbers were afraid to install Flushometers because they knew nothing about them. Architects would not specify them for the same reason. Owners did not want to be the guinea pigs. Lenders were leery of unproven products. Some fixture manufacturers even refused to furnish their fixtures when Sloan Flushometers were to be installed.

The first year he sold one Flushometer - that's right, one! The next year he doubled his business and sold two. In the third year a phenomenal advance was made; he sold 150 Flushometers and from then on sales shot upward. Whenever a building engineer would permit, Mr. Sloan would install Royal Flushometer for demonstration, and let him see the savings and benefits for himself. The flush valve proved so incomparably better that the trade began to relax its opposition.

Mr. Sloan also developed piston-type Flushometers. Over the years, the original Royal was joined by the Star, the Crown, the Gem and the Naval; plus automatic urinal flushing systems and the Act-O-Matic showerhead. He made his product names bywords in the industry through powerful, consistent advertising in plumbing, architectural, and institutional publications, using cover positions whenever available.

Mr. Sloan died just short of his 93rd year. The company he founded and built is today the world leader in Flushometers. Its foundry and plants are among the most modern and efficient in the plumbing industry.



SLOAN-Sloan Flush Valves & Faucets
RW List Prices - Page P-67

Regal® Closet Flushometer
1-1/2" Top Spud

- Quiet, Exposed Diaphragm Type, Closet Flushometer
- Chrome Plated, Metal Oscillating Non-Hold-
- Open ADA Handle, 1" IPS Screwdriver Bak-Chek® Angle Stop, Adjustable
- Tailpiece, Vacuum Break Flush Connection & Spud Coupling for 1-1/2" Top Spud, Wall & Spud Flanges

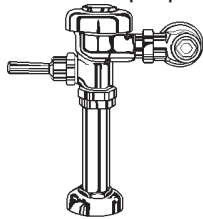

Part #	Description	Price
05487000	3080053 111-XL, 1.6 Gal Flush	148.00
05487010	3080153 110-XL, 3.5 Gal Flush	148.00

Regal® Urinal Flushometer
3/4" Top Spud

- Quiet, Exposed Diaphragm Type, Urinal Flushometer
- Chrome Plated, Metal Oscillating Non-Hold-
- Open ADA Handle, 3/4" IPS Screwdriver Bak-Chek® Angle Stop, Adjustable Tailpiece, Vacuum Break Flush Connection & Spud Coupling for 3/4" Top Spud, Wall & Spud Flanges

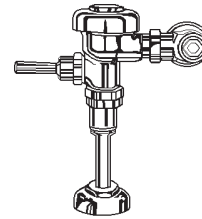

Part #	Description	Price
05487030	3082675 186-1XL, 1.0 Gal Flush	148.00
05487020	3082653 186-XL, 1.5 Gal Flush	148.00

Regal® Urinal Flushometer
1-1/4" Top Spud

- Quiet, Exposed Diaphragm Type, Urinal Flushometer
- Chrome Plated, Metal Oscillating Non-Hold-
- Open ADA Handle, 1" IPS Screwdriver Bak-Chek®
- Angle Stop, Adjustable Tailpiece, Vacuum Break Flush Connection & Spud Coupling for 1-1/4" Top Spud, Wall & Spud Flanges

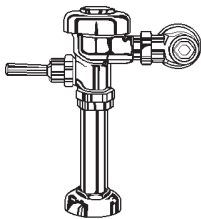

Part #	Description	Price
05487070	3250020 180-1XL, 1 Gal Flush	148.00

SLOANPTS-Sloan Parts
Page P-68 - RW List Prices
Royal® & Regal® Flushometer Parts

Royal® Performance Kits



Part #	Description	Price
99504500	3301150 A1101A-BX 1.6 Closet Kit	49.78
99504510	3301151 A1102A-BX 3.5 Closet Kit	49.78
Part #	Description	Price
99504525	3301153 A1106A-BX .5 Urinal Kit	49.78
99504520	3301154 A1107A-BX 1.0 Urinal Kit	49.78
99504530	3301155 A1108A-BX 1.5 Urinal Kit	49.78

Royal® Diaphragm Kits



Part #	Description	Price
99504390	3301122 A1041A-BX 1.6 Closet Dual Filter Kit	42.50
99504380	3301121 A1038A-BX 3.5 Closet Dual Filter Kit	42.50
Part #	Description	Price
99504410	3301124 A1043A-BX .5 Urinal Dual Filter Kit	42.50
99504400	3301123 A1042A-BX 1.0 Urinal Dual Filter Kit	42.50
99504370	3301500 A1037A 1.5 Urinal Dual Filter Kit	42.50

Regal® Diaphragm Kits



Part #	Description	Price
99505120	3301041 A-41-A 1.6 Regal Closet Kit	26.78
99505117	3301038 A-38-A 3.5 Regal Closet Kit	19.58
99505000	3301036 A-36-A 4.5 Regal Closet Kit	19.58
Part #	Description	Price
99505130	3301081 A-43-A 0.5 Regal Urinal Kit	26.78
99505125	3301044 A-42-A 1.0 Regal Urinal Kit	26.78
99505109	3301037 A-37-A 1.5 Regal Urinal Kit	19.58

Discs, Diaphragms, Guides



A-56-AA

Part #	Description	Price
99505505	5301111 A-15-A Molded Disc for All Inside Parts Kits	9.58
99505802	5301170 A-56-A Diaphragm with A-29-Old Style Pre-1965	10.90
99505851	5301176 A-56-AA Diaphragm Rep Kit with A-29 Old Style Pre-1965	21.30
99505901	5301188 A-156-A Regal Diaphragm	11.30
99506008	5301189 A-156-AA Regal Diaphragm Repair Kit	19.50
99506057	5301236 A-163-A Guide	9.18

Covers



A-72 A-71

Part #	Description	Price
99505752	0301168 A-71 Inside Cover	13.10
99505755	0301172 A-72 CP Outside Cover	36.10

Relief Valves



Part #	Description	Price
99505158	5301058 A-19-AC Closet Relief Valve	11.30
99505208	5301059 A-19-AU Urinal Relief Valve	11.30
99505210	0301178 A-19-ALCM Brass Metal Relief Valve	23.18



**SLOANPTS-Sloan Parts
RW List Prices - Page P-69**

Spud Assembly



Part #	Description	Price
99506552	0306092 F-2-A 1-1/2 Coupling	13.78
99506495	5306055 F-3 3/4 Friction Ring	0.78
99506498	5306057 F-3 1-1/4 Friction Ring	0.78
99506520	5306058 F-3 1-1/2 Friction Ring	0.78
99506781	5307071 G-44 1-1/2 Friction Ring	1.58
99506602	5306113 F-5 3/4 SJ Gasket	1.58
99506670	0306125 F-5-A 3/4 CP Coupling Assy	23.50
99506681	0306140 F-5-A 1-1/4 CP Coupling Assy	23.50
99506701	0306146 F-5-A 1-1/2 CP Spud Coupling Assy	23.50
99506750	0306214 F-7 1-1/4 CP Spud Flange	10.98
99506732	0306238 F-7 1-1/2 CP Spud Flange	10.98
99506763	0306516 F-20-A 3/4 CP Spud Coupling Nut	15.50

Vacuum Breaker



Part #	Description	Price
99508459	3322079 V-101-A Vacuum Breaker Repair Kit	19.98
99508707	5323010 V-500-A Vacuum Breaker	35.10
99508509	5323005 V-500-AA 3/4x9 Vacuum Breaker	35.10
99508445	0323004 V-500-AA 3/4x10-1/2 Vacuum Breaker	48.70
99508450	0323210 V-500-AA 3/4x15 Vacuum Breaker	61.10
99508558	5323006 V-500-AA 1-1/4x9 CP Vacuum Breaker	35.10
99508608	5323007 V-500-AA 1-1/2x9 CP Vacuum Breaker	35.10
99508855	0323015 V-500-AA 1-1/2 x 21 CP Vacuum Brk	58.50
99508860	0323016 V-500-AA 1-1/2 x 24-1/2 CP Vac Brkr	65.78
99509002	3323192 V-551-A Vacuum Breaker Repair Kit	7.10
99509020	3323182 V-651-A High Press Vac Brkr Rep Kit	7.50
99508432	5322001 VBF-5 1-1/2 Vacuum Breaker Gasket	1.18

Handles



Part #	Description	Price
99505406	0301082 A-6 CP Handle Coupling	10.58
99505604	5301139 A-31 Handle Gasket	1.58
99506156	0302109 B-7-A CP Socket Assembly	11.58
99506255	5302274 B-32 CP Handle	14.10
99506305	5302279 B-32-A CP Handle Assembly	22.38
99506354	5302297 B-39 Seal	2.90
99506453	5302305 B-50-A Handle Repair Kit	7.90
99506456	3302306 B-51-A Triple Seal Permex® Handle Rep Kit	12.58
99506463	0302390 B-73-A CP ADA Handle Assembly	29.70

Dual-Flush Uppercut Retrofit Kit

- WES212-A: Dual-Flush Retrofit Handle for Exposed, Low Consumption Water Closet Flushometers
- WES213-A: Dual-Flush Retro Han and Dual Filtered Diaphragm Kit for Exposed Water Closet Flushometers



NOTE: Does not include complete Flushometer

99506470	3372003 WES212A Uppercut Retrofit Hdl Kit	79.78
99510385	3372004 WES213A Uppercut Retrofit Hdl Kit	113.10

SLOANPTS-Sloan Parts
Page P-70 - RW List Prices



Part #	Description	Price
99506799	0308606 H-534 1-3/8 x 6 CP Ext Sleeve to cover H-551-A longer tailpieces above	15.90
99507402	0308801 H-551-A CP 2-1/16 Adj Tailpiece	23.70
99507501	0308803 H-551-A 3-1/16 Tailpiece	29.70
99507535	0308805 H-551-A 4-1/16 Tailpiece	33.18



Part #	Description	Price
99506795	3308277 H-47-AA Screw Driver Stop Repair Kit	50.70
99506800	5308696 H-553 O Ring	2.58
99509275	5308381 H-552 Lock Ring	1.98
Part #	Description	Price
99507600	3308853 H-541-A Control Stop Repair Kit	17.38
99507620	3308856 H-543-A Control Stop Repair Kit	17.38
99507020	3308384 H-700-A 3/4 Bak-Chek® Screwdriver Stop	85.38
99507030	3308386 H-700-A 1 Bak-Chek® Screwdriver Stop	85.38
99509260	3308385 H-700-AG 3/4 CP Stop	87.50
99509265	3308387 H-700-AG 1 CP Stop	87.50
99509270	3308389 H-750-AG 1 CP Stop	88.78
Part #	Description	Price
99506793	5308156 H-37 CP Regal Stop Cap	15.50
99507550	0308840 H-573-A Control Stop Cap CP	20.58
99507555	3308866 H-574 Ctrl Stop Cap with Bumper	19.30
99507584	0308848 H-582 Control Stop Cap CP	18.30
99507595	3308791 H-1010-A 1 VR Control Stop Cap	16.98
99507590	3308790 H-1009-A 3/4 VR Control Stop Cap	16.98

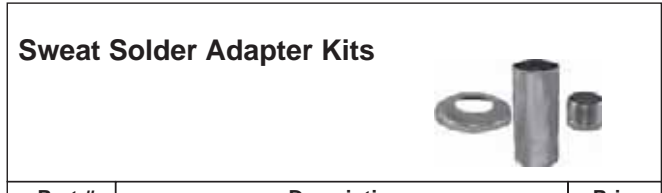

Part #	Description	Price
99507204	3308783 H-534-AS 1 SWT Kit W/6 Casing	16.10
99507303	3308786 H-536-AS 3/4 SWT Kit	16.10
99507390	3308788 H-636-AA 3/4 SWT Kit W/Cast Set Screw Flange	16.10

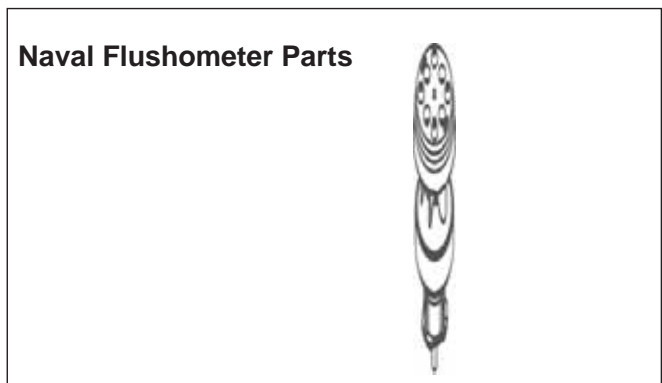

Part #	Description	Price
99507907	0314179 CN-15-A Top Plate	15.30
99508350	0314234 CN-21-A Main Seat	17.38
99508004	5314236 CN-105-A Cover Gasket	2.58
99508301	5314226 CN-120 Relief Valve Seat	3.70
99507709	0314016 CN-1002-A Piston with Seat Closet	71.90
99507808	0314017 CN-1003-A Piston and Seat Urinal	71.90
99508426	5314094 CN-1004-A Crown Repair Kit	64.30
99508152	5319046 S-14-A Molded Cup	9.18
99508202	5319049 S-14-AA Piston Repair	21.90



**SLOANPTS-Sloan Parts
RW List Prices - Page P-71**



Part #	Description	Price
99500100	0307195 G-1016-A 1.6 Gal WC Gem Piston Kit	47.58
99500110	0307133 G-1018-A .5 Gal Urin Gem Piston Kit	47.58
99500105	0307185 G-1017-A 1.0 Gal Urin Gem Piston Kit	47.58
Part #	Description	Price
99500115	5307074 G-50-A Gem Handle Repair Kit	11.58
99509280	0307100 G-143-A GEM Handle Assy	35.98



Part #	Description	Price
99515000	C-100500-K Flushmate Cartridge Kit	39.10
99515100	BU100505-K Flushmate Upper Kit	13.10
99515200	BL100504-K Flushmate Lower Kit	48.18
99515300	RK100100 Flushmate Supply Group	60.58
99515305	B108288 Flushmate Duckbill Valve	2.18



Part #	Description	Price
99500007	0310083 J-212-A 1-1/2 x 5 Pipe Support	51.38
05484114	0310087 J-212-A 1-1/2 x 6 Pipe Support	54.98



Part #	Description	Price
99505751	0301255 A-50 Wrench	63.50

TOTO®

Reeves-Wiedeman Company
PLUMBING SUPPLIES FOR CONTRACTORS AND INDUSTRY



TOTOPTS-Toto Parts
Page P-72 - RW List Prices

Manual Flush Valve Repair Parts For
TMU1NNC-12 or TMT1NNC-32

TOTO®

Part #	Description	Price
14202695	TH323V102 Toto 1.0 Piston Assembly	74.30
14202690	TH323V100 Toto 1.6 Piston Assembly	72.90
14202680	THY305S Toto Lever Assembly	56.98

Reeves-Wiedeman Company

Emporia, Ks	Grandview, Mo	Independence, Mo	KCMO-Downtown	KCMO-Midtown	KCMO-Waldo	Lawrence, Ks	Junction City, Ks	Leavenworth, Ks
Liberty, Mo	Lees Summit, Mo	Lenexa, Ks	Manhattan, Ks	Maryville, Mo	Olathe, Ks	Riverside, Mo	Saint Joseph, Mo	Topeka, Ks

Shaded Items are Non-Stock



AUTOMATIC-FV-Automatic Flushvalves
RW List Prices - Page P-73

**Sloan G2 Optima Plus® Flushometer
1-1/2" Top Spud**

- Battery-Powered Sensor Operated Control Module and Flex-Tube Diaphragm Flushometer
- Includes Angle Stop, Vacuum Breaker Flush Connection, Sweat Solder Kit with Cover Tube and Cast Set Screw Wall Flange
- For Exposed Flushometer for 1-1/2" Top Spud Bowls



SLOAN 

Part #	Description	Price
05450545	3250289 G-2 8111-1.28 Flush Valve	660.00
05460210	3250400 G-2 8111 1.6 Gal Flush Valve	660.00
05460240	3250404 G-2 8110 3.5 Gal Flush Valve	660.00

**Sloan G2 Optima Plus® Flushometer
3/4" Top Spud**

- Battery-Powered Sensor Operated Control Module and Flex-Tube Diaphragm Flushometer
- Includes Angle Stop, Vacuum Breaker Flush Connection, Sweat Solder Kit with Cover Tube and Cast Set Screw Wall Flange
- For Exposed Flushometer for 3/4" Top Urinals.



SLOAN 

Part #	Description	Price
05460220	3250401 G-2 8186-1 1.0 Gal Flush Valve	660.00
05460230	3250403 G-2 8186 1.5 Gal Flush Valve	660.00

**Sloan G2 Optima Plus® Flushometer
1-1/4" Top Spud**

- Battery-Powered Sensor Operated Control Module and Flex-Tube Diaphragm Flushometer
- Includes Angle Stop, Vacuum Breaker Flush Connection, Sweat Solder Kit with Cover Tube and Cast Set Screw Wall Flange
- For Exposed Flushometer for 1-1/4" Top Urinals.



SLOAN 

Part #	Description	Price
05460250	3250406 G-2 8180-1 1 Gal Flush Valve	660.00
05460260	3250408 G-2 8180 3.5 Gal Flush Valve	660.00

AUTOMATIC-FV-Automatic Flushvalves
Page P-74 - RW List Prices

Sloan ECOS® Dual Flushometer
1-1/2" Top Spud

- Exposed, Battery-Powered Sensor Operated Sloan ECOS® Control Module with Smart Sense Technology™
- Electronic Dual-Flush and Flex-Tube Diaphragm Flushometer
- Includes Angle Stop, Vacuum Breaker Flush Connection, Sweat Solder Kit with Cover Tube and Cast Set Screw Wall Flange
- Supplied less Handle Opening and with Metal Cover
- For 1-1/2" Top Spud Water Closets



Part #	Description	Price
05450520	3370400 ECOS 8111-1.6/1 Dual Flush Valve	670.00

Sloan SOLIS® Flushometer 1-1/2" Top Spud

- Exposed, Solar-Powered Sensor Activated Sloan SOLIS® Flushometer
- Includes Angle Stop, Vacuum Breaker Flush Connection, Sweat Solder Kit with Cover Tube and Cast Set Screw Wall Flange
- Supplied less Handle Opening and with Metal Cover
- Includes infrared sensor with multiple-focused, lobular sensing fields for high and low target detection
- (4) "AA" battery backup power source



Part #	Description	Price
05450550	3370002 SOLIS 8111-1.28 Flush Valve	688.00

Sloan SOLIS® Dual Flushometer
1-1/2" Top Spud

- Includes Angle Stop, Vacuum Breaker Flush Connection, Sweat Solder Kit with Cover Tube and Cast Set Screw Wall Flange
- Supplied less Handle Opening and with Metal Cover
- Includes infrared sensor with multiple-focused, lobular sensing fields for high and low target detection
- (4) "AA" battery backup power source – for Exposed Flushometer with 1-1/2" Top Spud Bowls.



Part #	Description	Price
05450510	3370000 SOLIS DF 8111-1.6/1 Dual Fish Vlv	688.00

Sloan SOLIS® Flushometer 3/4" Top Spud

- Exposed, Solar-Powered Sensor Activated Sloan SOLIS® Flushometer
- Includes Angle Stop, Vacuum Breaker Flush Connection, Sweat Solder Kit with Cover Tube and Cast Set Screw Wall Flange
- Supplied less Handle Opening and with Metal Cover
- Includes infrared sensor with multiple-focused, lobular sensing fields for high and low target detection
- (4) "AA" battery backup power source



Part #	Description	Price
05450515	3370006 Solis 8186-1.0 Flush Valve	688.00



AUTOMATIC-FV-Automatic Flushvalves
RW List Prices - Page P-75

Toto EcoPower® Flushometer 1-1/2" Top Spud

- EcoPower toilet flushometer valve top spud - exposed model
- 1.6 Gpf. Neutral rough-in
- ADA compliant.
- Nickel Chrome Plated finish.



TOTO®

Part #	Description	Price
14220010	TET1GNC-32 EcoPower 1.6 Gal Flush Valve	734.00

Sloan Side Mount Operator Retrofit Kit

- Programmable automatic flushing systems,
- Sensor-operated for touch-free performance
- Tempered Glass lens, adjustable infrared sensing
- Low battery light notification
- Courtesy flush button
- Standard "C" batteries supplied
- Install in 2 minutes or change batteries with no water shut off required

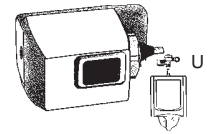
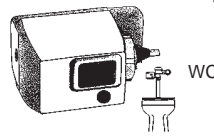

Part #	Description	Price
05485350	0325105 EBV-89A-M WC Kit W/Metal Cover	288.00

Toto EcoPower® Flushometer 3/4" Top Spud

- Electronic urinal flushometer valve complete with 3/4" angle stop and 3/4" vacuum breaker set. Hydro-powered, Top spud – exposed.
- Low consumption, 1.0 Gpf or less.
- Manual override.
- Neutral rough-in,
- ADA compliant.
- 24 hour flush.
- Piston valve action.
- Nickel Chrome Plated Finish.
- Three Year Limited Warranty



TOTO®

Part #	Description	Price
14220000	TEU1GNC-12 EcoPower 1.0 Gal Flush Valve	734.00

Sloan Optima® SMOOTH® Retrofit Kit

- Sloan SMOOTH™ works out of the box. Simply slide the unit over the Flushometer handle and tighten the clamp. Within minutes, the Sloan SMOOTH™ converts many Manual Flushometers to Sensor Activated.
- ADA Compliant OPTIMA® SMOOTH™ Battery Powered Infrared Sensor for automatic "Hands-free" operation
- Sensor with Automatic Range Adjustment
- Chrome Plated Metal Sensor Housing
- Mechanical Manual Override Flush Handle
- Four (4) Size C Batteries included
- "Low Battery" Flashing LED
- "User in View" Flashing LED
- Installation requires use of a standard screwdriver



Part #	Description	Price
05485405	3325201 EBV-200-A Smooth Sidemount Kit	316.00

AUTOMATIC-FV-Automatic Flushvalves
Page P-76 - RW List Prices

Sloan G2 RESS Optima Plus® Retrofit Kit



Part #	Description	Price
05460270	3325400 G-2 RESS-C Closet Retrofit Kit	506.00
05460280	3325402 G-2 RESS-U Urinal Retrofit Kit	506.00

Sloan SOLIS® RESS Retrofit Kit



RESS-C

Part #	Description	Price
05450540	3375302 SOLIS RESS-C 1.28 Retrofit Kit	528.00
05450500	3375301 SOLIS RESS-C 1.6 Retrofit Kit	528.00

Sloan Optima Plus® to G2 Conversion Kit

- To convert Optima Plus to G-2



Part #	Description	Price
99509250	0325160 EBV-138-A G-2 Closet Converts Kit	504.00
99509255	0325161 EBV-139-A G2 Urinal Conversion Kit	504.00

Sloan G-2 to SOLIS® Conversion Kit

- To convert G2 to SOLIS



EBV-1005-A

Part #	Description	Price
05450535	3375351 EBV-1005-A SOLIS Conversion Kit	376.00

Sloan ECOS® RESS Dual Flush Retrofit Kit



RESS-C-1.6/1/1

Part #	Description	Price
05450505	3375400 ECOS RESS-C-1.6/1/1 Retrofit Kit	518.00

Sloan G-2 to ECOS® Dual Flush Conversion Kit

- To convert G2 to ECOS



EBV-1004-A

Part #	Description	Price
05450530	3375450 EBV-1004-A ECOS Conversion Kit	248.00



Reeves-Wiedeman Company
PLUMBING SUPPLIES FOR CONTRACTORS AND INDUSTRY

AUTOMATIC-FV-Automatic Flushvalves
RW List Prices - Page P-77

Sloan Optima® Plus Parts		
Part #	Description	Price
99510350	0325176 EBV-146-AC Module Assembly	293.90
99510355	0325177 EBV-146-AU Module Assembly	293.90
99510101	0325804 EBV-14 Optima Locking Ring	37.70
99510260	3325055 EBV-1042-A Override PB Replace Kit	16.38
99510150	3325537 EBV-46-A Optima Deflector	11.70
99510128	0325814 EBV-21-A Inside Cover Assembly	135.38
99510125	5325813 EBV-18 Optima Quad Ring	1.90
99510365	3325462 EBV-144-A Old Style Solenoid	40.78

Sloan G-2 Optima® Plus Parts		
Part #	Description	Price
99510395	0325172 EBV-130-A Manual Override Button	44.78
99509290	3325450 EBV-129-A-C G2 Closet Mod Assy	209.90
99509295	3325451 EBV-129-A-U G2 Urinal Mod Assy	209.90
99510345	3325453 EBV-136-A Isolated Solenoid	40.78
99510330	3325001 EBV-1020-A Closet Kit (Flex Tube Diaphragm)	59.98
99510335	3325000 EBV-1022-A Urinal Kit (Flex Tube Diaphragm)	59.98

Sloan Optima® Strap Wrench		
Part #	Description	Price
99509230	0325823 EBV-22 Sloan Strap Wrench	11.50

Toto Automatic Flush Valve Repair Parts		
TOTO®		
Part #	Description	Price
14202685	TH321S Toto Seal Washer Kit	12.78
14202705	TH323V103R Toto 1.6 Piston Assy	68.58
14202710	TH323V104R Toto 1.0 & 3.5 Piston Assy	58.50
14202700	TH305SV103 Toto U-Packing	18.38

Sloan Optima® Hard Wired Sensor, Switch		
Part #	Description	Price
99509300	0305324 EL-141-A Override Switch Assembly	34.90
99510325	3305621 EL-1500-L Closet Sensor	267.38
99510315	3305620 EL-1500 Urinal Sensor	267.38

Sloan Optima® Hard Wired Solenoid Parts		
<p>IF EL-226 EXTENSION ADAPTER(S) ARE USED, INSERT BETWEEN NIPPLE AND SOLENOID HOUSING</p> <p>IMPORTANT: Do not remove coil from solenoid plunger guide unless power has been disconnected. Failure to do so may damage sensor, coil and transformer.</p>		
Part #	Description	Price
99509210	3305043 EL-128-A Cartridge Assembly	37.98
99509205	0305165 EL-163-A Solenoid Shaft Assembly	56.90
99509220	0305125 EL-101 Nut for Solenoid	28.78
99509200	0305118 EL-165-2 24 V Coil	30.10

Sloan Optima Transformer		
<ul style="list-style-type: none"> 120V 50VA 		
Part #	Description	Price
99510170	0345154 EL-154 Box Type Transformer	55.70

<i>Reeves-Wiedeman Company</i>								
Emporia, Ks	Grandview, Mo	Independence, Mo	KCMO-Downtown	KCMO-Midtown	KCMO-Waldo	Lawrence, Ks	Junction City, Ks	Leavenworth, Ks
Liberty, Mo	Lees Summit, Mo	Lenexa, Ks	Manhattan, Ks	Maryville, Mo	Olathe, Ks	Riverside, Mo	Saint Joseph, Mo	Topeka, Ks

Shaded Items are Non-Stock

AUTOMATIC-FAUCETS-Automatic Faucets
Page P-78 - RW List Prices

250 Sloan Battery Soap Dispenser

- Sensor Activated, Electronic, Chrome Plated Cast Brass Spout, Soap Dispenser
- Modular One-piece Construction
- Active Infrared Sensor
- Low Battery Indicator (Model ESD-250)
- Mounting Hardware included
- Low Soap Level Indicator
- Easy Loading Disposable Soap Refills
- New Pump and Delivery Tube with each Refill
- Unit supplied with one 800 ml. Container of Soap.
- 3 Yr warranty

SLOAN



Part #	Description	Price
05460300	3346050 ESD-250 Optima Soap Dispenser	548.00
99510370	0346017 ESD-217 Soap Cartridge	35.00

85 Sloan Optima® Plus Battery Lav Faucet

- ADA Compliant, Sensor Activated, Battery Powered, Chrome Plated Brass, Gooseneck Hand Washing Faucet
- 0.5 gpm/1.9 Lpm Vandal Resistant Spray Head
- Splash-proof Circuit Control Module
- Fiber Optic, Automatic, Self-adaptive Sensing
- Audible Tone Low Battery Indicator
- Serviceable Filtered Solenoid Valve
- Bak-Chek Tee for Hot/Cold Supply
- Trim Plate with Anti-Rotation Pin (specify 4" or 8")
- Vandal Resistant Spray Head with Pressure Compensating Flow Control
- Polypropylene Optic Cable Protection
- Includes four (4) C-cell Alkaline Batteries

SLOAN



Part #	Description	Price
05460150	3315010 EBF-85-4 Optima Lav Faucet	908.00

650 Sloan Optima® Plus Battery Lav Faucet

- ADA Compliant, Sensor Activated, Battery Powered, Chrome Plated 4. Center-set Cast Brass, Hand Washing Faucet
- 0.5 gpm/1.9 Lpm Vandal Resistant Spray Head
- Splash-proof Circuit Control Module
- Sensor Range Adjustment Screw
- Low Battery LED Indicator Light
- User friendly Variable Time Out Settings
- Serviceable Filtered Solenoid Valve
- Bak-Chek Tee for Hot/Cold Supply
- Vandal Resistant Spray Head with Pressure Compensating Flow Control
- Metal Jacketed Wire Protection for Sensor lead
- Includes four (4) C-cell Alkaline Batteries
- Appropriate Mounting Hardware included

SLOAN



Part #	Description	Price
05460125	3315025 EBF-650 Optima Lav Faucet	786.00

750 Sloan Optima® Plus Battery Gooseneck Faucet

- ADA Compliant, Sensor Activated, Battery Powered, Chrome Plated Brass, Gooseneck Hand Washing Faucet
- 2.2 gpm/8.3 Lpm Vandal Resistant Laminar Flow Spray Head
- Splash-proof Circuit Control Module
- Sensor Range Adjustment Screw
- Low Battery LED Indicator Light
- User friendly Variable Time Out Settings
- Serviceable Filtered Solenoid Valve
- Bak-Chek Tee for Hot/Cold Supply
- Vandal Resistant Spray Head with Pressure Compensating Flow Control
- Metal Jacketed Wire Protection for Sensor Lead
- Includes four (4) C-cell Alkaline Batteries
- Appropriate Mounting Hardware included

SLOAN



Part #	Description	Price
05460170	3305376 EBF 750-4 Optima GN Faucet	976.00



AUTOMATIC-FAUCETS-Automatic Faucets
RW List Prices - Page P-79

SF Series Sloan Hard-Wire Lav Faucet

- ADA Compliant, Sensor Activated, 6 VDC, Chrome Plated Brass, Hand Washing Faucet
- 0.5 gpm/1.9 Lpm Max Flow Spray Head
- Filtered Solenoid Valve with Strainer
- Splash-proof Circuit Control Module
- Adjustable Infrared Sensor Range
- 36" (914 mm) Long Sensor Cable
- 24" (610 mm) Long Flex Hose
- Bak-Chek® Tee for Hot/Cold
- 6 VDC Plug-in Transformer Aerator Spray Head
- Includes Batteries
- Includes Mounting Hardware



Part #	Description	Price
05450005	3362116 SF-2300 Sloan Sensor Faucet	490.00

SF Series Sloan Hard-Wire Lav Faucet

- ADA Compliant, Sensor Activated, 6 VDC, Chrome Plated Brass, Pedestal Hand Washing Faucet
- 0.5 gpm/1.9 Lpm Max Flow Spray Head
- Splash-proof Circuit Control Module
- Adjustable Infrared Sensor Range
- 36" (914 mm) Long Sensor Cable
- 24" (610 mm) Long Flex Hose
- Filtered Solenoid Valve with serviceable Strainer
- Bak-Chek® Tee for Hot/Cold Supply
- 6 VDC Plug-in Transformer
- Non-aerated Spray Head
- Includes Batteries
- Includes Mounting Hardware
- Trim Plate Kit for 4" Centerset Sink



Part #	Description	Price
05450000	3362103 SF-2100 Sloan Sensor Faucet	490.00

600 Sloan Optima® Hard-Wire Lav Faucet

- ADA Compliant, Sensor Activated, 24 VAC, Chrome Plated 4" Center-set Cast Brass, Faucet
- 0.5 gpm/1.9 Lpm Vandal Resistant Spray Head
- Splash-proof Circuit Control Module
- Sensor Range Adjustment Screw
- Troubleshooting LED Indicator Lights
- User Friendly Variable Time Out Settings
- Filtered Solenoid Valve with serviceable Strainer
- Bak-Chek Tee for Hot/Cold Supply
- 120 VAC/24 VAC Transformer (specify Plug-in or Box Mount)
- Vandal Resistant Spray Head with Pressure Compensating Flow Control
- Metal Jacketed Wire Protection for Sensor and Solenoid Leads
- Modular Quick-Release Sensor and Solenoid Connections



Part #	Description	Price
05460025	3365044 ETF-600-P Optima Lav Faucet	680.00

80 Sloan Optima® Hard-Wire Lav Faucet

- Sensor Operated Electronic Hand Washing Faucet for tempered or hot/cold water operation.
- 0.5 gpm/1.9 Lpm Vandal Resistant Spray Head
- Splash-proof Circuit Control Module
- Sensor Range Adjustment Screw
- Troubleshooting LED Indicator Lights
- User Friendly Variable Time Out Settings
- Filtered Solenoid Valve with serviceable "Y" Strainer
- Bak-Chek Tee for Hot/Cold Supply
- Trim Plate with Anti-Rotation Pin
- 120 VAC/24 VAC Plug-inTransformer-ETF-233
- Vandal Resistant Spray Head with Pressure Compensating Flow Control
- Metal Jacketed Wire Protection for Sensor and Solenoid Leads
- Modular Quick-Release Sensor and Solenoid Connections



Part #	Description	Price
05460101	3365320 ETF-85-4-P Optima Lav Faucet	758.00

AUTOMATIC-FAUCETS-Automatic Faucets
Page P-80 - RW List Prices

SF Series Sloan Hard-Wire Gooseneck Faucet

- ADA Compliant, Sensor Activated, 6 VDC, Chrome Plated Brass, Gooseneck Hand Washing Faucet
- 1.5 gpm/5.7 Lpm Laminar Spray Head
- Splash-proof Circuit Control Module
- Adjustable Infrared Sensor Range
- 36" (914 mm) Long Sensor Cable
- 24" (610 mm) Long Flex Hose
- Filtered Solenoid Valve with serviceable Strainer Filter
- Bak-Chek® Tee for Hot/Cold Supply
- 6 VDC Plug-in Transformer
- Includes Four (4) AA-size Batteries
- Includes appropriate Mounting Hardware
- Trim Plate Kit for 4" Centerset Sink



SLOAN



Part #	Description	Price
05450010	3362109 SF-2200 Sloan Sensor Faucet	474.00

275 Sloan Solis® Lav Faucet

- Solar Powered, Sensor Activated, Electronic, Chrome Plated Constructed Metal, Hand Washing Faucet
- 0.5 gpm/1.9 Lpm Aerator Spray Head
- Modular One-piece Construction with all Concealed Components above deck
- Double Infrared Sensors with Automatic Setting Feature
- Automatic Self-adapting Sensor Technology
- Solar Powered
- Magnetic Solenoid Valve
- Water Supply Connection with Flexible High-pressure Hose and Strainer
- Appropriate Mounting Hardware included
- Includes 6 VDC Lithium Battery Back-up Power Source



Part #	Description	Price
05450015	3335016 EAF-275 Sloan Sensor Faucet	844.00

700 Sloan Optima® Hard-Wire Gooseneck Faucet

- ADA Compliant, Sensor Activated, 24 VAC, Chrome Plated Brass, Gooseneck Hand Washing Faucet
- 2.2 gpm/8.3 Lpm VR Laminar Flow Spray Head
- Splash-proof Circuit Control Module
- Sensor Range Adjustment Screw
- Troubleshooting LED Indicator Lights
- User friendly Variable Time Out Settings
- Filtered Solenoid Valve with serviceable "Y" Strainer Filter
- Bak-Chek Tee for Hot/Cold Supply
- 120 VAC/24 VAC Plug-in Transformer (ETF-233)
- Vandal Resistant Spray Head with Pressure Compensating Flow Control
- Metal Jacketed Wire Protection for Sensor and Solenoid Leads
- Modular Quick-Release Sensor and Solenoid Connections



SLOAN



Part #	Description	Price
05460075	3365006 ETF-700-4-P Optima GN Faucet	870.00

Parts for Sloan Automatic Faucets

SLOAN

Part #	Description	Price
99510290	3315111 EBF-11-A Sloan Valve Module	256.10
99510292	0315104 EBF-60-A Sloan Optima Control Module Assy	320.18
99515040	3315254 EBF-1011-A Sloan Repair Kit	191.90
99510380	0315040 EBF-80-A Sloan Sensor Replacement Kit	120.98
99510160	0365534 ETF-233 Sloan Plug-In Transformer	39.38
99510280	0305849 ETF-370-A Sloan Solenoid Valve Assy	119.98
99510275	3365000 ETF-450-A Sloan Control Module Assy	185.90
99509285	3365461 ETF-617 3/8 Sloan Bak-Chek Tee®	35.50
99510285	3305577 ETF-1009-A Sloan Solenoid Valve Repair Kit	48.78



AUTOMATIC-FAUCETS-Automatic Faucets
RW List Prices - Page P-81

Toto EcoPower Single Supply Lav Faucet

- Self adjusting faucet with control box and mounting hardware, less supply lines.
- Chrome plated. 1/2" water supply male threaded.
- ADA compliant.
- 10 second continuous discharge, single supply.
- EcoPower hydropower self-generating system.
- Three Year Limited Warranty



Part #	Description	Price
14221010	TEL3GS10#CP Eco Sensor 10-sec Lav Faucet	720.00

Speakman Battery Lav Faucet

- Vandal-resistant, sensor activated faucet.
- Battery powered, uses 2 (two) 3 volt lithium batteries.
- low battery warning light when 10% life remains.
- ALL components housed above the counter.



Part #	Description	Price
14940110	S-9010 Speakman Battery Centerset Faucet	514.00

Toto EcoPower Thermal Mixing Lav Faucet

- Self adjusting faucet with control box and mounting hardware, less supply lines.
- Chrome plated.
- 1/2" water supply male threaded.
- ADA compliant.
- 10 second continuous discharge, thermal mixing.
- EcoPower hydropower self-generating system.
- Three Year Limited Warranty



Part #	Description	Price
14221000	TEL5GS10#CP Toto Eco Sensr 10-sec Lav Fct with Mix Vlv	989.90

Toto Cover Plates

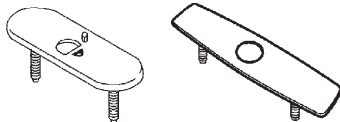

Part #	Description	Price
14221100	TN71V100S Toto 4in Cover Plate	96.78
14221110	71244T8CC Toto 8in Cover Plate	83.58



TSBRASS-T & S Brass
Page P-82 - RW List Prices

Gooseneck Pre-Rinse Deck Mount Unit

- Spring action type gooseneck.
- With B-0107 Spray Valve
- Includes mixing faucet.
- Deck type has under-sink mixing spreader with built-in spring checks, 1/4" IPS tailpiece connections on 4" centers.
- Approx. 40" high w/overhang of about 15" and w/9" clearance.
- In normal position, spray valve hangs approx. 31" below top of gooseneck spring.



Part #	Description	Price
24961203	B-0113 Pre-Rinse Unit	542.00

Pre-Rinse Spray Valve and Hose

- Designed for heavy duty use in commercial and industrial kitchens.
- Automatic shut off.
- B-0107 Head included
- 3' polished flex SS hose and 1/2" IPS male inlet.
- Overall length is 48".

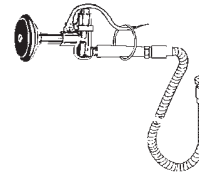

Part #	Description	Price
24961112	B-0100 Pre-Rinse Spray	220.90

Gooseneck Pre-Rinse Wall Mount Unit

- Spring action type gooseneck.
- With B-0107 Spray Valve
- Includes mixing faucet.
- Faucet has 8" Centers with 1/2 IPS female eccentric flanged union inlets
- Approx. 40" high w/overhang of about 15"
- 5" from bottom of spray valve to C/L of faucet

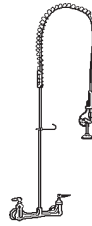

Part #	Description	Price
24961215	B-0133 Wall Mount Pre-Rinse Unit	576.00

Pre-Rinse Hose

- Built-in backflow preventer.

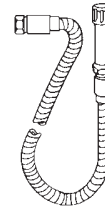

Part #	Description	Price
24961286	B-0044-H Stainless Flex Hose	111.38

Spring & Spring Riser



Part #	Description	Price
24961807	001R Spring	93.18



TSBRASS-T & S Brass
RW List Prices - Page P-83

Pre-Rinse Spray Valve

- Designed for heavy duty use in industrial kitchens.

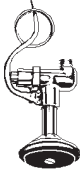

Part #	Description	Price
24961153	B-0107 Pre-Rinse Spray Head	125.90

Wall Bracket for Gooseneck Units

- Furnished with 6" nipple.



Part #	Description	Price
24961187	B-0109-01 Wall Bracket	74.10

Repair Kit for B-107 Spray Valve

Kit Contains:

- 2 - B-107 Packing Stem
- 2 - Valve Stem
- 1 - Sprayface Screw
- 1 - B-107 Sprayface
- 1 - Silicon Grease Tube
- 1 - Assembly Page
- 2 - B-107 Hose Washer
- 2 - B-107 Seat Washer
- 2 - B-107 Bonnet Washer
- 2 - Bonnet Binding Washer
- 1 - B107 Sprayhead Ring
- 2 - B-107 Squeeze Valve Springs

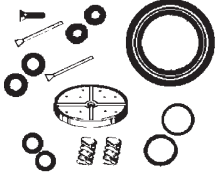

Part #	Description	Price
24961245	B10K Repair Kit	30.90

Index Buttons for Pre-Rinse Assemblies



Part #	Description	Price
49592220	001661-45 Hot	1.98
49592260	001660-45 Cold	1.98

Stems for Pre-Rinse Assemblies

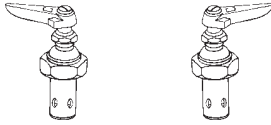

Part #	Description	Price
49592230	002712-40 Hot Eterna RH	76.18
49592240	002711-40 Cold Eterna LH	76.18

Misc Parts for B-0107



Part #	Description	Price
24900031	0004 Rubber Ring	5.98
24983901	001121-45 Spray Face for B-0107	9.30

Pre-Rinse Adapters



Part #	Description	Price
49592300	053A x Chicago Pre Rinse Adapter	18.78
49592310	172A x Fisher Pre Rinse Adapter	29.30

14" Swing Spout

- Length 14"
- Rise 4-1/4"



Part #	Description	Price
24900040	063X 14In Swing Spout	58.30



CHICAGO-Chicago Faucet
Page P-84 - RW List Prices

Prefix / Suffix Definitions and Finish Codes

Prefix/Suffix Definitions

BA faucet body outlet adapter
C integral check
CC center to center
CH cross handle
CO center outlet
CW cold water
D display kit
DB double bend spout
DJ double jointed swing spout
DK double pipe support
DS dual service with shank pasted (Loctite 565 pst) & assembled to fitting - valves shipped loose
DSVR dual service with shank pasted. valve & nozzle epoxied (2 part) all assembled complete to fitting
EP wall mount pedal box extended pedal
EX wall mount supply shank extension
F female inlet
FC flow control
GN gooseneck spout
H# height of spout GN2B#8
HA high arc spout
HR high rise spout
IS integral spout
JK repair part
K assembly of parts
L# swing spout (L6, L8)
LD less dish

LF less flange
LH left hand
LK loose key
LKC loose key check valve
LP cabinet mounted pedal box long pedal
LS long shank
M male type adapter
MM metal to metal unit
NS non-swing
OH oscillating handle
PVB anti-siphon pressure type vacuum breaker
RH right hand
RGD rigid only spout
S riser, hose, & spray assembly only
S# swing spout (S6)
SA faucet outlet adapter
SFA supply from above
SFB supply from below
SLO slow closing
ST steam unit
SW 8" swivel connections
SWC sweat connection
SWG swing spout only
TF triple force™
TW third water inlet (for use with a pedal box)
VB vacuum breaker
VBG g-elevated VB (778 VBG)
VBR adjustable stop arms & VB spout (305 VBG)
VH vinyl hose

VO valve only
VOA fume hood valve only, angled flange
VOC valve only complete
VOG fume hood valve only, gas
VOGA fume hood valve only, gas - angled flange
VOS fume hood valve only, steam
VOSA fume hood valve only, steam - angled flange
VP vandal proof
VPA vandal proof aerator
VPC vandal proof complete
VPH vandal proof handle
VPP vandal proof pin or cover plate
VR all components assembled complete with epoxy (2 part) & VPP, VPH & VPA & spout where applicable
WC with cover (hose reels)
WC 12" centers
WH wheel handle
WS with shank pasted & assembled to fitting - valves shipped loose
WSL with shank loose
WSV with shank & valve pasted & assembled complete to fitting
WV white vinyl hose
X cartridge
XK ceramic cartridge
XT quatum cartridge

Finish Codes

BNF barrel nickel finish
BAF brushed aluminum finish
CP chrome plate
CEF clear epoxy finish
CTF tin plate inside, chrome outside
NF no finish
NPF nickel plate finish
RCF rough chrome finish
RBF rough brass finish
SAM satin antimicrobial
SPF silver plate finish
TPF tin plate finish



**CHICAGO-Chicago Faucet
RW List Prices - Page P-85**

420-CP Single Lever Lav Faucet

- 4 1/4" Metal Lever Handle with Red and Blue Service Button
- Ceramic Disc Operating Cartridge with Temperature Limit Stop
- 4 5/8" C-C Integral Cast Brass Spout
- E37 - 1.5 GPM Pressure Compensating Laminar Flow Outlet
- 1/2" NPSM Supply Inlets
- Less Drain



Part #	Description	Price
54902950	420-CP S/L 4 Lav Faucet L/Drain	138.00

404A-317 Lavatory Faucet

- 317 4" Wrist Blade Handles
- 377XKLHJK/377XKRHJK Quatern Ceramic Cart
- 8" Centers with 5" Spout
- 1/2" NPSM Coupling Nuts
- Less Drain
- E12 Aerator

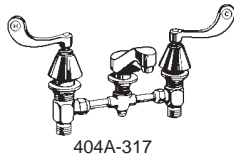

Part #	Description	Price
54902917	404V-317XK CP 8 Wrist Hdl Lav Fct	334.00

802A-317 Lavatory Faucet

- 317 4" Wrist Blade Handles
- 1-099XKJK/1-100XKJK Quatern Ceramic Cart
- 4" Centers with 4" Spout
- 1/2" NPSM Coupling Nuts
- Less Drain
- E12 Aerator

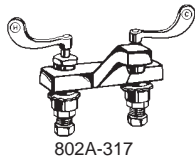

Part #	Description	Price
54907701	802V-317XK CP 4 Wrist Lav Faucet	196.00

895-317 Centerset Sink Faucet

- 317 4" Wrist Blade Handles
- 1-099XKJK/1-100XKJK Quatern Ceramic Cart
- GN1A 8 1/4" x 3 1/2" Rigid/Swing Spout (GNRGD1 is 8-15/16" x 3-7/8")
- (GNRG2 is 10-3/8" x 5-5/8")
- Field Convertible Gooseneck
- 1/2" NPSM Coupling Nuts
- Less Drain
- E3 Aerator
- Spout sold separately for 895-317LESSSPTXK

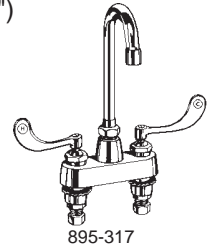

Part #	Description	Price
54908306	895-317XK CP 4 Gooseneck Faucet	228.00
54908327	895-317LESSSPTXK CP Less Spout Faucet	176.00

201A Widespread Sink Faucet

- 369 2 1/2" Lever Handles
- 8"cc with L-9 9 1/2" Swing Spout
- 377XKLHJK/377XKRHJK Quatern Cart
- 1/2" NPSM Coupling Nuts
- E3 Aerator
- Maximum Ware Thickness is 1 1/4"
- Spout sold separately

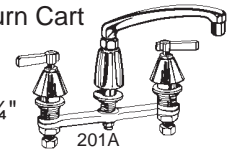

Part #	Description	Price
54901335	201ALESSSPTXK CP Less Spout Sink Faucet L/Spray	242.00

785 Widespread Sink Faucet

- 317 4" Wrist Blade Handles
- GN1A 8 1/4" x 3 1/2" Rigid/Swing Spout
- Field Convertible Gooseneck
- 377XKLHJK/377XKRHJK Quatern Cartridge
- 1/2" NPSM Coupling Nuts
- E3 Softflo Aerator
- Spout sold separately for 785LESSSPTXK

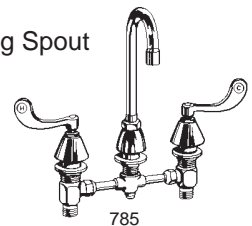

Part #	Description	Price
54907506	785XK CP 8 Gooseneck Lav Faucet	314.00
54907616	785LESSSPTXK CP Less Spout Lav Faucet	260.00



CHICAGO-Chicago Faucet
Page P-86 - RW List Prices

786 Widespread Sink Faucet

- 317 4" Wrist Blade Handles
- GN2A 9-3/4" x 5-3/8" Ridgid/Swing Spout
- Field Convertible Gooseneck
- 377XKLHJK/377XKRHJK Quatern Cartridge
- 1/2" NPSM Coupling Nuts
- E3 Aerator

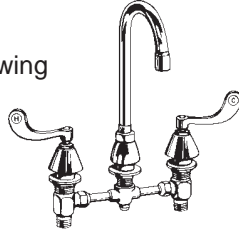

786-E3

Part #	Description	Price
54907600	786-E3XK CP 8 Gooseneck Lav Faucet	296.00

1100 Sink Faucet

- 1000 2-7/8" Wing Handle
- 8"cc with L-8 8" Swing Spout
- Spout sold separately
- 1-099XKJK/1-100XKJK Quatern Ceramic Cart
- 1/2" NPSM Coupling Nuts
- E3 Aerator

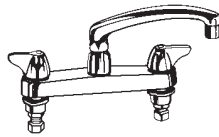

Part #	Description	Price
54909072	1100LESSPTXK CP Less Spout Sink Faucet	240.00

350 Single Hole Sink Faucet

- 369 2½" Lever Handle
- GN2A 9-3/4" x 5-3/8" Ridgid/Swing Spout
- Field Convertible Gooseneck
- 1-099XKJK Quatern Ceramic Cart
- 1/2" NPSM Coupling Nuts
- E3 Aerator

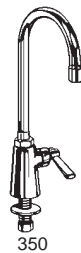

350

Part #	Description	Price
54902390	350XK CP Single Gooseneck Faucet	208.00

50 Single Hole Sink Faucet

- 369 2½" Lever Handle
- GN2A 9-3/4" x 5-3/8" Ridgid/Swing Spout
- Sold separately
- Field Convertible Gooseneck
- 1-099XKJK/1-100XKJK Quatern Ceramic Cart
- 3/8" OD Supply
- E3 Aerator

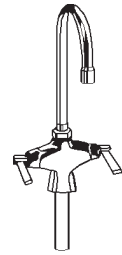

Part #	Description	Price
54900530	50LESSSPTXK CP Gooseneck Sink Fct	188.00

Visit us online
www.rwco.com



**CHICAGO-Chicago Faucet
RW List Prices - Page P-87**

305-R Service Sink Faucet

- 369 2½" Lever Handle
- 4" to 8-3/8" centers
- 1-099XKJK/1-100XKJK Quatern Ceramic Cart
- R Intregal Stop Adj Supply Arms
- 1/2" FIP Inlets
- 3/4" MHT Outlet

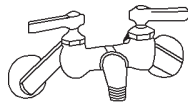

Part #	Description	Price
54901822	305-RXK RCF Service Sink Faucet	230.00

305-VB-R Service Sink Faucet

- 369 2½" Lever Handle
- 4" to 8-3/8" cc with 305SVB VB Spout
- 1-099XKJK/1-100XKJK Quatern Ceramic Cart
- R Intregal Stop Adj Supply Arms
- Vacuum breaker
- 1/2" FIP Inlets
- 3/4" MHT Outlet

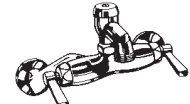

305-VB-R

Part #	Description	Price
54901830	305-VB-RXK RCF Service Sink Faucet	290.00

445 Service Sink Faucet

- 369 2½" Lever Handle
- 4" to 8-3/8" cc with S6 6" Spout
- Spout sold separately
- 1-099XKJK/1-100XKJK Quatern Ceramic Cart
- H Adj Supply Arms
- 1/2" FIP Inlets
- E3 Aerator



Part #	Description	Price
54903497	445LESSSPTXK CP Wall Faucet	222.00

897 Service Sink Faucet

- 369 2½" Lever Handle
- 7-5/8" to 8-3/8" cc with 897S VB Spout
- 1-099XKJK/1-100XKJK Quatern Ceramic Cart
- R Intregal Stop Adj Supply Arms
- Wall brace attaches to Spout
- Vacuum breaker
- 1/2" FIP Inlets
- 3/4" MHT Outlet

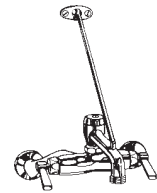

897

Part #	Description	Price
54908348	897CP Chrome Service Sink Faucet	192.00
54908356	897RCF Service Sink Faucet	146.00

540-LD Service Sink Faucet

- 369 2½" Lever Handle
- 7-1/4" to 8-3/4" cc with S6 6" Spout
- Spout sold separately
- 1-099XKJK/1-100XKJK Quatern Ceramic Cart
- G Adj Supply Arms with Union Cplg
- 1/2" FIP Inlets
- E3 Aerator

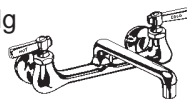

540-LD

Part #	Description	Price
54903601	540LDLESSSPTXK CP Wall Faucet	212.00

732-OH Urinal Rinse Down Valve

- Slow Self-Closing Angle Valve
- 386-010K Handle
- 386XSLO Cartridge
- 3/4" OD X 8" Outlet
- ½" FIP Inlet

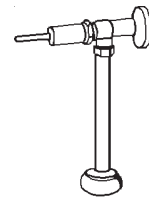

Part #	Description	Price
54905229	732-OH Flush Valve	190.00
54905187	732-OHVB Flush Valve	278.00



CHICAGO-Chicago Faucet
Page P-88 - RW List Prices

L9 Swing Spout

- Tubular with CP Finish
- 6½" Tall x 9½" Long
- 2 gpm at 80 psi
- E3 Aerator



Part #	Description	Price
54912068	L9JK 9 Swing Spout	86.00

L12 Swing Spout

- Tubular with CP Finish
- 4-5/8" Tall x 12" Long
- 2 gpm at 80 psi
- E3 Aerator



Part #	Description	Price
54912084	L12JK 12 Swing Spout	86.00

L15 Swing Spout

- Tubular with CP Finish
- 4-5/8" Tall x 14" Long
- 2 gpm at 80 psi
- E3 Aerator

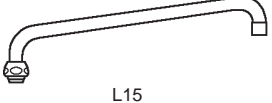

Part #	Description	Price
54912092	L15JK 15 Swing Spout	120.00

HA8JKCP High Rise Swing Spout

- Tubular with polished chrome Finish
- 9-3/8" Tall x 7-3/4" Long (8" Inlet to Outlet Projection)
- 2 gpm at 80 psi
- E12 Aerator
- Fits 1 1/16" - 18 UNEF Male Thread Body Outlet



Part #	Description	Price
54912300	HA8JKCP High Rise Swing Spout	146.00

S6 Swing Spout

- Cast Brass with CP Finish
- 6" Tall, 2 gpm at 80 psi
- E3 Aerator



Part #	Description	Price
54912027	S6JK Swing Spout	90.00

L8 Swing Spout

- Cast Brass with CP Finish
- 4-3/4" Tall x 8" Long
- 2 gpm at 80 psi
- E3 Aerator

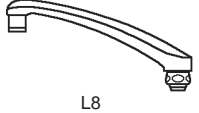

Part #	Description	Price
54912043	L8JK 8 Swing Spout	112.00

DJ13 Swing Spout

- Cast Brass with CP Finish
- 7" to 13" Long
- 2 gpm at 80 psi
- E3 Aerator

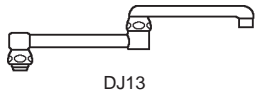

Part #	Description	Price
54912100	DJ13JK 13 Double Jointed Spout	168.00

DJ18 Swing Spout

- Cast Brass with CP Finish
- 11-3/4" to 17-3/4" Long
- 2 gpm at 80 psi
- E3 Aerator

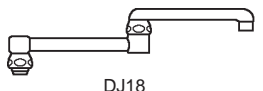

Part #	Description	Price
54912142	DJ18JK 18 Double Jointed Spout	180.00



**CHICAGO-Chicago Faucet
RW List Prices - Page P-89**

L5VBJKCP Vacuum Breaker Spout

- 5-3/4In C-C Cast Brass Atmospheric Vacuum Breaker Swing Spout with 3/4In Male Hose Thread Outlet
- 4In Height to Top of Spout
- 1In Height to Outlet
- 5-3/4In Inlet to Outlet Projection
- Atmospheric Vacuum Breaker, Not Intended For Continuous Pressure Applications
- Fits 1 1/16In - 18 UNEF Male
- Thread Body Outlet
- Polished Chrome Finish

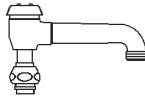

Part #	Description	Price
54912076	L5VBJKCP Vacuum Breaker Spout	186.00

L8BVBJKCP Vacuum Breaker Spout

- 8In C-C Atmospheric Vacuum Breaker Swing Spout with 3/8In - 18 NPSM Female Outlet
- 4In Height to Top of Spout
- 1/4In Height to Outlet
- 8In Inlet to Outlet Projection
- Atmospheric Vacuum Breaker, Not Intended For Continuous Pressure Applications
- Fits 1-1/16In - 18 UNEF Mal Thread Body Outlet
- Polished Chrome Finish

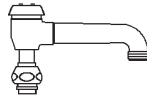

Part #	Description	Price
54912167	L8BVBJKCP Vacuum Breaker Spout	202.00

DJ13BVB Double Jnt Vacuum Breaker Spout

- Cast Brass with CP Finish
- 7" to 13" Long
- 3/8" NPSM FIP outlet for "B" ends

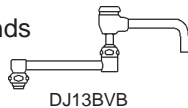

Part #	Description	Price
54912118	DJ13BVBJK Vacuum Breaker Spout	324.00

DJ18BVB Double Jnt Vacuum Breaker Spout

- Cast Brass with CP Finish
- 11-3/4" to 17-3/4" Long
- 3/8" NPSM FIP outlet for "B" ends

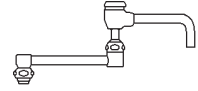

Part #	Description	Price
54912159	DJ18BVBJK Vacuum Breaker Spout	344.00

GN Group A Gooseneck Spouts

- GN1A-JK-E3 8-1/4" Tall x 3-1/2" Long
- GN2A-JK-E3 9-3/4" Tall x 5-3/8" Long
- GN8A-JK-E3 11-1/4" Tall x 8" Long
- GN2AH8-JK-E3 8" Tall x 5-3/8" Long
- GN2AH13-JK-E3 13" Tall x 5-3/8" Long
- GN2AH17-JK-E3 17" Tall x 5-3/8" Long

- Rigid/Swing Field Convertible
- Group A 13/16" - 24 male end

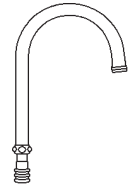

Part #	Description	Price
54912183	GN1AJKCP Gooseneck Spout	74.00
54912191	GN2AE3JKCP Gooseneck Spout	86.00
54912290	GN8AJKCP Gooseneck Spout	108.00
54912175	GN2AH8JKE3 Gooseneck Spout	110.00
54912225	GN2AH13JKE3 Gooseneck Spout	134.00
54912266	GN2AH17JKE3 Gooseneck Spout	142.00

GN Group B Gooseneck Spouts

- GN2BH8-JK 8" Tall x 5-3/8" Long
- GN8BJKCP 11-1/4" Tall x 8" Long

- Rigid/Swing Field Convertible
- Group B 3/8" FIP end

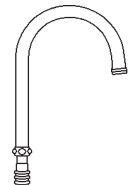



Part #	Description	Price
54912270	GN2BH8JK Gooseneck Spout	100.00
54983159	GN8BJKCP Gooseneck Spout	128.00



CHICAGOP-Chicago Parts
Page P-90 - RW List Prices

Quaturn Exposed Cap Stems		
		
Part #	Description	Price
79511310	1-099XTD RH Quaturn Stem	33.70
79511315	1-100XTD LH Quaturn Stem	33.70

Quaturn Concealed Cap Stems		
		
Part #	Description	Price
79511830	377XTRHD RH Concealed Stem	39.50
79511825	377XTLHD LH Concealed Stem	39.50

Quaturn Ceramic Exposed Cap Stems		
		
Part #	Description	Price
79511320	1-099XKJK RH Quaturn Ceramic Stem	36.30
79511325	1-100XKJK LH Quaturn Ceramic Stem	36.30

Quaturn Ceramic Concealed Cap Stems		
		
Part #	Description	Price
79511820	377XKRHJK RH Ceramic Concealed Stem	47.10
79511812	377XKLHJK LH Ceramic Concealed Stem	47.10

In 1913, A.C. Brown invented a cartridge that laid the cornerstone of The Chicago Faucet Company. This major breakthrough in faucet design was the patented Quaturn cartridge. The replaceable, completely self-contained cartridge was revolutionary in its ability to turn water flow off from full flow with one-quarter turn of the handle. Also unique was the way the cartridge closed with the flow of the water rather than against it, reducing washer wear and virtually eliminating drips. It was noteworthy that the cartridge was replaceable and interchangeable with other Chicago Faucets products. The Quaturn cartridge became the standard of reliability, durability, and value as a result of Chicago Faucets commitment to standardization and renewability of parts. The Quaturn cartridge has been updated over the years to incorporate new technology and materials, but is still interchangeable with any Quaturn manufactured since 1913.

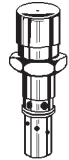
Naiad Push-Button Cartridges		
		
Part #	Description	Price
79511689	333XJK Naiad Push Button Cartridge	97.10



**CHICAGOP-Chicago Parts
RW List Prices - Page P-91**

Quaturn Jiffy Kit

- 4 Seat Washers - 1-021
- 2 Brass Washers - 93-031
- 2 Conical Packings - 93-131K
- 2 O-Rings - 1-2199
- 2 O-Rings - 1-328
- 2 Cap Thread Gaskets - 2-043
- 2 Gaskets - 1-043
- 1 Packing - 1-119K

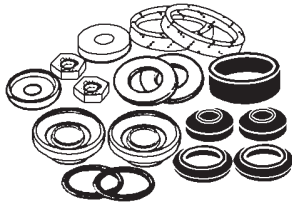

Part #	Description	Price
79511565	1277-D Quaturn Jiffy Repair Kit	24.18

Naiad Jiffy Kit

- 2 Springs - 395-018
- 2 Cup Washers - 333-040
- 4 O-Rings - 319-140
- 2 Leather Packings - 319-035
- 2 Soft Seat Washers - 244-006
- 2 Monel Seats - 1-027
- 2 Cap Thread Gaskets - 1-043

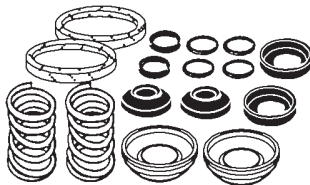

Part #	Description	Price
79512265	849-D Naiad Jiffy Repair Kit	28.30

Klo-Self Jiffy Kit

- 4 O-Rings - 319-140
- 2 Leather Packings - 319-035
- 2 Springs - 823-010
- 2 Soft Seat Washers - 244-006
- 2 Monel Seats - 1-027
- 2 O-Rings - 823-015

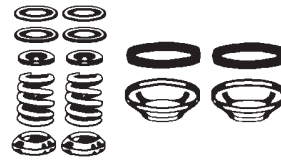

Part #	Description	Price
79512260	847-D Klo-Self Jiffy Repair Kit	28.30

Vacuum Breaker Jiffy Repair Kit

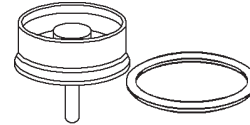

Part #	Description	Price
79511545	892-302JKNF Vacuum Breaker Jiffy Repair Kit	30.10
79511550	892-402KD Vacuum Breaker Kit With Cover	40.78

317 Handle

- 4" Metal Wrist Blade Style
- ADA Compliant



Part #	Description	Price
79511606	317PRJK CP 4 Blade Handle	96.30

319 Handle

- 6" Forged Brass Elbow Style
- ADA Compliant



Part #	Description	Price
79511663	319PRJK CP 6 Blade Handle	114.30



BKFCT-B&K Faucets & Valves
Page P-92 - RW List Prices

Lavatory 2H 4 Centerset Faucet

- Heavy, chrome-plated finish.
- Replaceable Quarter-turn washerless cartridge.
- Water saving aerator.

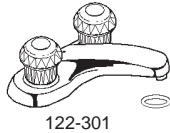

122-301

Part #	Description	Price
03320365	222-301H Acrylic 2H Lav Faucet With PU	60.00

Laundry Faucet

- Brass waterways
- Chrome plated
- 4" center distance
- Replaceable seats and stems.
- Tubular spout with 2.0 GPM aerator.
- Hose thread adapter for spout included

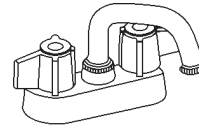

125-503

Part #	Description	Price
03320605	225-503 Laundry Faucet	60.00

Lavatory 1H 4 Centerset Faucet

- Heavy, chrome-plated finish.
- Water saving aerator.

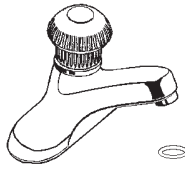

122-327

Part #	Description	Price
03320940	222-327 Knob S/L Lav Faucet With PU	66.00

Bar 2H Faucet

- 4" Center Set
- Acrylic handles
- Replaceable Quarter Turn washerless cartridge

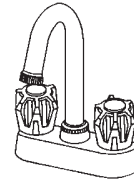

122-601

Part #	Description	Price
03320510	222-430 Acrylic 2H Bar Faucet	56.00

Ledgeback Lavatory Faucet

- Brass body construction
- Chrome plated finish
- Adjustable (4½"-6") center distance

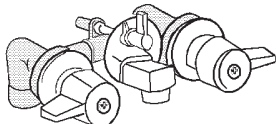

121-998

Part #	Description	Price
03320075	221-998 Ledgeback Lav Faucet	156.00

Basin Faucet

- Heavy duty chrome plated brass.
- Replaceable seats and stems.
- Energy efficient 2.5 GPM water saving aerator.
- Includes both hot and cold index buttons.



120-005

Part #	Description	Price
03320050	220-005 Single Hole Lavatory Faucet	34.00



BKFACT-B&K Faucets & Valves
RW List Prices - Page P-93

Kitchen 2H Faucet W/Spray

- 8" Centerset
- Heavy, chrome-plated finish.
- Large acrylic handles.
- Water saving aerator.
- 9" Spout
- Replaceable dripless cartridge.

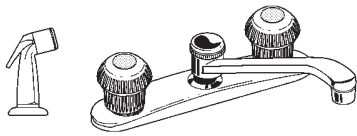

122-401

Part #	Description	Price
03320490	222-401H Acrylic 2H Sink Faucet With Spray	66.00

Kitchen 1H Faucet

- 8" Centerset
- Heavy, chrome-plated finish.
- Metal Lever Handle
- Water saving aerator.
- 9" Spout
- Replaceable Quarter-turn washerless cartridge.

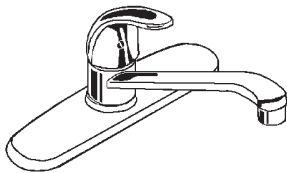

122-417

Part #	Description	Price
03320883	222-417 S/L Sink Faucet Less Spray	60.00

Kitchen 1H Faucet W/Spray

- 8" Centerset
- Heavy, chrome-plated finish.
- Metal Lever Handle
- Water saving aerator.
- 9" Spout
- Replaceable Quarter-turn washerless cartridge.

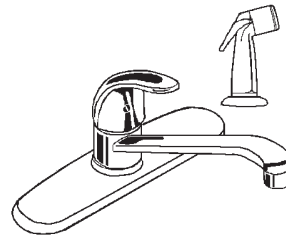

122-418

Part #	Description	Price
03320865	222-418 S/L Sink Faucet With Spray	72.00

Wallmount Faucets

- Polished chrome.
- 1/2" Female threaded couplings.
- Adjustable flange.
- Replaceable seats and stems.

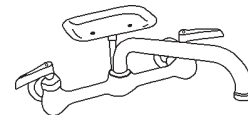

123-009/123-012

Part #	Description	Price
03320575	123-009 Service Sink Faucet With 8 Spout	96.00
03320600	223-012 Service Sink Faucet With 14 Spout	106.00



BKFCT-B&K Faucets & Valves
Page P-94 - RW List Prices

Shower Stall Faucets

- Chrome-plated trim.
- 3-3/8" Center distance.
- Cast-brass body with plug.
- Acrylic handles.
- Bottom or top supply.
- Replaceable seats and stems.

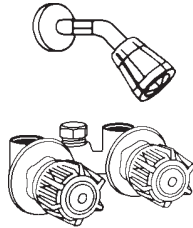

Part #	Description	Price
03320000	126-003 Acrylic 2H Shower Valve	48.00

Utility Shower Faucets

- Chrome-plated, cast brass body.
- Union inlets are combination threaded or sweat connection.
- Package includes galvanized riser, shower head, and soap dish.

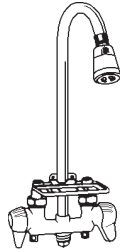

Part #	Description	Price
03320025	126-005 Utility Shower Faucet	80.00

Leg Tub Faucet

- Gooseneck Spout
- Polished chrome finish.
- Replaceable seats and stems.
- 1/2 IPS inlets



Part #	Description	Price
03321155	123-005 Leg Tub Faucet w Gooseneck Spout	50.00

2H Tub & Shower Diverter Valves

- Heavy, chrome-plated trim.
- Cast brass body.
- 1/2" Unions for threaded or solder installation.
- Acrylic handles.
- Quarter turn washerless cartridge.

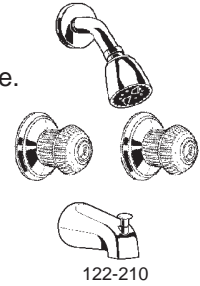

Part #	Description	Price
03321065	222-210 Acrylic 2H T&S Valve	92.00



HANDSHOW-Hand Held Showers
RW List Prices - Page P-95

2-Spray Hand Shower

- Full Spray
- Pause Control

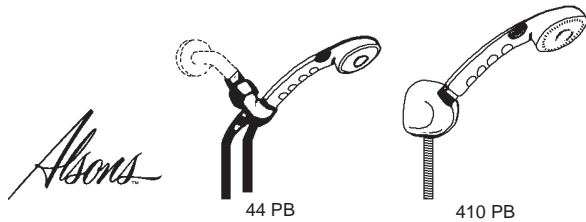

Part #	Description	Price
14950010	410 PB PK Wht Wall Mount HH Shower	66.00
14950000	44 PB PK Wht Shower Arm Mount HH Shower	68.00

4435 5-Spray/Massage Hand Shower

- Wall Mounted
- Fast Massage
- Slow Massage
- Full Spray with Massage
- Full Spray
- Pause Control

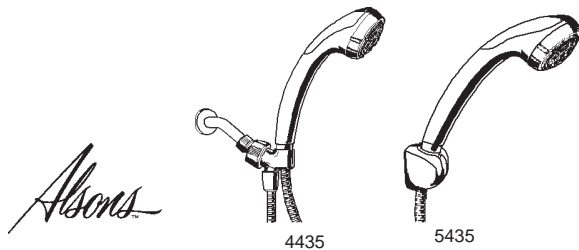

Part #	Description	Price
14950275	4435 PK Wht Shower Arm Mount HH Shower	70.00
14950265	4435 C PK CP Shower Arm Mount HH Shower	80.00
Part #	Description	Price
14950277	5435 PK Wht Wall Mount HH Shower	76.00
14950278	5435C PK CP Wall Mount HH Shower	86.00

Euro Style 5-Spray/Massage Hand Shower

- Wall Mounted
- Fast Massage
- Slow Massage
- Full Spray with Massage
- Full Spray
- Pause Control

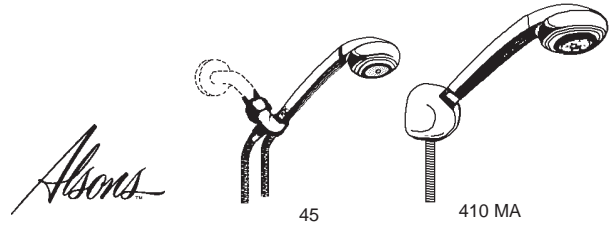

Part #	Description	Price
14950264	45 C PK CP Shower Arm Mount HH Shower	118.00
14950263	45 2010 PK PB Shower Arm Mount HH Shower	216.00
Part #	Description	Price
14950030	410MAC PK CP Wall Mount HH Shower	128.00
14990040	410MA 2010PK PB Wall Mount HH Shower	216.00

ADA Wall Grab Bar/Hand Shower System

- 2-Spray Head
- 24" SS Wall Grab Bar
- 69" Metal Hose
- Mounts Horizontal or Vertical





Part #	Description	Price
14990044	62001 DS Bx ADA Grab Bar Shower System	176.00

HANDSHOW-Hand Held Showers
Page P-96 - RW List Prices
Replacement Hand Showers Parts - Alsons

462 2-Spray Repl Head

- Full Spray
- Pause Control

Part #	Description	Price
14950035	462 PB PK Wht HH Shower Repl Head	34.00

435 5-Spray/Msg Repl Head

- Fast Massage
- Slow Massage
- Full Spray with Massage
- Full Spray
- Pause Control



Part #	Description	Price
14990025	435 PK Wht HH Shower Repl Head	50.00
14990023	435 PK CP HH Shower Repl Head	58.00

425 Euro Style 5-Spray/Msg Repl Head



- Fast Massage
- Slow Massage
- Full Spray with Massage
- Full Spray
- Pause Control



Part #	Description	Price
14990020	425 C PK CP HH Shower Repl Head	98.00
14990000	425 2010 PK PB HH Shower Repl Head	142.00

Ultraflex® White Shower Hose

- White Hose w/Chrome or Polished Brass Ribbon
- 1 Conical & 1 Hex All-Brass Nuts

Part #	Description	Price
14950170	494 C 70PK Wht & CP 70 UltraFlex Hose	40.00

Ultraflex® Black Shower Hose

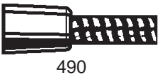

- Black Hose w/Chrome or Polished Brass Ribbon
- 1 Conical & 1 Hex All-Brass Nuts

Part #	Description	Price
14950070	490 70 PK Blk & CP 70 Ultraflex Hose	40.00
14950072	490 2070 PK Blk & PB 70 Ultraflex Hose	62.00

Metal Shower Hose

- Brass Double Spiral & Stainless Steel Hose
- 1 Conical & 1 Hex All-Brass Nuts

Part #	Description	Price
14950176	495 DS 69 PK CP 69 Metal Hose	48.00
14950178	495 DS 2069 PK PB 69 Metal Hose	122.00

Shaded Items are Non-Stock



Reeves-Wiedeman Company
PLUMBING SUPPLIES FOR CONTRACTORS AND INDUSTRY

HANDSHOW-Hand Held Showers
RW List Prices - Page P-97

Wall Bars

- 24" Glide Rail

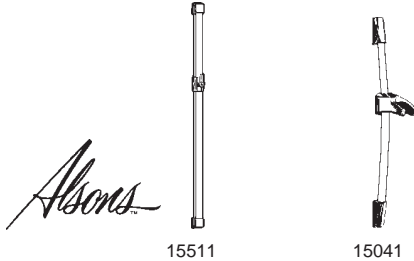

Part #	Description	Price
14950100	15511 C PK CP 24 Pin Mnt Wall Bar	102.00
14950097	15041 C Bx CP 24 Hose Mnt Wall Bar	128.00

Wall Mounts



Part #	Description	Price
14950110	5001 PK CP Clear Pin Wall Mount	18.90
14950112	5001 2010 PK PB Clear Pin Wall Mount	32.50
Part #	Description	Price
14950124	3001 PK Wht Hose Wall Mount	21.70
14950122	3001 C PK CP Hose Wall Mount	24.30
14950120	3001 2010 PK PB Hose Wall Mount	51.10

Shower Arm Mounts

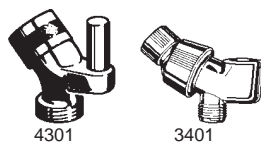

Part #	Description	Price
14950245	4301 PK CP Metal Pin Shower Arm Mount	28.38
Part #	Description	Price
14950139	3401 PK Wht Hose Nut Shower Arm Mount	16.30
14950137	3401 C PK CP Hose Nut Shower Arm Mount	18.90
14950135	3401 2010 PK PB Hose Nut Shower Arm Mount	42.38

Swivel Connectors



Part #	Description	Price
14950260	5002 PK CP Mtl Pin Mnt Swivel Connector	32.50

Vacuum Breaker

- Atmospheric type
- 1/2" connections with brass shield



Part #	Description	Price
14950190	4900 PK CP Vacuum Breaker	33.70

Water Supply Elbow

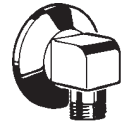

Part #	Description	Price
14950192	4990 F PK CP 1/2 Wtr Supply Elbow	46.18

Volume Control



Part #	Description	Price
14950045	476 PK CP Volume Control w Pause	32.50
14950044	476 2010 PK PB Volume Control w Pause	58.58

Reeves-Wiedeman Company



Emporia, Ks	Grandview, Mo	Independence, Mo	KCMO-Downtown	KCMO-Midtown	KCMO-Waldo	Lawrence, Ks	Junction City, Ks	Leavenworth, Ks
Liberty, Mo	Lees Summit, Mo	Lenexa, Ks	Manhattan, Ks	Maryville, Mo	Olathe, Ks	Riverside, Mo	Saint Joseph, Mo	Topeka, Ks

Shaded Items are Non-Stock

HANDSHOW-Hand Held Showers
Page P-98 - RW List Prices

Water Diverter

- Deluxe Push Pull Control





4923

Part #	Description	Price
14950060	4923 PK CP Push-Pull Water Diverter	60.00
14950210	4923 2010 PK PB Push-Pull Water Diverter	80.00

Diverter Spout Add-A-Shower

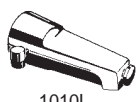
- Extra long diverter tub spout
- 1/2" and 3/4" connections

1010L

Part #	Description	Price
14950040	1010 L PK CP Diverter Tub Spout	80.00
14950038	1010 L 2010 PK PB Diverter Tub Spout	128.00

Since the introduction of its hand-held shower systems in 1958, Alsons has been revolutionizing the way America bathes. Today the company offers hundreds of distinct choices. Designers, builders and remodelers may select from hand-held showers and shower heads in a wide variety of styles, functions, and finishes to personalize any bath.

The company's shower products are available in complete units for easy installation. Alsons also offer individually packaged components for custom configurations - including all the styles, colors, mounting options, and accessories necessary to fulfill any shower need.



Reeves-Wiedeman Company

PLUMBING SUPPLIES FOR CONTRACTORS AND INDUSTRY

**HANDSHOW-Hand Held Showers
RW List Prices - Page P-99**

Croma E 75 3-Jet SAM Set

- ShowerArm Mount
- 63" techniflex hose
- Croma 3-Jet handshower with full, massage and mono sprays
- Replaces showerhead



Part #	Description	Price
74901040	Croma E75 Handshower Set	132.00

Croma E 75 Green Handshower Head

- Features Quiclean cleaning system
- Drenching full spray
- 50 no-clog spray channels
- 1.6 GPM flow (feels like 2.5 GPM)
- EcoAIR technology



Part #	Description	Price
74901035	Croma E75 Green HH Shower Repl Head	56.00

Croma E100 Green Handshower Head

- Green 3-Jet Handshower
- Oversized 4" spray face
- Features Quiclean function
- Full spray, massage and intense massage
- EcoAIR technology
- AIR-injection technology
- 75 no-clog spray channels
- Flow 1.75 GPM, 30% savings



Part #	Description	Price
74901025	Croma E100 Green HH Shower Repl Head	90.00

EcoAIR: Up to 36% Water Savings

Hansgrohe's Croma Green handshowers and showerheads provide the full, drenching coverage of a conventional high-end product, but at a water-saving flow rate of only 1.6 – 1.75 GPM. These environmentally friendly showers feature Hansgrohe's award-winning and innovative EcoAIR technology for enhanced "low flow" performance. Plus, we offer a variety of styles (E for transitional style, C for traditional design), several finish options, as well as models with invigorating multiple spray modes. Best of all, these products are available at a price that meets any budget, even with the high-end technology and characteristic Hansgrohe quality.

Croma C 75 2-Jet Handshower Head

- Traditional design
- 2 spray modes: full and massage spray
- Features Quiclean cleaning system
- 40 no-clog spray channels



Part #	Description	Price
74901030	Croma C75 HH Shower Repl Head	76.00

Reeves-Wiedeman Company

Emporia, Ks	Grandview, Mo	Independence, Mo	KCMO-Downtown	KCMO-Midtown	KCMO-Waldo	Lawrence, Ks	Junction City, Ks	Leavenworth, Ks
Liberty, Mo	Lees Summit, Mo	Lenexa, Ks	Manhattan, Ks	Maryville, Mo	Olathe, Ks	Riverside, Mo	Saint Joseph, Mo	Topeka, Ks

Shaded Items are Non-Stock

HANDSHOW-Hand Held Showers
Page P-100 - RW List Prices

Croma C100 Green Handshower Head

- Green 3-Jet Handshower
- Oversized 4" spray face
- Features Quiclean function
- Full spray, massage and intense massage
- EcoAIR technology
- AIR-injection technology
- 75 no-clog spray channels
- Flow 1.75 GPM, 30% savings



hansgrohe

Part #	Description	Price
74901020	Croma C100 Green HH Shower Repl Head	98.00



HANDSHOW-Hand Held Showers
RW List Prices - Page P-101

Unica E 26" Wall Bar

- Handshower holder moves up and down, pivots left and right
- Knob with finger grip for easy slide adjustment
- Angle adjustable acrylic holder
- Includes soap dish

hansgrohe



Part #	Description	Price
74901045	26" Unica E wall bar	108.00

Porter'E Handshower Holder

- Wall Mounted, 1 position handshower holder
- Fits all hoses with a conical nut

hansgrohe



Part #	Description	Price
74901055	Porter'E Handshower Holder	36.10

Wall Outlet

- 1/2" NPT female inlet
- Fits all 1/2" hoses

hansgrohe



Part #	Description	Price
74901060	Wall Outlet	52.70

Wall Outlet with Vacuum Breaker

- 1/2" NPT female inlet
- Internal vacuum breaker
- Fits all 1/2" hoses

hansgrohe



Part #	Description	Price
74901065	Wall Outlet w/Vacuum Breaker	78.50

Inversa Diverter for Showerarm

- Solid brass
- Diverts between showerarm and showerhead
- Use with 1/2" hose and handshower

hansgrohe



Part #	Description	Price
74901070	Inversa Diverter for Showerarm	63.10

Showerarm Mount for Handshower

- Holder mounts on end of 1/2" showerarm and easily replaces showerhead with handshower
- Angle adjustable
- Flow restrictor 2.5 GPM
- Internal check valve back flow prevention

hansgrohe



Part #	Description	Price
74901075	Showerarm Mount for Handshower	33.30

Chrome 63" Techniflex Hose

- With brass swivel connector to prevent hose twisting
- Revolutionary solid color finish

hansgrohe



Part #	Description	Price
74901080	Chrome 63in Techniflex Hose	48.50



EYEWASH-Eyewash
Page P-102 - RW List Prices

Model 7620 AXION™ eyePOD™

- Simple to install on standard faucets
- Easy rotation for on/off operation
- Inverted water flow pattern for superior eye protection
- Safety shut-off valve to prevent scalding at high temperatures



Part #	Description	Price
25000010	7620 Haws Axion EyePod Eye Wash	238.00