

Widespread Lavatory Faucets 6"-12" Centers

TECK[®]
COMMERCIAL

DELTA[®]

Specification: (example)

- Two handle widespread lavatory faucet
 - 152 to 305mm (6" to 12") adjustable centers
 - Polished chrome plated finish trim
 - **CAST BRASS** bodies
 - 4 1/2" **CAST BRASS** spout or 3/8" IPS **BRASS PIPE** Rigid/Swivel Gooseneck Spout
 - Metal hold-down package
 - Color indexed metal handles with vandal resistant screws
 - **CER-TECK[®]** 1/4 turn ceramic structures
- and ... with ... (add product variation required)
 with ... (add outlet required)
 with ... (add handle required)
 with ... (add suffix **-LS** if required – See Back Page)
 with ... (add suffix **-TI** if required – See Back Page)



Engineer/Architect Approval



















Model Specified:

Approval:

Date:

DESCRIPTION	PRODUCT NO.
Widespread Lavatory Faucet	23C



PRODUCT VARIATION	OUTLET	HANDLE
0 <input type="checkbox"/>	0 <input type="checkbox"/>	0 <input type="checkbox"/>
1 <input type="checkbox"/>	1 <input type="checkbox"/>	1 <input type="checkbox"/>
2 <input type="checkbox"/>	2 Vandal Resistant 1.5 gpm (5.7 L/min.) Laminar w/Agion [®] Antimicrobial  <input type="checkbox"/>	2 102mm (4") Hooded Blade Handles (4)  <input type="checkbox"/> 
3 Cast Spout Less Pop-up (No Pop-up Hole)  <input type="checkbox"/>	3 Vandal Resistant 1.5 gpm (5.7 L/min.) Flow Control Aerator  <input type="checkbox"/> 	3 76mm (3") Hooded Lever Handles (4)  <input type="checkbox"/> 
4 Cast Spout With Metal Pop-up (With Pop-up Hole)  <input type="checkbox"/>	4 Standard 1.5 gpm (5.7 L/min.) Flow Control Aerator  <input type="checkbox"/> 	4 102mm (4") Blade Handles, Sanitary Hoods (4)  <input type="checkbox"/> 
5 <input type="checkbox"/>	5 Vandal Resistant 0.5 gpm (1.9 L/min.) Flow Control Non-Aerating Spray Outlet  <input type="checkbox"/>	5 152mm (6") Wrist Handles, Sanitary Hoods  <input type="checkbox"/> 
6 Heavy Duty Rigid/Swivel Inline (R2) Gooseneck Spout Less Pop-up (1) (3)  <input type="checkbox"/>	6 <input type="checkbox"/>	6 <input type="checkbox"/>
7 <input type="checkbox"/>	7 Smooth End, Laminar Flow Control in Base of Gooseneck Spout 1.0 gpm (3.8 L/min.) (2)  <input type="checkbox"/> 	7 <input type="checkbox"/>
8 <input type="checkbox"/>	8 <input type="checkbox"/>	8 <input type="checkbox"/>
9 <input type="checkbox"/>	9 <input type="checkbox"/>	9 <input type="checkbox"/>

(1) Available **Optional Rigid/Swivel Spouts**. These spouts can ONLY be added to **BASIC PRODUCT Option No. 6**. (2) This outlet can ONLY be added to **BASIC PRODUCT Option No. 6**. (3) 120° Limited Swing Spout available. Add Suffix **-LS**. (4) H & C Temperature Indicator available. Add suffix **-TI**. Refer to www.specselect.com for individual models. Flow Rates are at 60 PSI. Note: Use this page front and back as a product submittal sheet.

Delta reserves the right (1) to make changes in specifications and materials, and (2) to change or discontinue models, both without notice or obligation. Dimensions are for reference only. See current full-line price book or www.specselect.com for finish options and product availability.



TECK[®]
COMMERCIAL

Widespread Lavatory Faucets 6"-12" Centers

Approvals:

- CSA certified
 - Complies to ASME A112.18.1/CSA B125.1
 - Handles No. 2, 3, 4, and 5
Indicates compliance to ICC/ANSI A117.1
 - Outlet options 2, 3, 4 and 7 are EPA WaterSense listed
 - Verified compliant with 0.25% weighted average Pb content regulations
- (Contact Delta Representative for State and/or Local Approvals.)

HANDLE TEMPERATURE INDICATORS

- Add suffix **"-TI"** to Product Number for handle temperature indicators "H" (red), "C" (blue).
- Available on handle options 2, 3 or 4 only.

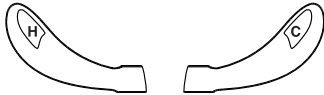

FLOW RATE vs PRESSURE

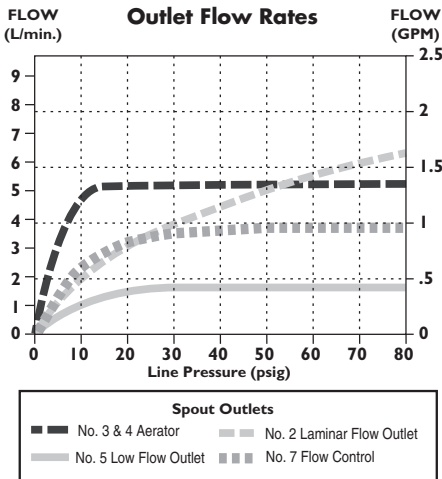

OUTLET NO.	GOOSENECK SPOUT "D"		CAST SPOUT "D"	
	mm	in.	mm	in.
2	18	0.69	11	0.45
3	18	0.69	11	0.45
4	17	0.67	11	0.45
5	18	0.69	11	0.45

LIMITED SWING GOOSENECK

- Add suffix **"-LS"** to Product Number for 120° Limited Swing – Available on #6 Product Variation ONLY

FRONT VIEWS

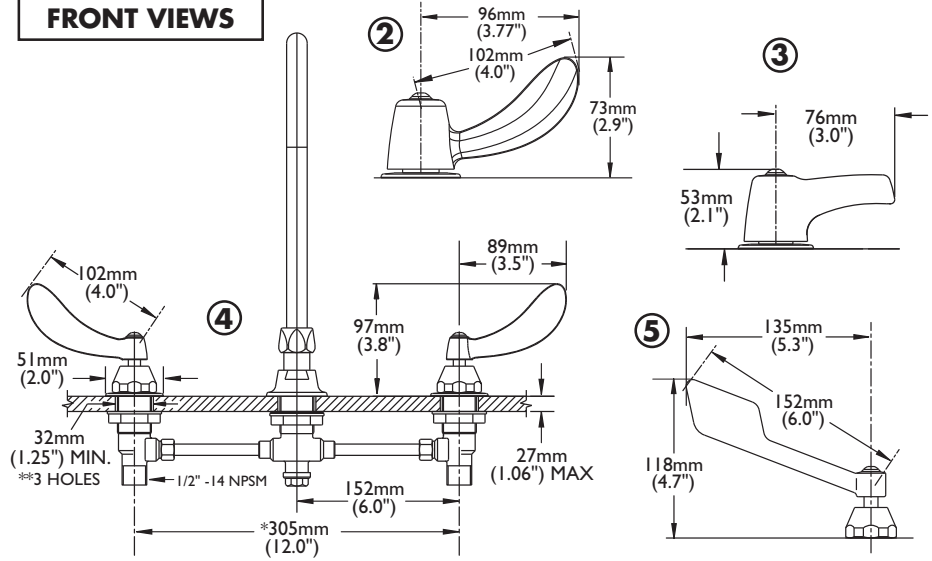

* CAN BE CUT IN FIELD TO 152mm (6.0") MINIMUM INLET FOR 3/8" OR 1/2" FLEXIBLE RISER OR 1/2-14 NPSM COUPLING NUT (NOT SUPPLIED)

GOOSENECK SPOUT #6

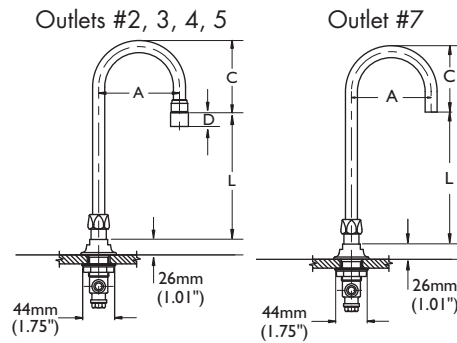

**Spout hole 38mm (1.5") maximum diameter.

CAST SPOUT

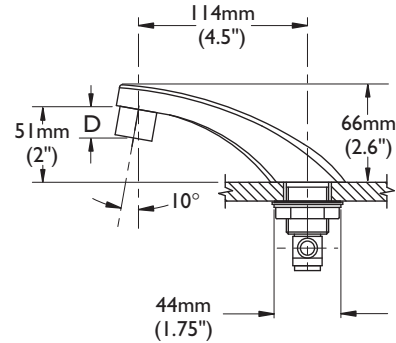

METAL POP-UP
(supplied with Product Variations 4)

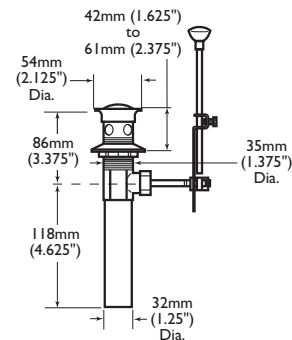

FOR OPTIONAL RIGID/SWIVEL & LIMITED SWING SPOUTS

See DSP-R/S for detailed specification

GOOSENECK SPOUT ASSEMBLIES

SPOUT/OUTLET	"A"		"C"		"L"	
	mm	in.	mm	in.	mm	in.
Gooseneck-Standard (R2) for outlets #2, 3, 4, 5	114	4.5	104	4.1	170	6.7
Gooseneck-Standard (R2) for outlet #7	114	4.5	97	3.8	178	7.0

Note: Measurements may vary ± 6mm (0.25")

Refer to www.specselect.com for individual models.

Note: Use this page front and back as a product submittal sheet.