





Features of your new air conditioner

2-step cooling

2-step cooling function will quickly cool the room to reach the desired temperature and then it will adjust the fan speed and air flow direction automatically to help you stay comfortable and refreshing.

Fast cooling/heating

If you want the strong and cool/warm air, just select Fast function! It will get you the strongest air!

Comfort cooling/heating

If you want the comfortable and refreshing air, Comfort function will spread the cool/warm air indirectly to you, so that you can stay comfortable.

Single User

Use Single User function when you are alone at home. Single User function will minimize the energy consumption with inverter technology and reduce your electricity bill by adjusting the maximum operating capacity of the compressor.

Easy Filter

There is no grille to remove before separating the filter from the air conditioner! Therefore, filter can be cleaned easily, more frequently! Frequent filter cleaning will prevent dust from entering into the product or accumulating on the filter.

good'sleep function

good'sleep function will allow you to have deep, good night's sleep by adjusting the temperature, fan speed and air flow direction.

Smart Install

When the installation is done, your product will examine itself through trial operation to check if it was installed properly.

Easy Installation

It's so easy to install! You can easily hang the product on the wall and connect the pipes and wires by opening the cover on the bottom of the product. Now you won't have to tilt the product to connect the pipe and the wires!

English-2



Contents

Preparation

Safety precautions	4
Checking before use	10
Checking the name of the parts	12
Checking the remote controller	13

Basic function

Basic function	15
Adjusting the air flow direction	18

Advanced function

Using the Fast function	19
Using the Comfort function	19
good'sleep mode	20
Setting the Current time	21
Setting the On/Off timer	21
Using the Single User function	23
Using the SPi function	23
Using the Auto Clean function	24
Using the d'light Cool function	24
Using the Quiet function	25
Using the Smart A/C application	25
Using the Filter reset	25

Others

Cleaning the air conditioner	26
Maintaining the air conditioner	29
Troubleshooting	30

Installation

Safety precautions	32
Choosing the installation location	33
Accessories	37
Fixing the installation plate	38
Disassembling/Assembling the Cover panel for indoor unit installation	39
Connecting the assembly cable	41
Installing and connecting the assembly pipe of the indoor unit	44
Evacuating the indoor unit	45
Cutting or extending the pipe	45
Installing and connecting the drain hose of the indoor unit	47
Changing direction of the drain hose	48
Installing and connecting the drain hose of the outdoor unit	49
Evacuating the connected pipes	49
Performing the gas leak tests	52
Fixing the indoor unit in place	53
Fixing the outdoor unit in place	53
Smart Install mode	54
Final check and trial operation	56
Pump down procedure (when removing the product)	56
How to connect your extended power cables	57









Safety precautions

Before using your new air conditioner, please read this manual thoroughly to ensure that you know how to safely and efficiently operate the extensive features and functions of your new appliance.

Because the following operating instructions cover various models, the characteristics of your air conditioner may differ slightly from those described in this manual. If you have any questions, call your nearest contact center or find help and information online at www.samsung.com.

Important safety symbols and precautions:

 WARNING	Hazards or unsafe practices that may result in severe personal injury or death.		
 CAUTION	Hazards or unsafe practices that may result in minor personal injury or property damage.		
	Follow directions.		Cut-off the power supply.
	Do NOT attempt.		Do NOT disassemble.
	Make sure the machine is grounded to prevent electric shock.		

FOR INSTALLATION

WARNING

 **Use the power line with the power specifications of the product or higher and use the power line for this appliance only. In addition, do not use an extension line.**

- ▶ Extending the power line may result in electric shock or fire.
- ▶ Do not use an electric transformer. It may result in electric shock or fire.
- ▶ If the voltage/frequency/rated current condition is different, it may cause fire.

The installation of this appliance must be performed by a qualified technician or service company.

- ▶ Failing to do so may result in electric shock, fire, explosion, problems with the product, or injury and may also void warranty on the installed product.

Install a Isolation Switch next to the Air Conditioner (but not on the panels of the Air Conditioner) and circuit breaker dedicated to the air conditioner.

- ▶ Failing to do so may result in electric shock or fire.

Fix the outdoor unit firmly so that the electric part of the outdoor unit is not exposed.

- ▶ Failing to do so may result in electric shock, fire, explosion, problems with the product.



- ⊘ **Do not install this appliance near a heater, inflammable material. Do not install this appliance in a humid, oily or dusty location, in a location exposed to direct sunlight and water (rain drops). Do not install this appliance in a location where gas may leak.**
 - ▶ This may result in electric shock or fire.**Never install the outdoor unit in a location such as on a high external wall where it could fall.**
 - ▶ If the outdoor unit falls, it may result in injury, death or property damage.
- ⊘ **This appliance must be properly grounded. Do not ground the appliance to a gas pipe, plastic water pipe, or telephone line.**
 - ▶ Failure to do so may result in electric shock, fire, and explosion.
 - ▶ Make sure to use a socket-outlet with ground.

FOR INSTALLATION

⚠ CAUTION

- ⓘ **Install your appliance on a level and hard floor that can support its weight.**
 - ▶ Failing to do so may result in abnormal vibrations, noise, or problems with the product.
- ⓘ **Install the draining hose properly so that water is drained correctly.**
 - ▶ Failing to do so may result in water overflowing and property damage. Avoid adding drain to waste pipes as odours may arise in the future.
- ⓘ **When installing the outdoor unit, make sure to connect the draining hose so that draining is performed correctly.**
 - ▶ The water generated during the heating operation by the outdoor unit may overflow and result in property damage.
In particular, in winter, if a block of ice falls, it may result in injury, death or property damage.

FOR POWER SUPPLY

⚠ WARNING

- ⓘ **When the circuit breaker is damaged, contact your nearest service center.**
- ⊘ **Do not pull or excessively bend the power line. Do not twist or tie the power line. Do not hook the power line over a metal object, place a heavy object on the power line, insert the power line between objects, or push the power line into the space behind the appliance.**
 - ▶ This may result in electric shock or fire.



Safety precautions

FOR POWER SUPPLY | ⚠ CAUTION

⚡ **When not using the air conditioner for a long period of time or during a thunder/lightning storm, cut the power at the circuit breaker.**

- ▶ Failing to do so may result in electric shock or fire.

FOR USING | ⚠ WARNING

⚠ **If the appliance is flooded, please contact your nearest service center.**

- ▶ Failing to do so may result in electric shock or fire.

If the appliance generates a strange noise, a burning smell or smoke, cut-off the power supply immediately and contact the nearest service center.

- ▶ Failing to do so may result in electric shock or fire.

In the event of a gas leak (such as propane gas, LP gas, etc.), ventilate immediately without touching the power line. Do not touch the appliance or power line.

- ▶ Do not use a ventilating fan.
- ▶ A spark may result in an explosion or fire.

To reinstall the air conditioner, please contact your nearest service center.

- ▶ Failing to do so may result in problems with the product, water leakage, electric shock, or fire.
- ▶ A delivery service for the product is not provided. If you reinstall the product in another location, additional construction expenses and an installation fee will be charged.
- ▶ Especially, when you wish to install the product in an unusual location such as in an industrial area or near the seaside where it is exposed to the salt in the air, please contact your nearest service center.

- ▶ Please refer to your warranty cards for terms and conditions.

⊘ **Do not touch the circuit breaker with wet hands.**

- ▶ This may result in electric shock.

Do not turn the air conditioner off with the circuit breaker while it is operating.

- ▶ Turning the air conditioner off and then on again with the circuit breaker may cause a spark and result in electric shock or fire.

After unpacking the air conditioner, keep all packaging materials well out of the reach of children, as packaging materials can be dangerous to children.

- ▶ If a child places a bag over its head, it may result in suffocation.

English-6



- ⊘ **Do not insert your fingers or foreign substances into the outlet when the air conditioner is operating.**
 - ▶ Take special care that children do not injure themselves by inserting their fingers into the product.
- Do not touch the air flow blade with your hands or fingers during the heating operation.**
 - ▶ This may result in electric shock or burns.
- Do not insert your fingers or foreign substances into the air inlet/outlet of the air conditioner.**
 - ▶ Take special care that children do not injure themselves by inserting their fingers into the product.
- Do not strike or pull the air conditioner with excessive force.**
 - ▶ This may result in fire, injury, or problems with the product.

FOR USING**⚠ WARNING**

- ⊘ **Do not place an object near the outdoor unit that allows children to climb onto the machine.**
 - ▶ This may result in children seriously injuring themselves.
- Do not use this air conditioner for long periods of time in badly ventilated locations or near infirm people.**
 - ▶ Since this may be dangerous due to a lack of oxygen, Open a window at least once an hour.
- ⊘ **If any foreign substance such as water has entered the appliance, cut-off the power supply and contact the nearest service center.**
 - ▶ Failing to do so may result in electric shock or fire.
- ⊘ **Do not attempt to repair, disassemble, or modify the appliance yourself.**
 - ▶ Do not use any fuse (such as cooper, steel wire, etc.) other than the standard fuse.
 - ▶ Failing to do so may result in electric shock, fire, problems with the product, or injury.



Safety precautions

FOR USING

⚠ CAUTION

- ❗ **Do not place objects or devices under the indoor unit.**
 - ▶ Water dripping from the indoor unit may result in fire or property damage. (example electrical appliances)**Check that the installation frame of the outdoor unit is not broken at least once a year.**
 - ▶ Failing to do so may result in injury, death or property damage.**Max current is measured according to IEC standard for safety and current is measured according to ISO standard for energy efficiency.**
- ⊘ **Do not stand on top of the appliance or place objects (such as laundry, lighted candles, lighted cigarettes, dishes, chemicals, metal objects, etc.) on the appliance.**
 - ▶ This may result in electric shock, fire, problems with the product, or injury.**Do not operate the appliance with wet hands.**
 - ▶ This may result in electric shock.**Do not spray volatile material such as insecticide onto the surface of the appliance.**
 - ▶ As well as being harmful to humans, it may also result in electric shock, fire or problems with the product.**Do not drink the water from the air conditioner.**
 - ▶ The water may be harmful to humans.**Do not apply a strong impact to the remote controller and do not disassemble the remote controller.****Do not touch the pipes connected with the product.**
 - ▶ This may result in burns or injury.**Do not use this air conditioner to preserve precision equipment, food, animals, plants or cosmetics, or for any other unusual purposes.**
 - ▶ This may result in property damage.
 - ▶ Please refer to your warranty cards for terms and conditions.**Avoid directly exposing humans, animals or plants from the air flow from the air conditioner for long periods of time.**
 - ▶ This may result in harm to humans, animals or plants.



- ⊘ This appliance is not intended for use by persons (including children) with reduced physical, sensory or mental capabilities, or lack of experience and knowledge, unless they have been given supervision or instruction concerning use of the appliance by a person responsible for their safety. Children should be supervised to ensure that they do not play with the appliance.

FOR CLEANING | ⚠ WARNING

- ⊘ Do not clean the appliance by spraying water directly onto it. Do not use benzene, thinner or alcohol to clean the appliance.
 - ▶ This may result in discoloration, deformation, damage, electric shock or fire.**Before cleaning or performing maintenance, cut-off the power supply and wait until the fan stops.**
 - ▶ Failing to do so may result in electric shock or fire.

FOR CLEANING | ⚠ CAUTION

- ⚠ **Take care when cleaning the surface of the heat exchanger of the outdoor unit since it has sharp edges.**
 - ▶ This should be done by a qualified technician please contact your installer or service center.
- ⊘ **Do not clean the inside of the air conditioner by yourself.**
 - ▶ For cleaning inside the appliance, contact your nearest service center.
 - ▶ When cleaning the internal filter, refer to the descriptions in the 'Cleaning the air conditioner' section.
 - ▶ Failure to do may result in damage, electric shock or fire.



Checking before use

Operation ranges

The table below indicates the temperature and humidity ranges the air conditioner can be operated within. Refer to the table for efficient use.

Mode	Indoor temperature	Outdoor temperature	Indoor humidity
Cooling	16 °C~32 °C	-10 °C~46 °C	Relative humidity 80% or less
Heating	27 °C or less	-15 °C~24 °C	-
Dry	18 °C~32 °C	-10 °C~46 °C	-

- ▶ If the air conditioner operates in cooling mode for long period of time in high humidity area, dew may be formed.
- ▶ If the outdoor temperature goes down to -5 °C, heating capacity may decrease as much as 60%~70 % of specified capacity according to the using conditions.

Maintaining your air conditioner

Internal protections via the unit control system

- ▶ This internal protection operates if an internal fault occurs in the air conditioner.

Type	Description
Against cold air	The internal fan will be off to prevent cold air when the heat pump is heating.
Defrost cycle	The internal fan will be off to defrost ice when the heat pump is heating. Vertical air flow blade will be closed during defrost cycle and it will open again during heating operation after defrost cycle.
Protect compressor	The air conditioner does not start operating immediately to help protect the compressor of the outdoor unit after it has been started.



NOTE

- If the heat pump is operating in Heat mode, defrost cycle is actuated to help remove frost from an outdoor unit that may have deposited at low temperatures.
The internal fan is switched off automatically and restarted only after the defrost cycle is completed.



NOTE

- A Samsung-branded air conditioning unit installed in an area which is not easily accessible (including without limitation roofs or positions above 2.4 metres for the outdoor unit) may require additional costs for labour and access equipment as may be mandated by occupational health and safety requirements. Such costs are to be borne by you should service or maintenance (including service or maintenance covered by your warranty or by a consumer guarantee) be required.



Smart install

- ▶ Through Smart install function, installer can check if the installation was done properly.
- ▶ If the installation was not done properly, error indicator will turn on the indoor unit display. Therefore user will know if the installation was done properly or not.

Checking the power consumption

This function will display the amount of electricity consumed by operating the air conditioner.

(You have to use the remote controller to check the power consumption but it will not be displayed on the remote controller display.)

Press the **2ndF** button and then press the **Usage** button on the remote controller while the air conditioner is operating.

When the air conditioner is not in use, power consumption will not be displayed on the indoor unit display even if you press the **2ndF** → **Usage** button.

- ▶ Indoor unit will display the amount of Power consumption for few seconds and then return to usual status by displaying the indoor temperature.
- ▶ Power consumption will be calculated from the moment the air conditioner is turned on and calculated value will be reset when the air conditioner turns off.
- ▶ 0.1 is the default value of the electricity consumption and 99 is the maximum value. Unit is in kWh.

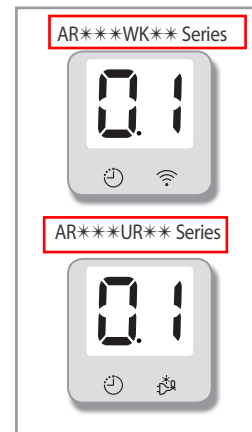



Checking the name of the parts

Your air conditioner may slightly look different from illustration shown below depending on your model.

Main parts

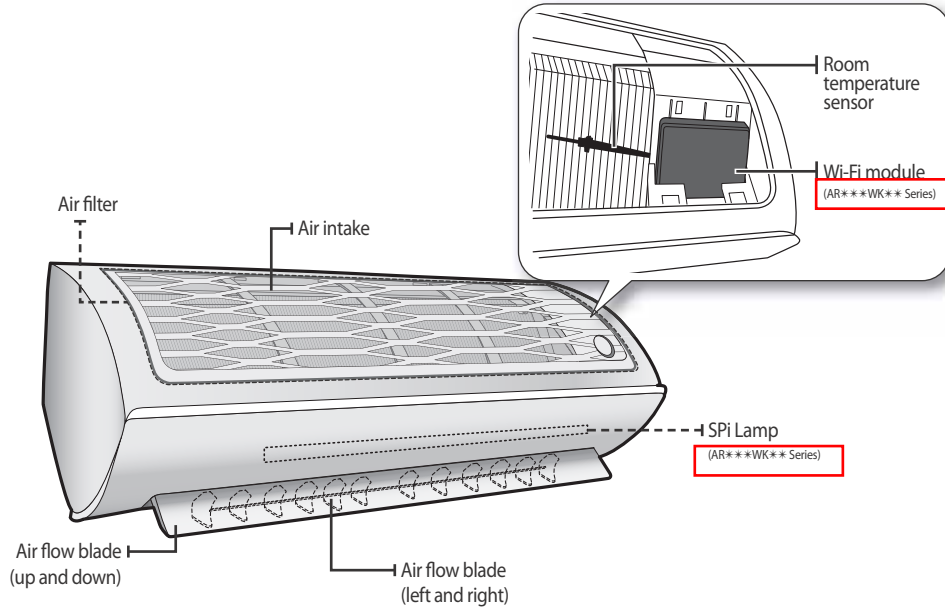

Display

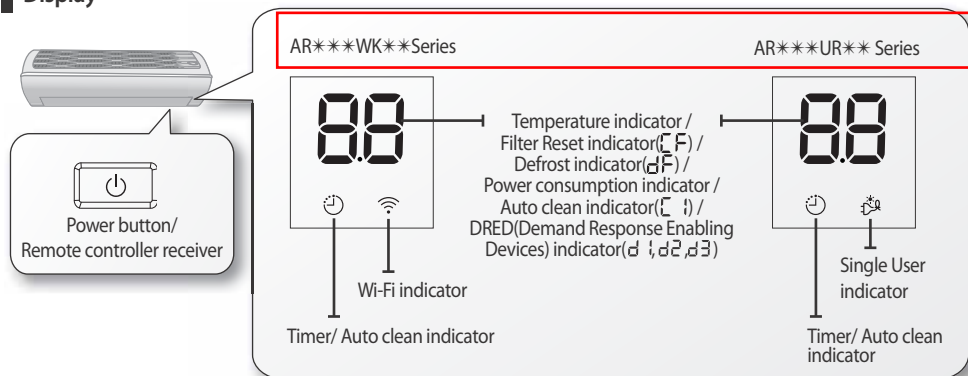



Checking the remote controller

- Point the remote controller towards the remote controller receiver of the indoor unit.
- When you properly press the button on the remote controller, you will hear beep sound from the indoor unit and a transmit indicator (📶) appears on the remote controller display.

Remote controller buttons

* Before using the functions of the remote controller, you should set the current time. (Refer to page 21)

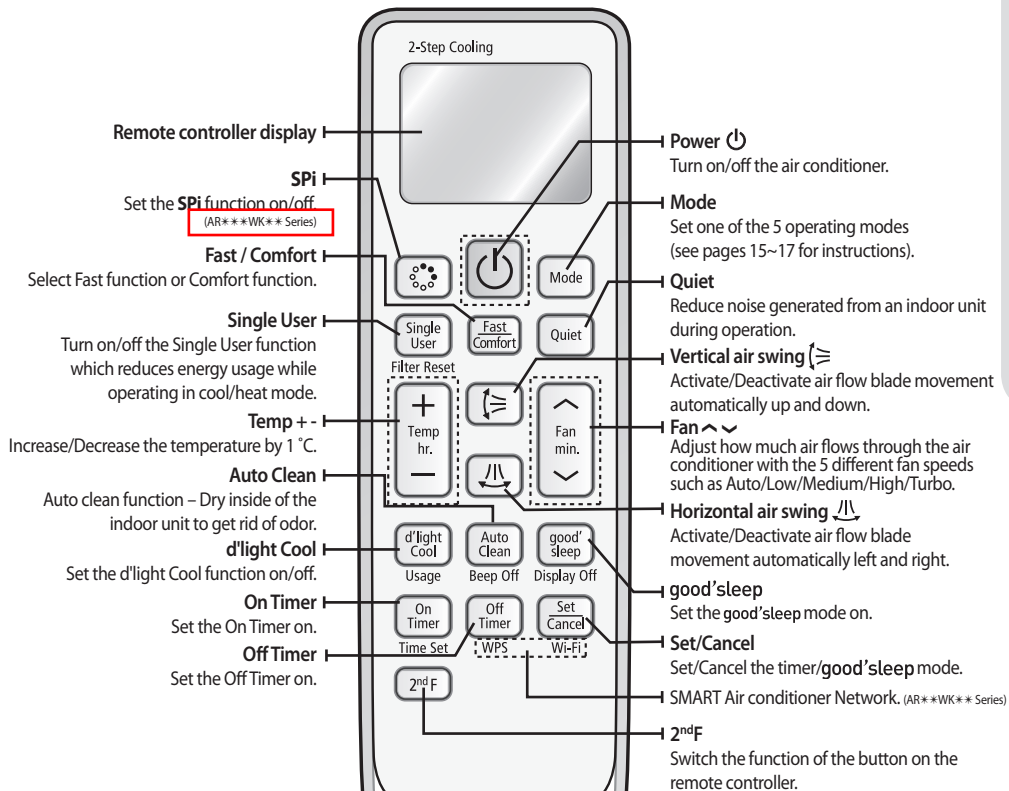

Filter Reset

Reset the Filter Clean reminder

Usage

Display the amount of power consumption for few seconds on the indoor unit display:

Beep off

To silence the beep sound when pressing the button.

Display off

To turn off the display light

Time set

Set the current time



- When you press 2ndF button, the 2ndF indicator will be displayed on the remote controller and you can change the functions on the remote controller as listed below.

Single User ▶ Filter Reset, d'light Cool ▶ Usage, Auto Clean ▶ Beep Off, good'sleep ▶ Display Off, On Timer ▶ Time Set function.

If you select the function under the button while the function of the button is switched by 2ndF button, the 2ndF function is canceled.



Checking the remote controller

Remote controller display

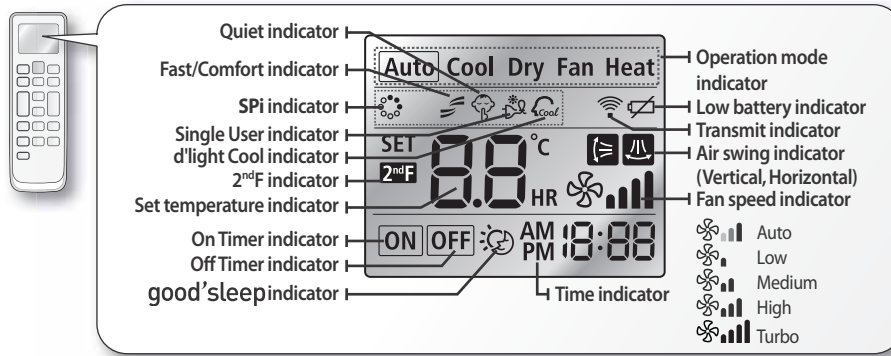

• Make sure that the water does not get to the remote controller.

Battery changing time

When the battery is exhausted, (🔋) will be displayed in the remote controller display. When the icon appears, change the batteries. The remote controller requires two 1.5 V AAA type batteries.

Storing the remote controller

When you do not use the remote controller for long time, remove the batteries from the remote controller and store it.

Inserting the batteries

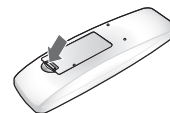

1. Push the lever as arrow indicates on the rear side of the remote controller and pull up.

2. Insert two AAA batteries.
Check and match the "+" and "-" signs accordingly. Make sure you have inserted the batteries in correct position.

3. Close the cover by place it back to its original position.
You should hear click sound when the cover is locked properly.



- The signal may not be received well of electronic lighting style fluorescent lamps such as inverter fluorescent lamps are in the same space.
- If other electrical products operate by the remote controller, call your nearest contact center.





Basic function

Basic operation is an operation mode that can be selected by pressing the **Mode** button.

Auto(2-Step Cooling or Heat)

In Auto mode, the air conditioner will automatically set the temperature and fan speed depending on the room temperature detected by the room temperature.

- 2-Step Cooling mode sets the air conditioner to operate in Fast + Cool mode when set temperature is lower than indoor temperature, and then the air conditioner will automatically operate in Dry mode when indoor temperature reaches set temperature.

Cool

In Cool mode, the air conditioner will cool your room. You can adjust the temperature and the fan speed to feel cooler in hot season.

- If current outside temperature is much higher than the selected indoor temperature, it may take time to bring the inner temperature to the desired coolness.
- Quiet mode() makes the noise quieter during the operation of the indoor unit in the Cool mode.

Dry

The air conditioner in Dry mode acts like a dehumidifier by removing moisture from the indoor air. Dry mode makes the air feel refreshing in a humid climate.

To activate the Dry mode, set temperature **on the remote controller** should be lower than indoor room temperature.

Fan

Fan mode can be selected to circulate your room. Fan mode will be helpful to refresh the stale air in your room.

Heat

The air conditioner heats as well as cools. Warm your room with this versatile appliance in the cold of winter.

- Fan may not operate for about 3~5 minutes at the beginning to prevent any cold blasts while the air conditioner is warming up.
- Quiet mode() makes the noise quieter during the operation of the indoor unit in the Heat mode.
- Since the air conditioner heats the room by taking heat energy from outdoor air, the heating capacity may decrease when outdoor temperature is extremely low.

Use an additional heating appliance in combination with the air conditioner if you feel the air conditioner heats insufficiently.



Basic function

DEMAND RESPONSE MODE (DRM 1, 2, 3)

This air conditioner is equipped with a Demand Response unit which will respond to a signal sent by the power supply utility during emergency conditions.

- During a Demand Response Event, the indoor and outdoor unit will be operated according to DRM mode (DRM 1, 2, 3) and indoor unit will show "d 1, d 2, d 3" on the display.
- In case customer has set swing mode prior to DRM 1, 2, 3 being initiated, Air flow blades will continue to swing.

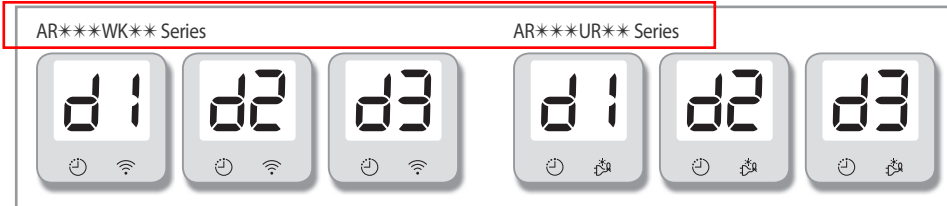

AIR CONDITIONER DEMAND RESPONSE MODES

Operational instruction (OI)	Demand response mode (DRM)*	Description of operation in this mode	Mandatory for compliance with this Standard (AS/NZS 4755.3.1)
OI 1	DRM 1	Indoor fan and Compressor off	Yes
OI 2	DRM 2	The air conditioner continues to cool or heat during the demand response event, but the electrical energy consumed by the air conditioner in a half hour period is not more than 50 % of the total electrical energy that would be consumed if operating at the rated capacity in a half hour period.	No
OI 3	DRM 3	The air conditioner continues to cool or heat during the demand response event, but the electrical energy consumed by the air conditioner in a half hour period is not more than 75 % of the total electrical energy that would be consumed if operating at the rated capacity in a half hour period.	No





Press the  button to turn on the air conditioner.





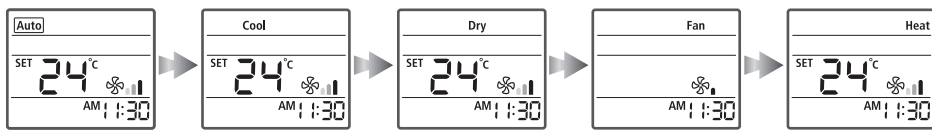











Press the  button to set the operating mode.

- Each time you press the **Mode** button, the mode will change in order of Auto, Cool, Dry, Fan and Heat.

When the Auto mode is selected, air conditioner will operate in 2-Step Cooling for cooling condition or in Auto Heat for heating condition.



Press the  button to set the desired fan speed.

Auto(2-Step Cooling or Heat)	 (Auto)
Cool	 (Auto),  (Low),  (Med),  (High),  (Turbo)
Dry	 (Auto)
Fan	 (Low),  (Med),  (High),  (Turbo)
Heat	 (Auto),  (Low),  (Med),  (High),  (Turbo)

Press the  button to adjust the temperature.

Auto(2-Step Cooling or Heat)	You can adjust the desired temperature by 1 °C within the range of 16 °C~30 °C.
Cool	You can adjust the desired temperature by 1 °C within the range of 16 °C~30 °C.
Dry	You can adjust the desired temperature by 1 °C within the range of 18 °C~30 °C.
Fan	Temperature adjustment is not possible.
Heat	You can adjust the desired temperature by 1 °C within the range of 16 °C~30 °C.



- Dry mode is only available in the cooling mode.



Adjusting the air flow direction

Air flow can be directed to your desired position.

Vertical air flow

Air flow blades move up and down.

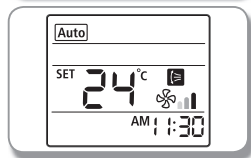

Press the **Vertical air swing**  button on the remote controller.

- ▶ Air swing indicator will be on the remote controller display and air flow blades move up and down continuously to circulate the air.
- ▶ Press the **Vertical air swing**  button on the remote controller again, to keep the air flow direction in a constant position.
- ▶ If you adjust the vertical air flow blade manually, it may not close completely when you turn off the air conditioner.



- Adjusting the air flow direction is not available in good'sleep mode while it is in cool mode.
- However, you can adjust the air flow direction in good'sleep mode while it is in heat mode.

Horizontal air flow

Air flow blades move left and right.

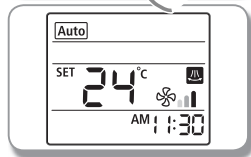
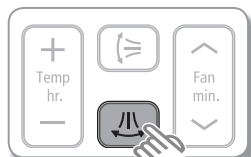

Press the **Horizontal air swing**  button on the remote controller.

- ▶ Air swing indicator will be on the remote controller display and air flow blades move left and right continuously to circulate the air.
- ▶ Press the **Horizontal air swing**  button on the remote controller again, to keep the air flow direction in a constant position.
- ▶ If you adjust the horizontal air flow blade manually, it may not operate normally.



- Adjusting the air flow direction is not available in good'sleep mode while it is in cool mode.
- However, you can adjust the air flow direction in good'sleep mode while it is in heat mode.



Using the Fast function

You can set the Fast function to provide powerful cooling/heating.

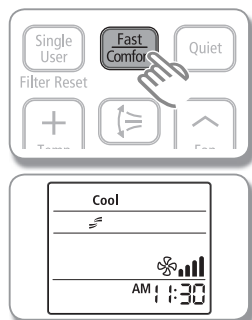

Press the **Fast/Comfort** button on the remote controller once to select Fast function.

- ▶ Fast indicator () appears on the remote controller display and the air conditioner operates in Fast function for 30 minutes.
- ▶ When you select Fast function, your air conditioner will operate more powerfully to quickly cool or warm your room.

Cancel Press the **Fast/Comfort** button twice when the Fast function is on.



NOTE

- Fast function is only available in Cool/Heat mode.
- If you press the **Mode** button while the Fast function is on, it will cancel the function.
- Temperature/Fan speed cannot be adjusted when the function is on.
- When you select Fast function in Heat mode, you may not be able to increase fan speed in order to prevent any cool air from blowing.

Using the Comfort function

You can set the Comfort function to provide mild cooling/heating.

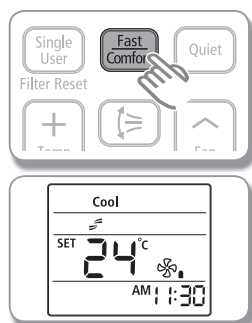

Press the **Fast/Comfort** button on the remote controller twice to select Comfort function.

- ▶ Comfort indicator () appears on the remote controller display.
- ▶ When you select Comfort function, your air conditioner will operate mildly to provide you comfort cooling/heating.

Cancel Press the **Fast/Comfort** button once when the Comfort function is on.



NOTE

- Comfort function is only available in Cool/Heat mode.
- If you press the **Mode** button while the Comfort function is on, it will cancel the function.
- You can adjust the temperature but fan speed cannot be adjusted when the function is on.





good'sleep mode

Before using good'sleep mode, set the current time. (For setting current time, refer to the page 21.)

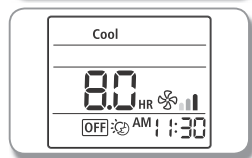
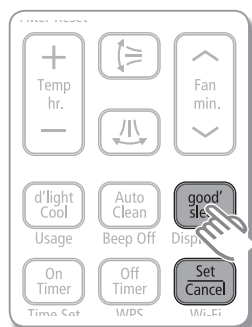

For a comfortable sleep, the air conditioner will operate it Fall asleep ▷ Sound sleep ▷ Wake up from **good'sleep** mode.

When the air conditioner is on and in cool/heat mode



1. Press the **good'sleep** button on the remote controller.
 - ▶ **good'sleep** indicator appears and Off timer indicator starts blinking on the remote controller display.
2. Press the **good'sleep** button to set the time.
 - ▶ You can set the time in half hourly unit from 30 minutes ~ 3 hours and hour unit from 3 hours ~ 12 hours.
 - ▶ Operating hour can be set from minimum 30 minutes to maximum 12 hours.
 - ▶ Default operation hour is set to 8 hours.
3. Press the **Set/Cancel** button to activate it.
 - ▶ Off timer indicator stops blinking and reserved time will be displayed for 3 seconds. Then the air conditioner operates in good'sleep mode.
 - ▶ If you don't press **Set/Cancel** button within 10 seconds after pressing the **good'sleep** button, the air conditioner will return to previous status. Check Off timer indicator on the remote controller display and  indicator on the indoor unit.

Cancel Press the **Set/Cancel** button once again.

	You can set the desired temperature by 1 °C in the range of 16 °C~30 °C.
	Fan speed will be adjusted automatically according to the good'sleep mode. However, if you select good'sleep mode while heating operation is on, you can adjust fan speed.
	When the good'sleep mode is on. In Cool mode: Air flow direction will be adjusted automatically. In Heat mode: Adjusting air flow direction is available.

Temperature and fan speed change in good'sleep mode

- Fall asleep: Eases you into sleep by dropping the temperature.
- Sound sleep: Relaxes your body and raises your temperature slightly.
- Wake up from **good'sleep** mode: Allows you to wake up from comfortable intermittent air and it makes you feel refreshed.



- Set Off timer in **good'sleep** mode over 5 hours. You fell disturbed sleep if the **good'sleep** is set too short or long because the default is set to 8-hour-operation.
- If the **good'sleep** mode is set less than 4 hours, the operation will stop at the same time.
If the **good'sleep** mode is set over 5 hours, it will run as Wake up stage from the last one hour before it stops.
- Recommended set temperature is between 25 °C~27 °C for cooling and 21 °C~23 °C for heating.





Setting the Current time

Before using the functions of the air-conditioner, set the current time.

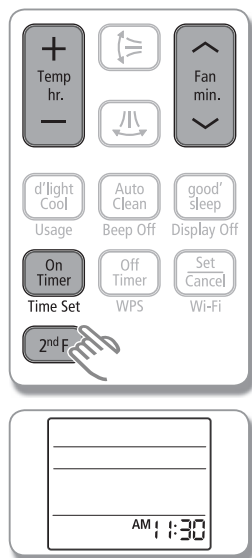

1. Press the **2ndF** button
 - ▶ 2ndF indicator appears on the remote controller display.
2. Press the **Time Set** button to set the current time
 - ▶ AM or PM indicator will blink and you can set the time by pressing **Temp hr.** + or - button for hour and **Fan min.** ^ v button for minute.
3. Press the **Time Set** button again to activate it.

Setting the On/Off timer



- Check the current time on the remote controller before using this function.
- The default time is 12 AM on the remote controller. The current time is reset to default time after changing the batteries.

You can set the air conditioner to turn on/off automatically at desired time.

Setting On timer while the air conditioner is off / Off timer while the air conditioner is on

Setting On timer

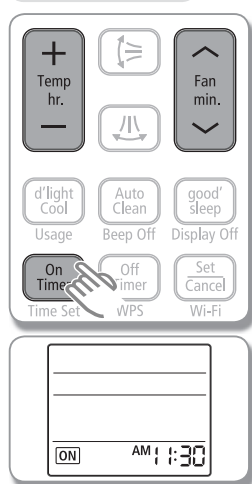

1. Press the **On Timer/Off Timer** button.
 - ▶ On/Off timer indicator will blink on the remote controller display.
2. Press the **Temp hr.** + or - button and **Fan min.** ^ v button to set the time.
 - ▶ You can set the time in hourly units from 1 hour ~ 12 hours according to AM, PM and in minute units from 1 minute ~ 59 minutes.

Setting the On/Off timer

Setting Off timer

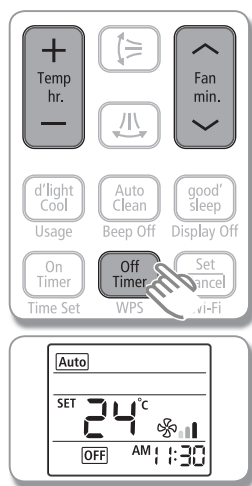



3. Press the **Set/Cancel** button to activate it.

- ▶ On timer indicator stops blinking and reserved time will be displayed for 3 seconds.
- ▶ If you don't press **Set/Cancel** button within 10 seconds after selecting the time the air conditioner will return to previous status. Check On timer or Off timer indicator on the remote controller display and  indicator on the indoor unit.

Cancel Press the **Set/Cancel** button once again.

Additional options available in On/Off timer mode (When the remote controller is on)

	Displays the last mode set before turning the unit off.
	You can adjust the temperature in Auto/Cool/Dry/Heat mode.
	You can adjust the fan speed in Cool/Fan/Heat mode.

Setting on timer and off timer simultaneously

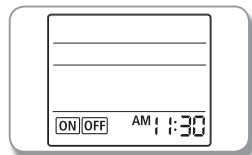

- NOTE** Only the latest setting timer will be applied between the On Timer / OffTimer and good'sleep functions.

Follow the same process for setting on timer and off timer.

- NOTE**
- On timer and Off timer setting time should be different from each other.
 - Press the **Set/Cancel** button on the remote controller while timer combination is on. Both of the On and Off timer will be canceled and the indicator will disappear.



Using the Single User function

This function will reduce the energy usage while the air conditioner is operating in Cool/Heat mode.

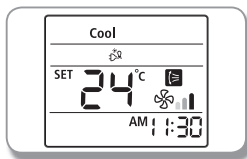
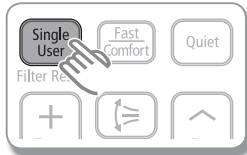

Press the **Single User** button on the remote controller while the air conditioner is operating in Cool/Heat mode.

- ▶ "-----" appears on the remote controller display for few seconds and disappears.
- ▶ Single User indicator and air swing () indicator appear automatically on the remote controller display.
The air flow blades move up and down.
- ▶ If the current set temperature is lower than 24°C in Cool mode, it will be automatically raised to 24°C.

Cancel Press the **Single User** button once again.



- Single User function is only available in Cool/Heat mode.
- When Single User function is activated in Cool mode, temperature range will be limited to 24°C~30°C. However, temperature range during Heat mode will remain same at 16°C~30°C.
- If the desired temperature is lower than 24°C in Cool mode, turn off the Single User function by pressing the **Single User** button again.
- Temperature/Fan speed can also be adjusted (see page 17 for instructions).
- Air flow can be adjusted. (see page 18 for instruction).
- If you press the **Mode** button while the Single User function is on, it will cancel the function.

Using the SPi function

This function will produce positive ions and supply them into the airflow. (Applicable model: AR***WK**Series)

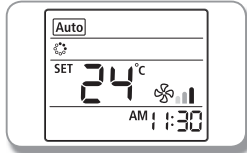
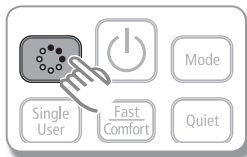

Press the **SPi** button on the remote controller.

- ▶ SPi indicator will appear on the remote controller display and the air conditioner generates SPi.
- ▶ SPi Lamp on the indoor unit will turn on when the SPi function is on and it will turn off when the function is canceled.

Cancel Press the **SPi** button once again.



- The SPi function can be selected whether the air conditioner is on/off.
- The SPi function may not be available for some models.

Using the Auto Clean function

Auto clean function will minimise the moisture inside of the indoor unit. Activate this function to help provide you with clean air.

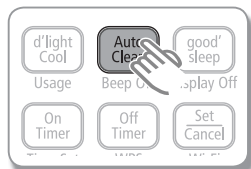

AR***WK** Series



AR***UR** Series



Press the **Auto Clean** button.

When the air conditioner is turned off,

- ▶ The Auto clean indicator on the indoor unit display appears and the Auto clean function runs.

When the air conditioner is turned on,

- ▶ After stopping the air conditioner operation, the Auto clean indicator on the indoor unit display appears and the Auto clean function runs.

Auto Clean time can vary, depending on the previously used mode.

Auto(cool), Cool, Dry mode : approximately 30 minutes.

Auto(heat), Heat, Fan mode : approximately 15 minutes.

Cancel Press the **Auto clean** button once again.



- During the auto clean function, indoor fan will continue to run and air flow blade will remain open to expel ambient air.

Using the d'light Cool function

This function will let the air conditioner select the operation mode automatically from Cool/Dry/Fan mode to provide refreshing air. When the function is selected, air conditioner will operate in Cool mode for 10 minutes and change to appropriate operation mode according to surrounding environment.

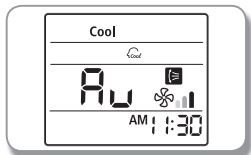
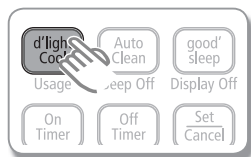

Press the **d'light Cool** button on the remote controller while the air conditioner is operating in **Cool mode**.

- ▶ d'light Cool indicator and air swing () indicator appear automatically on the remote controller display.
- ▶ The air conditioner will set the temperature to auto and adjust the fan speed automatically according to the room temperature.

Cancel Press the **d'light Cool** button once again.



- d'light Cool function is only available in Cool mode.
- When d'light Cool function is activated, temperature sets automatically and **Au** will appear on the remote controller display.
- If you press the **Mode** button while the d'light Cool function is on, it will cancel the function.



Using the Quiet function

You can reduce the noise generated from an indoor unit.

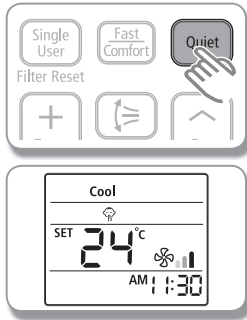

Press the **Quiet** button on the remote controller while the air conditioner is operating in Cool/Heat mode.

- ▶ Quiet indicator appears on the remote controller display.
- ▶ The indoor unit will operate more quietly.

Cancel Press the **Quiet** button once again.

- NOTE**
- If using a multi system, this function will work only when the Quiet function is set on all operated indoor units.

Using the Smart A/C application

You can conveniently control your air conditioner anywhere with Smart APP. (Applicable model: **AR***WK**** Series)

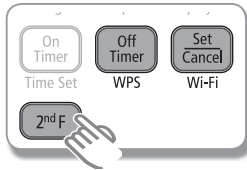

- NOTE**
- For detail information, please refer to Smart A/C application manual.
 - Smart A/C application may not be available for some models.

Using the Filter reset

Filter clean reminder (CF) will light up on the indoor unit display to notify you that the filter needs cleaning.

After cleaning the filter, press the **2nd F** button and then press the **Single User** button to reset the Filter clean reminder. Filter clean reminder will be turned off.

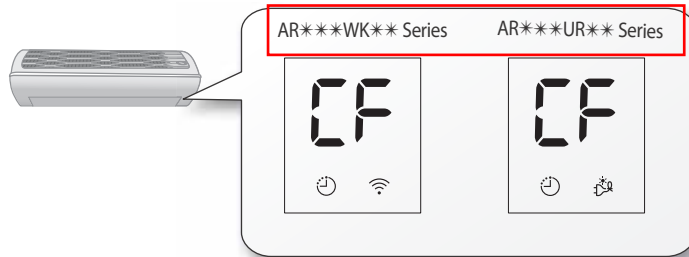
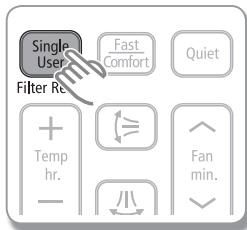



Cleaning the air conditioner



- **Make sure to turn off the power of the indoor unit and cut-off the power supply before cleaning the air conditioner.**

Cleaning the indoor unit

- ▶ Wipe the surface of the unit with a slightly damp micro fiber cloth when needed.



- Contact the service center when you clean the indoor unit heat exchanger because it needs to be disassembled.
- Since the panel of the indoor unit is easily scratched, you should use a micro fiber cloth to clean the panel. When you use the micro fiber cloth, slightly dampen the cloth and remove any debris on the cloth to avoid scratches.

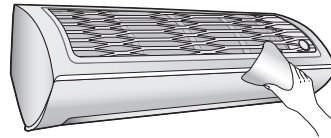

- Do not clean the display using alkaline detergent.
- Do not use sulfuric acid, hydrochloric acid, organic solvents (such as thinner, kerosene and acetone etc.) to clean the surface of the product or put any stickers on it. They may damage the surface of the air conditioner.

Cleaning the outdoor unit heat exchanger

- ▶ When dust accumulates on the heat exchanger, it may decrease cooling performance. Therefore, clean it regularly.
- ▶ Spray water to clean the dust.



- If it is difficult to clean the outdoor unit heat exchanger on your own, contact service center.



- Be careful with the sharp edges on the outdoor unit heat exchanger.

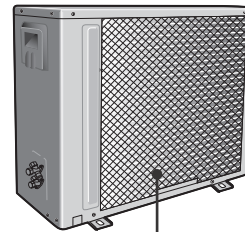

Heat exchanger

(Illustration may differ slightly depending on the models)



Removing the Air filter

There is a hole on the bottom right side of the filter. Put your finger in that hole to get a grip on the filter and slightly push it up to release the hooks from the bottom side. Then, pull it down to remove the filter from the main body.

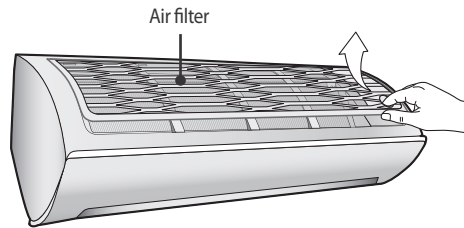

04 OTHERS

Cleaning the Air filter

Washable foam based air filter captures large particles from the air. The filter is cleaned with a vacuum or by hand washing.

Remove the Air filter from the main body.

Clean the Air filter with a vacuum cleaner or soft brush. If dust is too heavy, rinse it with running water.

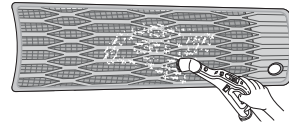

Insert the Air filter back in its original position.

Dry the Air filter in a ventilated area.

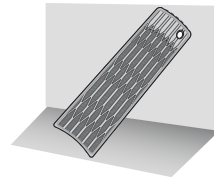

- Clean the Air filter every 2 weeks. Cleaning term may differ depending on the usage and environmental conditions. In dusty area, clean it once a week.
- If the Air filter dries in a confined (or humid) area, odors may generate. If it occurs, re-clean and dry it in a well-ventilated area.
- When the filter clean reminder is on, please press the 2nd F button and then press the **Single User** button on remote controller.



Cleaning the air conditioner

Reassembling the Air filter

1. Put the filter on the main body and insert the hooks which are in the bottom of the Air filter into the bottom of the main body. ①

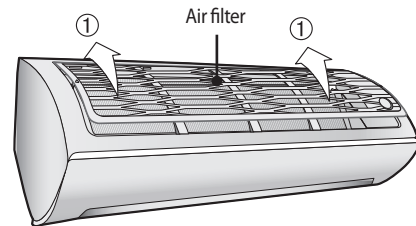

2. There's one hook in both side of the filter, press the surface of the Air filter softly and get the hooks into the main body. ②

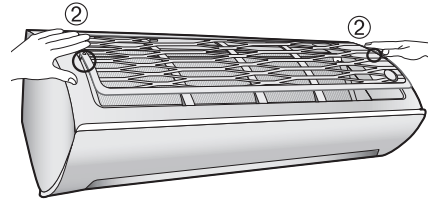

3. Press the top of the filter lightly to securely fix the main body. ③④⑤

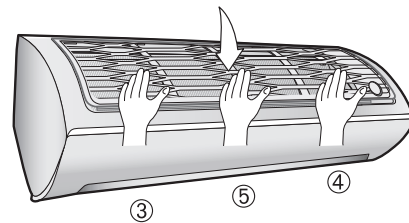



Maintaining the air conditioner

If the air conditioner will not be used for an extended period of time, dry the air conditioner to maintain it in best condition.

1. Dry the air conditioner thoroughly by operating in Fan mode for 3 to 4 hours and cut-off the power supply. There may be internal damage if moisture is left in components.
2. Before using the air conditioner again, dry the inner components of the air conditioner again by running in Fan mode for 3 to 4 hours. This helps remove odors which may have generated from dampness.

04 OTHERS

Periodical checks

Refer to the following chart to maintain the air conditioner properly.

Type	Description	Every 2 weeks	Every 3 months	Every 4 months	Once a year
Indoor unit	Clean the Full HD filter (1)	●			
	Clean the condensate drain pan (2)				●
	Thoroughly clean the heat exchanger (2)				●
	Clean the cross fan (2)			●	
	Clean the condensate drain pipe (2)			●	
	Replace the remote controller batteries (1)				●
Outdoor unit	Clean the heat exchanger on the outside of the unit (2)			●	
	Clean the heat exchanger on the inside of the unit (2)				●
	Clean the electric components with jets of air (2)				●
	Verify that all the electric components are firmly tightened (2)				●
	Clean the fan (2)				●
	Verify that all the fan assembly is firmly tightened (2)				●
	Clean the condensate drain pan (2)				●

● : This check mark requires checking the indoor/outdoor unit periodically.
Follow the description to maintain the air conditioner properly.



- (1) The described operations should be performed more frequently if the area of installation is very dusty.
- (2) These operations must always be performed by qualified personnel. For more detailed information, see the installation part in the manual.





Troubleshooting

Refer to the following chart if the air conditioner operates abnormally. This may save time and unnecessary expenses.

PROBLEM	SOLUTION
The air conditioner does not work at all.	<ul style="list-style-type: none">• Check power status and then operate the air conditioner again.• Plug in or switch on the circuit breaker and then operate the air conditioner again.• Ensure Isolator is switch on.• Check if you have set the Off Timer. Operate the air conditioner again by pressing the Power button.
The temperature adjustment is not working.	<ul style="list-style-type: none">• Check if you have selected Fan/Fast mode. In these modes, desired temperature is set to auto and you cannot adjust the temperature.
Cool/Warm air does not come out of the air conditioner.	<ul style="list-style-type: none">• Check if the set temperature is higher(during Cool mode)/ lower(during Heat mode) than the current temperature. Press the Temp + or - button on the remote controller to change the set temperature.• Check if the Air filter is blocked by dirt. If there is a lot of dust on the Air filter, cooling(heating) performance may decrease. Clean them frequently.• Check if the outdoor unit is covered or installed near the obstacle. Take the cover off and take the obstacle away.• Check if the air conditioner is operating in defrost mode. When the ice formed in winter or the outdoor temperature is too low, the air conditioner operates in defrost mode automatically. In defrost mode, indoor fan stops and warm air does not come out.• If the doors or windows are open, it may cause bad cooling (heating) performance. Close the doors and windows.• Check if the air conditioner has just been turned on after stopping cooling or heating operation. In this case, just a fan will run to protect the outdoor unit compressor.• Check if the pipe length is too long. When the pipe length exceeds maximum allowable pipe length, cooling (heating) performance may decrease.
Air flow adjustment is not working.	<ul style="list-style-type: none">• Check if you have selected good'sleep mode. In this mode, you cannot adjust the air flow direction. (If the good'sleep mode is operating in Heat mode, you can adjust the air flow direction.)



PROBLEM	SOLUTION
Fan speed adjustment is not working.	<ul style="list-style-type: none"> Check if you have selected Auto/Dry/Fast/good'sleep mode. In these mode, fan speed is set to Auto and you cannot adjust the fan speed.
Remote controller is not working.	<ul style="list-style-type: none"> Check if your batteries are depleted. Make sure nothing is blocking your remote controller sensor. Check that there are strong lighting apparatus near the air conditioner. Strong light which comes from fluorescent bulbs or neon signs may interrupt the electric waves.
Timer function does not set.	<ul style="list-style-type: none"> Check if you press the Set/Cancel button on the remote controller after you have set the time.
The indicator is blinking continuously.	<ul style="list-style-type: none"> Press the Power  button or disconnect the power plug/switch off the auxiliary power switch. If the indicator is still blinking, contact the service center.
Odors permeate in the room during operation.	<ul style="list-style-type: none"> Check if the appliance is running in a smoky area. Ventilate the room or operate the air conditioner in Fan mode for 1~2 hours. (We do not use smelly components in the air conditioner.) Check the Drains have been cleared Regular Maintenance.
Error is indicated.	<ul style="list-style-type: none"> When an indoor unit indicator blinks, contact the nearest service center. Please ensure the error code is passed onto the service center when booking the service call.
Noise is generated.	<ul style="list-style-type: none"> Depending on the status of the air conditioner usage, noise can be heard when refrigerant flow movement changes. It is normal.
Smoke is generated from the outdoor unit.	<ul style="list-style-type: none"> If may not be a fire but it can be a steam generated by the defrost operation from outdoor heat exchanger during Heat mode in winter.
Water is dropping from the outdoor unit piping connection.	<ul style="list-style-type: none"> Water may be generated because of the temperature difference. It is normal.
Indoor unit display indicates "d 1, d2, d3"	<ul style="list-style-type: none"> This is not a defect. If the air conditioner receives a Demand Response signal from the power supply utility, then the compressor and fans will be operated according to DRM mode(DRM 1, 2,3). The indoor unit display will indicate "d 1, d2, d3". <p>* see page 16 for more details about DRM mode.</p>



Safety precautions

Carefully follow the precautions listed below because they are essential to guarantee the safety of the equipment.

- Always disconnect the air conditioner from the power supply before servicing it or accessing its internal components.
- Verify that installation and testing operations are performed by qualified personnel.
- Verify that the air conditioner is not installed in an easily accessible area.

General information

- ▶ Carefully read the content of this manual before installing the air conditioner and store the manual in a safe place in order to be able to use it as reference after installation.
- ▶ For maximum safety, installers should always carefully read the following warnings.
- ▶ Store the operation and installation manual in a safe location and remember to hand it over to the new owner if the air conditioner is sold or transferred.
- ▶ This manual explains how to install an indoor unit with a split system with two SAMSUNG units. The use of other types of units with different control systems may damage the units and invalidate the warranty. The manufacturer shall not be responsible for damages arising from the use of non compliant units.
- ▶ This product has been determined to be in compliance with the Low Voltage Directive (2006/95/EC), and the Electromagnetic Compatibility Directive (2004/108/EC) of the European Union.
- ▶ The manufacturer shall not be responsible for damage originating from unauthorized changes or the improper connection of electric and requirements set forth in the "Operating limits" table, included in the manual, shall immediately invalidate the warranty.
- ▶ The air conditioner should be used only for the applications for which it has been designed: the indoor unit is not suitable to be installed in areas used for laundry.
- ▶ Do not use the units if damaged. If problems occur, switch the unit off and disconnect it from the power supply.
- ▶ In order to help prevent electric shocks, fires or injuries, always stop the unit, disable the protection switch and contact SAMSUNG's technical support if the unit produces smoke, if the power cable is hot or damaged or if the unit is very noisy.
- ▶ Always remember to inspect the unit, electric connections, refrigerant tubes and protections regularly. These operations should be performed by qualified personnel only.
- ▶ The unit contains moving parts, which should always be kept out of the reach of children.
- ▶ Do not attempt to repair, move, alter or reinstall the unit. If performed by unauthorized personnel, these operations may cause electric shocks or fires.
- ▶ Do not place containers with liquids or other objects on the unit.
- ▶ All the materials used for the manufacture and packaging of the air conditioner are recyclable.
- ▶ The packing material and exhaust batteries of the remote controller(optional) must be disposed of in accordance with current laws.
- ▶ The air conditioner contains a refrigerant that has to be disposed of as special waste. At the end of its life cycle, the air conditioner must be disposed of in authorized centers or returned to the retailer so that it can be disposed of correctly and safely.



Installing the unit

IMPORTANT: When installing the unit, always remember to connect first the refrigerant tubes, then the electrical lines.
Always disassemble the electric lines before the refrigerant tubes.

- ▶ Upon receipt, inspect the product to verify that it has not been damaged during transport.
If the product appears damaged, DO NOT INSTALL it and immediately report the damage to the carrier or retailer (if the installer or the authorized technician has collected the material from the retailer.)
- ▶ After completing the installation, always carry out a functional test and provide the instructions on how to operate the air conditioner to the user.
- ▶ Do not use the air conditioner in environments with hazardous substances or close to equipment that release free flames to avoid the occurrence of fires, explosions or injuries.
- ▶ To help prevent injury when accidentally touching the indoor unit fan, install the indoor unit at least 2.5 m above the floor.
- ▶ The air conditioner should be used only for the applications for which it has been designed : the indoor unit is not suitable to be installed in areas used for laundry.
- ▶ Our units must be installed in compliance with the spaces indicated in the installation manual to ensure either accessibility from both sides or ability to perform routine maintenance and repairs. The units' components must be accessible and that can be disassembled in conditions of complete safety either for people or things.
For this reason, where it is not observed as indicated into the Installation Manual, the cost necessary to reach and repair the unit (in safety, as required by current regulations in force) with slings, trucks, scaffolding or any other means of elevation won't be considered in-warranty and charged to end user.

Power supply line, fuse or circuit breaker

- ▶ Always make sure that the power supply is compliant with current safety standards. Always install the air conditioner in compliance with current local safety standards.
- ▶ Always verify that a suitable grounding connection is available.
- ▶ Verify that the voltage and frequency of the power supply comply with the specifications and that the installed power is sufficient to ensure the operation of any other domestic appliance connected to the same electric lines.
- ▶ Always verify that the cut-off and protection switches are suitably dimensioned.
- ▶ Verify that the air conditioner is connected to the power supply in accordance with the instructions provided in the wiring diagram included in the manual.
- ▶ Always verify that electric connections (cable entry, section of leads, protections...) are compliant with the electric specifications and with the instructions provided in the wiring scheme.
Always verify that all connections comply with the standards applicable to the installation of air conditioners.

Choosing the installation location

Indoor unit

- ▶ For Wi-Fi Air-conditioner installation, select indoor unit location near to wireless router.
In case Wi-Fi signal strength weakened, Smart APP may be disconnected depending on the Wi-Fi signal strength.
- ▶ Where airflow is not blocked.
- ▶ Where cool air can be distributed throughout the room.
- ▶ Install the refrigerant piping length and the height difference of both indoor and outdoor units as indicated in the installation diagram.
- ▶ Wall that prevents vibration and is strong enough to hold the product weight.
- ▶ Out of the direct sunlight.
- ▶ 1 m or more away from the TV or radio (to prevent the screen from being distorted or noise from being generated).
- ▶ As far away as possible from the fluorescent and incandescent lights (so that the remote controller can be operated well).
- ▶ A place where the air filter can be replaced easily.
- ▶ Don't install directly above electronics equipment as leaking water may cause damage if not serviced. (eg. Computers, TV, etc).

Choosing the installation location

Outdoor Unit

- ▶ Where it is not exposed to strong wind
- ▶ Well ventilated and dustless places
- ▶ Where possible keep out of sunlight and rain
- ▶ Where neighbors are not annoyed by operation sound or hot air
- ▶ Solid wall or support that prevents vibration and is strong enough to hold the product weight
- ▶ Where there is no risk of flammable gas leakage
- ▶ When installing the unit at a high place be sure to fix the unit legs
- ▶ 3 m or more away from the TV or radio (to prevent the screen from being distorted or noise from being generated)
- ▶ Install the unit horizontally
- ▶ Place where drained water does not become any problem.
- ▶ Place with no plants (especially climbing plants) and where small animal can not access.
- ▶ Outdoor unit should not be place higher than 2.4 m or directly under eaves for accessibility for service and OH&S reasons.



- Avoid the following places to prevent malfunction of the unit
 - Where there is machine oil
 - Salty environment such as seaside areas
 - Where sulfide gas exists
 - Other special atmosphere areas

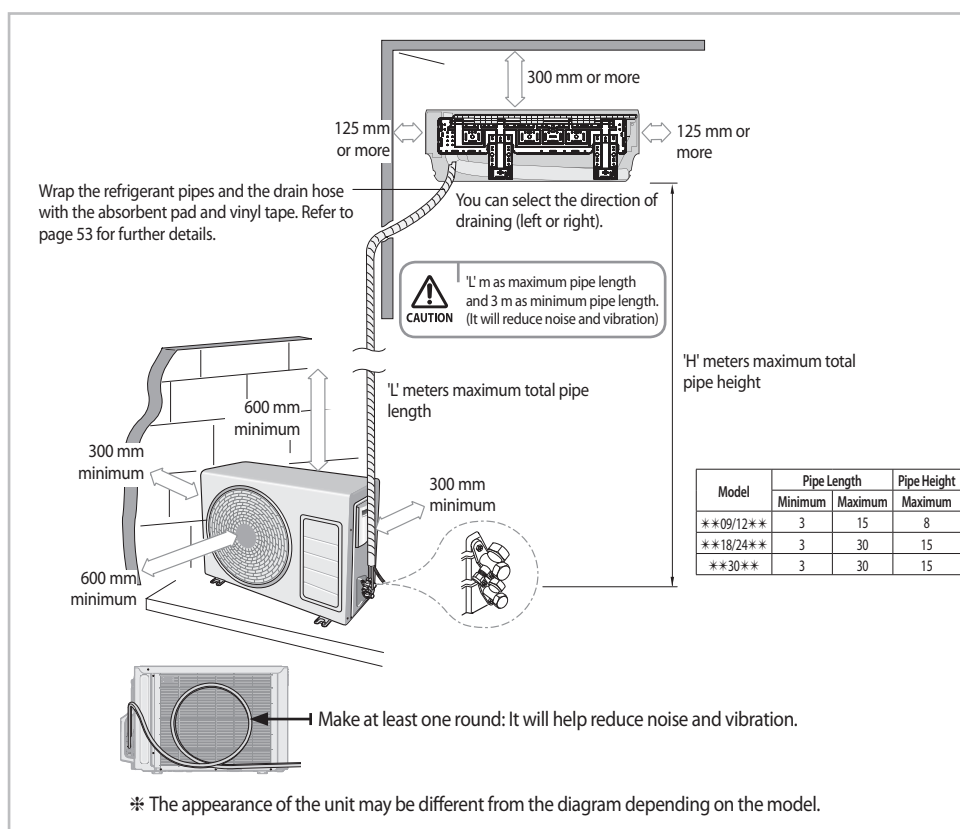

English-34



Space Requirements for Outdoor Unit

When installing 1 outdoor unit

◆ Figure Description

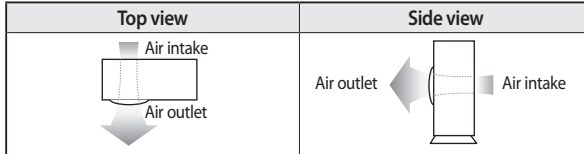

- ◆ Air flow direction.

(Unit : mm)

- ◆ When the air outlet is opposite the wall

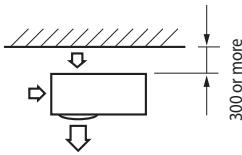

- ◆ When the air outlet is towards the wall

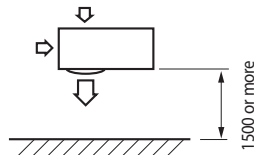

- ◆ When 3 sides of the outdoor unit are blocked by the wall

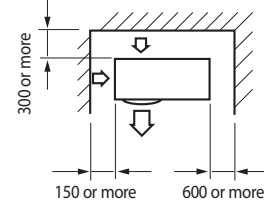

- ◆ The upper part of the outdoor unit and the air outlet is towards the wall

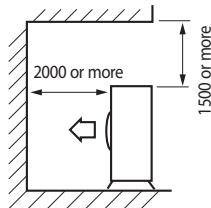

- ◆ The upper part of the outdoor unit and the air outlet is opposite the wall

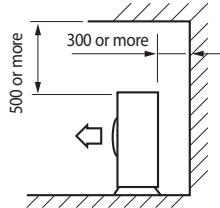

- ◆ When the walls are blocking front and the rear side of the outdoor unit

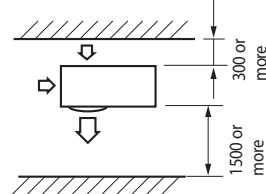



Choosing the installation location

When installing more than 1 outdoor unit

(Unit : mm)

◆ When the air outlet is towards the wall

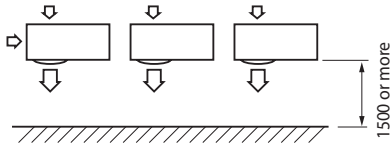

◆ When 3 sides of the outdoor unit are blocked by the wall

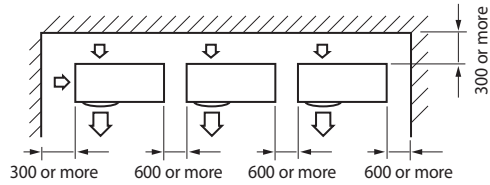

(Unit : mm)

◆ When the walls are blocking front and the rear side of the outdoor units

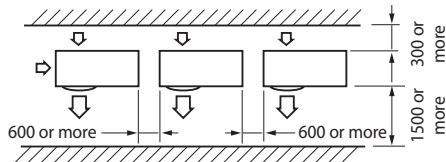

◆ When the upper part of the outdoor unit and the air outlet is opposite the wall

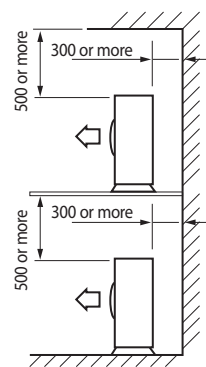

◆ When front and rear side of the outdoor unit is towards the wall

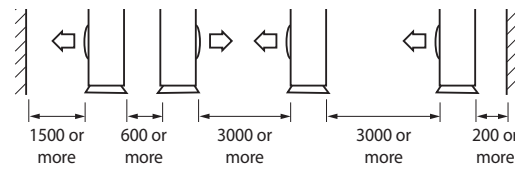

- If installation is done in inappropriate space, unit may generate sound and cause bad effect on the product.
- Installation must be done in level and in a place where vibration will not cause any effect.













Accessories

The following accessories are supplied with the air conditioner:







- The number of each accessory is indicated in parentheses.

Accessories in the indoor unit case

Installation Plate (1) **09/12** (04 frame) 	Installation Plate (1) **18/24/30** (05 frame) 	Remote controller (1) 	Batteries for Remote controller (2) 	User's & Installation Manual (1) 
Wi-Fi Manual (1) 	Remote Control Holder (1) 	M4 x 16 Tapped Screws (2) 	M4 x 10 Tapped Screws (2) 	Cap Screws (3) 

Accessories in the outdoor unit case

Drain Plug (1) 	Rubber Leg (4) 	Guide Right (1) 	Guide Left (1) 
---	---	--	---



- The flare nuts are attached to the end of each pipe of an evaporator or a service port. Use the nuts when connecting the pipes.
- The drain plug and rubber leg are only included when the air conditioner is supplied without the assembly pipe as seen in the picture below.

Tools required for installation

General Tools

- Vacuum Pump (Backward flowing prevention)
- Torque Wrench
- Screw Driver
- Pipe Cutter
- Spanner
- Reamer
- Drill
- Manifold Gauge
- Pipe Bender
- L Wrench
- Stud Finder
- Spirit Level
- Measuring Tape

Tools for test operations

- Thermometer
- Resistance Meter
- Electroscope



Fixing the installation plate

You can select the direction of the drain hose depending on where you want to install the indoor unit. Therefore before fixing the installation plate to a wall or a window frame, you must determine the position of the 65 mm hole through which the cable, pipe and hose pass to connect the indoor unit to the outdoor unit.

When facing the wall, the pipe and cable can be connected from the:

- Right (A)
- Left (B)
- Underside_right (C)
- Rear_right or left (D)

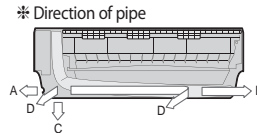

1. Determine the position of the pipe and drain hose hole as seen in the picture and drill the hole with an inner diameter of 65 mm so that it slants slightly downwards.

Pipe hole (Ø65 mm)

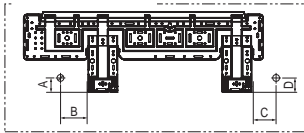

Pipe hole (Ø65 mm)

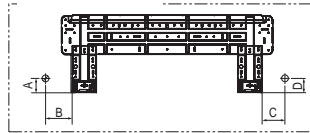

(Unit : mm)

Model	A	B	C	D
09/12	0	241	30	0
18/24/30	5	161	52	5



- Make sure to drill only one hole after choosing the direction of the pipe.

2. Fix the indoor unit.

If you fix the indoor unit on a wall

- (1) Fix the installation plate to the wall giving attention to the weight of the indoor unit.



- If you mount the plate to a concrete wall using plastic anchors, make sure that gaps between the wall and the plate, created by projected anchor, is less than 20 mm.

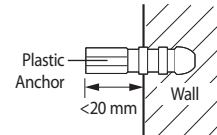

If you fix the indoor unit on a window frame

- (1) Determine the positions of the wooden uprights to be attached to the window frame.
- (2) Attach the wooden uprights to the window frame giving attention to the weight of the indoor unit.
- (3) Attach the installation plate to the wooden upright using tapping screws.

If you fix the indoor unit on a gypsum board

- (1) Use stud finder to find out locations of the studs.
- (2) Fix the plate hanger on two studs.



- Search for other spots if there are less than two studs, or the distance between the studs are different from the plate hanger.
- Fix the installation plate without inclining to one side.



- Make sure that a wall can withstand the weight of the product. If you install the product in a place where it is not strong enough to withstand the product weight, the unit could fall and cause injury.





Disassembling/Assembling the Cover panel for indoor unit installation



Please scan this QR code for detail video of indoor unit installation.

In order to install the indoor unit, you must disassemble the cover panel first. Please proceed following instructions to disassemble and assemble the cover panel. Hooks (on the cover panel) may get damaged if you apply excessive force as you disassemble and assemble the cover panel. Please follow the following instructions.

Removing the screws

Cover panel is assembled on the bottom part of the indoor unit (as shown in the illustration) and it is fastened with screws. Remove the Cap screw first and unfasten the screws so that you can disassemble the cover panel.

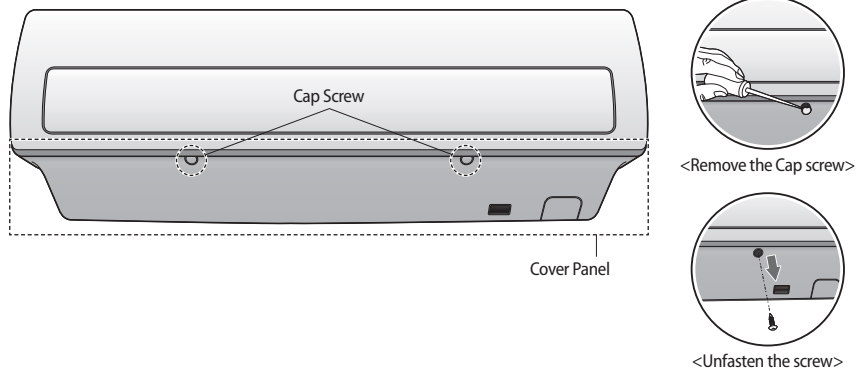

Removing the Cover panel (Before mounting the indoor unit)

Cover panel is fixed to a main body of the product with hooks on two sides and central part as shown in the illustration. Release the hooks on the sides first, and then release the hooks on the central part. Check the location of the hooks before removing the cover panel.

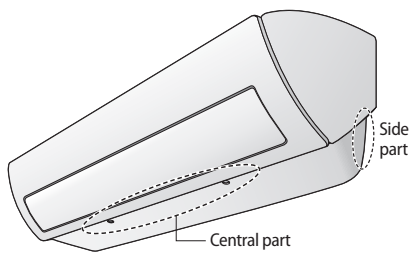

► Location of the hooks on the central part

Number and location of the hooks	
Hook	

* For specific Hook location and quantity, please refer to cover panel with indicating arrows based on physical goods.



Disassembling/Assembling the Cover panel for indoor unit installation

▶ Removing the hooks on the side

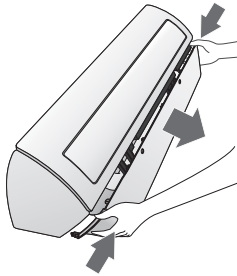

- * Caution (fragile)
- Gently press the both side of the cover panel inwards () and release the hooks on both sides().

▶ Removing the hooks on the central part

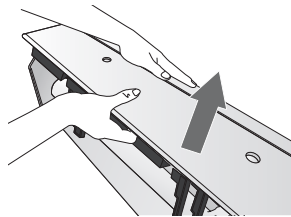

- * Caution (fragile)
- Use both hands
- Release each hook by pushing it up at an angle.

Assembling the Cover panel (After mounting the indoor unit)

To assemble the Cover panel, proceed in reverse order of disassembling.

Use both hands for assembling and be extra careful not to damage the pipes and drain hose.

Fix the hooks on the side and central part. Then fasten the screws and assemble the Cap screws.

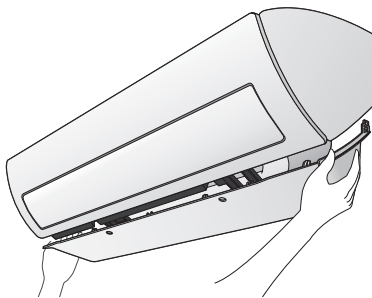

<Fix the hooks on side parts>



<Fix the hooks on central part>



<Fasten the screw>

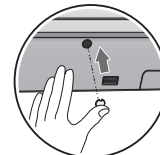

<Assemble the Cap screw>



Connecting the assembly cable

Cable specification

Model	Power cable (Outdoor Unit)	Interconnection cable (Indoor-Outdoor)		Type GL
		Power Supply	3 x 1.0 mm ² , H07RN-F (60245 IEC66)	
09/12 **18/24** **30**	3G, 1.0 mm ² , H07RN-F(**09/12**) 3G, 2.5 mm ² , H07RN-F(**18/24**) 3G, 4.0 mm ² , H07RN-F(**30**)	F1/F2 communication	2 x 0.75 mm ² , H05RN-F (60245 IEC57)	10 A (**09/12**) 20 A (**18/24**) 25 A (**30**)
		DRED Connected Wire	-	



NOTE

- Connect the power cable to the auxiliary circuit breaker. If every pole fails to connect to the power supply, it must be incorporated in a wire with a contact opening of ≥ 3 mm.
- Use shield cable (Category 5; less than 50pF/m) for noisy environmental site.

Connecting the cable

Electrical work

- (1) For electrical and earth works, comply with the 'technical standards of electrical installations' and the 'wiring regulations' of the Local wiring regulations.
- (2) Tighten the terminal block screw to under 1.2 N·m (12 kgf·cm).
- (3) Precautions when connecting terminal blocks of the indoor unit

- ▶ Before connecting, make sure the connecting part of the terminal socket is facing upwards.

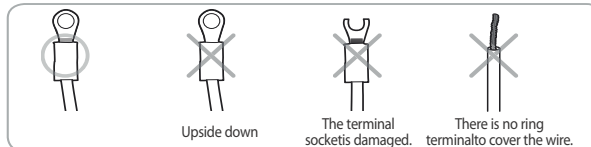

- ▶ There must be no space between the terminal and the screw when connected.
- Any remaining space may become a fire hazard due to overheating of the electrical contact.

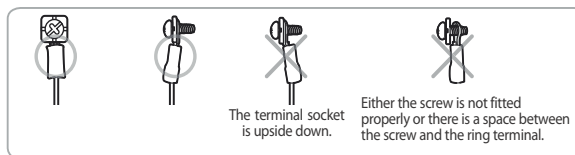

CAUTION

- For the terminal block wiring, use a wire with a ring terminal socket only. Regular wires without a ring terminal socket may become a fire hazard due to overheating of the electrical contact during a wiring work.

Connecting the assembly cable

※ When you install the unit, make first refrigerant connections and then electrical connections.
Connect the air conditioner to grounding system before performing the electrical connection.
If unit is uninstalled, first disconnect electrical cables, then refrigerant connections.

If the outdoor unit is more than 7.5 meters away from the indoor unit, you must extend the cable. The maximum length of the cable is 15(**09/12**) / 30(**18/24/30**) meters.

1. Extend the assembly cable if necessary.



- Do not connect two or more different cables to extend the length. It may cause fire.

2. Open the cover panel.

3. Remove the screw securing the connector cover.

4. Pass the assembly cable through the rear of the indoor unit and connect the assembly cable to terminals. (Refer to the picture below)



- Each wire is labeled with the corresponding terminal number.

5. Pass the other end of the cable through the 65 mm hole in the wall.

6. Close the connector cover by tightening the screw carefully.

7. Close the cover panel.

8. Remove the terminal board cover on the side of the outdoor unit.

9. Connect the cables to the terminals as seen in the picture.



- Each wire is labeled with the corresponding terminal number.
- DRED(Demand Response Enabling Device) may be supplied by the power supply utility.

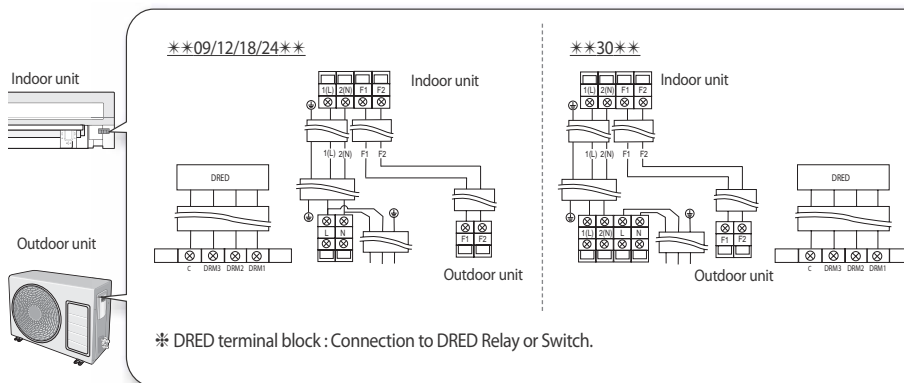

- Also circular terminal must be matched with screw size in terminal block.
- After connecting the cables, make sure terminal numbers on the indoor/outdoor unit matches.
- Please ensure that Power & Communication cables are separated, they must not be in the same cable.
- Do not connect 240 V direct to DRED's or F1/F2 terminal blocks.



10. Connect the grounding conductor to the grounding terminals.

11. Close the terminal board cover by tightening the screw carefully.



- In Russia and Europe, consult with the supply authority to determine the supply system impedance before installation.



- Connect the wires firmly so that wires can not be pulled out easily. (If they are loose, it could cause burn-out of the wires.)
- Connect the wires according to color codes, referring to the wiring diagram.
- The power cable and the interconnection cable should be selected according to the specification in page 41.

DRED wiring diagram

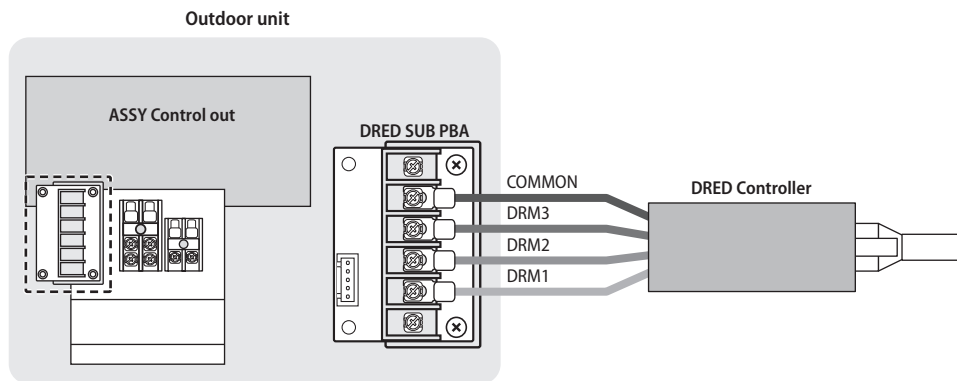



Installing and connecting the assembly pipe of the indoor unit

Connect indoor and outdoor units with field-supplied copper pipes by means of flare connections. Use insulated seamless refrigeration grade pipe only, (Cu DHP type according to ISO1337), degreased and deoxidized, suitable for operating pressures of at least 4200 kPa and for burst pressure of at least 20700 kPa. Under no circumstances must sanitary type copper pipe be used.

There are 2 refrigerant pipes of different diameters:

- The smaller one is for the liquid refrigerant
- The larger one is for the gas refrigerant

A short pipe is already fitted to the air conditioner. You may need to extend the pipe using the assembly pipe (optional).

The connection procedure for the refrigerant pipe varies according to the exit position of the pipe when facing the wall:

- Right(A)
- Left(B)
- Underside(C)
- Rear

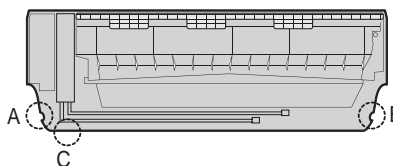

1. Cut out the appropriate knock-out piece (A, B, C) on the rear of the indoor unit unless you connect the pipe directly from the rear.
2. Smooth the cut edges.
3. Remove the protection caps of the pipes and connect the assembly pipe to each pipe. Tighten the nuts first with your hands, and then with a torque wrench, applying the following torque:

Outer Diameter	Torque	
	N·m	kgf·cm
ø6.35 mm	14~18	140~180
ø9.52 mm	34~42	350~430
ø12.70 mm	49~61	500~620
ø15.88 mm	68~82	690~830



- If you want to shorten or extend the pipes, refer to page 45~46.

4. Cut off the remaining foam insulation.
5. If necessary, bend the pipe to fit along the bottom of the indoor unit. Then pull it out through the appropriate hole.
 - ▶ The pipe should not project from the rear of the indoor unit.
 - ▶ The bending radius should be 100 mm or more.
6. Pass the pipe through the hole in the wall.
7. For further details on how to connect to the outdoor unit and evacuate the air, refer to page 49~51.



- The pipe will be insulated and fixed permanently into position after finishing the installation and the gas leak test; refer to page 53 for further details.



- Tighten the flare nut with torque wrench according to specified method. If the flare nut is over-tightened, the flare may break and cause refrigerant gas leakage.
- DO NOT WALL UP THE PIPE CONNECTION!
All refrigerant pipe connection must be easy accessible and serviceable.



Assembling the hanger screw and guide

1. Cut out the knock-out piece according to the drain hose direction before fixing the indoor unit.
 2. Fix the indoor unit on the wall.
Pass the cables, pipes and hose through the hole which would be connected to the outdoor unit.
 3. Use 2 screws to fix the indoor unit as shown in the picture.
 4. Assemble the Guide into the position where the knock-out piece has been cut out before.
There're three hooks on the Guide, they must be totally fixed to the unit.
- * The method of assembling the Guide is same whether it's on right or on left.

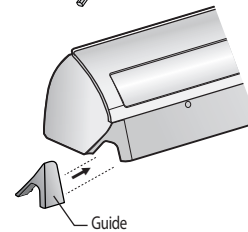
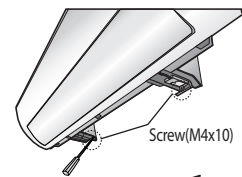
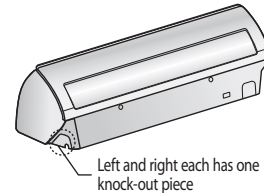

Evacuating the indoor unit

The indoor unit is supplied with inert gas (nitrogen).
Before installing the unit, check if nitrogen gas flow out of indoor unit.
If this one isn't true, DO NOT INSTALL THE UNIT since leakage could be inside the indoor unit.

1. Unscrew the caps at the end of each pipe.
- ▶ All inert gas exhausts from the indoor unit.



To prevent dirt or foreign substances from getting into the pipes during installation, do NOT remove the caps completely until you are ready to connect the pipes.



The remaining air in the Refrigeration cycle, which contains moisture, may cause malfunction on the compressor.
Always contact the service center or a professional installation agency for product installation.

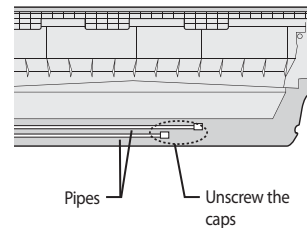

Cutting or extending the pipe

The length of the pipe can be:

- Extended up to : see table page 34
- Shorten up to: see page 34



If you need a pipe longer than 7.5 meters:
• You must add refrigerant to the pipes; otherwise, the indoor unit may freeze.



Cutting or extending the pipe

1. Make sure that you have all the required tools (pipe cutter, reamer, flaring tool and pipe holder).
2. If you want to shorten the pipe, cut it using a pipe cutter, ensuring that the cut edge remains at 90° with the side of the pipe (see below examples of correct and incorrect cut edges).

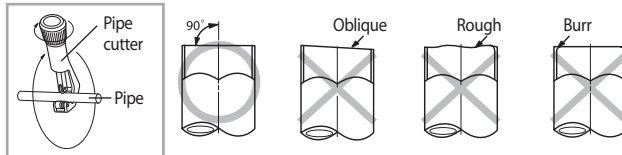

3. To prevent a gas leak, remove all burrs at the cut edge of the pipe using a reamer.



• Face the pipe down while removing the burrs to make sure that burrs do not get in to the pipe.

4. Put a flare nut slightly into the pipe and modify the flare.

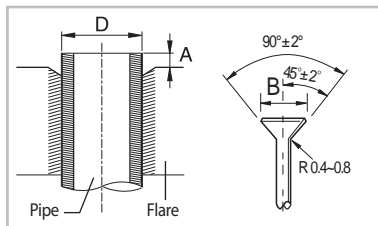

Outer Diameter (D)	Depth (A)	Flaring Size (B)
ø6.35 mm	1.3 mm	8.7 - 9.1 mm
ø9.52 mm	1.8 mm	12.8 - 13.2 mm
ø12.70 mm	2.0 mm	16.2 - 16.6 mm
ø15.88 mm	2.2 mm	19.3 - 19.7 mm

5. Check if you flared the pipe correctly (see examples of incorrectly flared pipes below).



6. Align the pipes to connect them easily. Tighten the flare nuts first with your hands, and then with a torque wrench, applying the following torque:

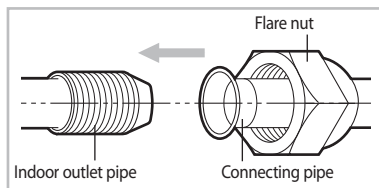

Outer Diameter	Torque	
	N·m	kgf·cm
ø6.35 mm	14~18	140~180
ø9.52 mm	34~42	350~430
ø12.70 mm	49~61	500~620
ø15.88 mm	68~82	690~830



• Excessive torque can be cause of gas leakage. If extending pipe by welding/brazing please ensure nitrogen is used during welding/brazing process. The joint must be accessible and serviceable.

7. For further details on how to connect to the outdoor unit and evacuate the air, refer to page 49~51.



• Tighten the flare nut with torque wrench according to specified method.
If the flare nut is over-tightened, the flare may break and cause refrigerant gas leakage.





Installing and connecting the drain hose of the indoor unit

When installing the drain hose for the indoor unit, check if condensation draining is adequate.
When passing the drain hose through the 65 mm hole drilled in the wall, check the followings:

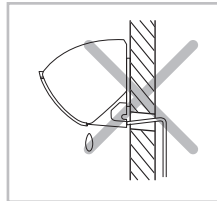
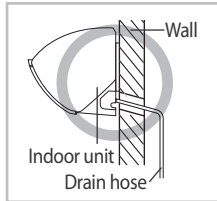

The drain hose must NOT slant upwards.

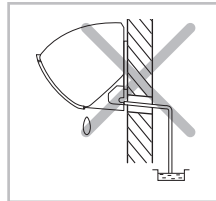

The end of the drain hose must NOT be placed under water.

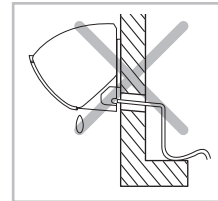

The drain hose must not be bent.

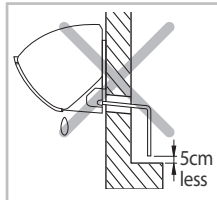

Keep a clearance of at least 5 cm between the end of the drain hose and the ground.

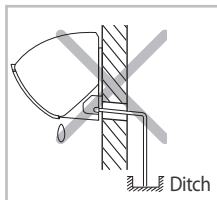

Do not place the end of the drain hose in a hollow.

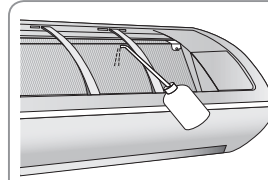

After completing the installation of the drain hose, pour water into the drain pan to check whether the hose is well drained.



Drain hose installation

1. If necessary, connect the 2 meter extension drain hose to the drain hose.
2. If you use the extension drain hose, insulate the inside of the extension drain hose with a shield.
3. Fit the drain hose into 1 of 2 drain hose holes, then fix the end of the drain hose tightly with a clamp.



If you do not use the other drain hose hole, block it with a rubber stopper.

4. When extending the Drain Hose, hold the end of Drain Hose and Extended Hose, rotate and insert the drain hose into Extended hose for 40~45 mm. Make sure the two hoses are firmly connected, there is no water leakage.
5. Connect the Drain Hose after using Foam Insulation to wrap the Extended Hose. Then, Use vinyl tape to wrap the each side of connection by 20 mm.

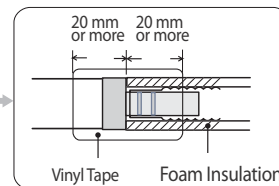
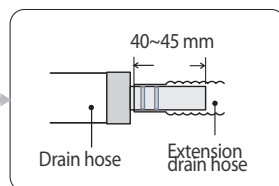
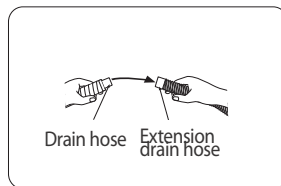
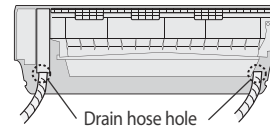



Installing and connecting the drain hose of the indoor unit

6. Pass the drain hose under the refrigerant pipe, keeping the drain hose tight.
7. Pass the drain hose through the hole in the wall. Check if it slants downwards as seen in the picture.
8. Using natural drainage method, check the drainage is normal.

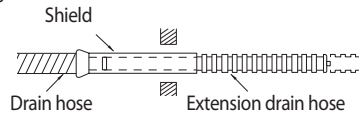

The hose will be fixed permanently into position after finishing the installation and the gas leak test; refer to page 53 for further details.



- Make sure the installed direction of the drain hose is correct. Inadequate installation may cause condensate water leakage.
- If the drain hose is routed inside the room, insulate the hose so that dripping condensation does not damage the furniture or floors.
- **DO NOT WALL UP THE DRAIN HOSE CONNECTION!**
Drain hose connection must be easy accessible and serviceable.

Changing direction of the drain hose

Change the direction only when it is necessary.

1. Detach the rubber cap with the pliers.
2. Detach the drain hose by pulling it and turning to the left.
3. Insert the drain hose by fixing it with the screw into the groove of the drain hose and the outlet of the drain pan.
4. Attach the rubber cap with a screwdriver by turning it to the right until it fixes to the end of the groove.
5. Check for leakage on both side of the drain outlet.

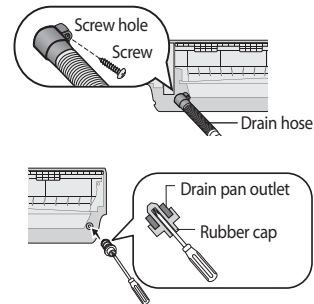

Pour the water in direction of arrow. ※ Direction of the drained water

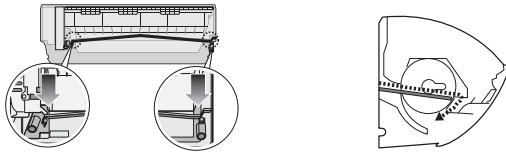

- Make sure the indoor unit is in upright position when you pour water to check for leakage. Make sure that the water does not overflow onto the electrical part.



Installing and connecting the drain hose of the outdoor unit

While heating, ice may accumulate. During the process of defrosting, check if condensation draining is adequate. For adequate draining, do the following.

1. Insert the drain plug into the drain hole on the underside of the outdoor unit.



- To avoid drain plug from contacting the ground, secure gap between the ground and the bottom surface of the outdoor unit.

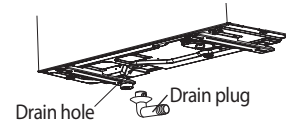

2. Connect a drain hose to the drain plug.

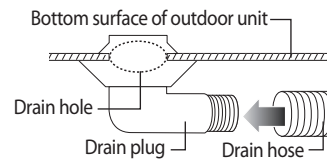

3. Ensure that condensation draining is adequate.



- In areas with heavy snow fall, piled snow could block the air intake. To avoid this incident, install a frame that is higher than estimated snow fall. In addition, install a snow-proof hood to avoid snow from piling on the outdoor unit.

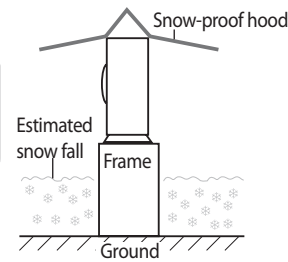

Evacuating the connected pipes

The outdoor unit is loaded with sufficient R-410A refrigerant. Do not vent R-410A into atmosphere: it is a fluorinated greenhouse gas, covered by Kyoto Protocol, with a Global Warming Potential (GWP) = 1975.

You should evacuate the air in the indoor unit and in the pipe. If air remains in the refrigerant pipes, it affects the compressor. It may cause reduction of cooling capacity and malfunction. Use Vacuum Pump as seen in the picture.



- When installing, make sure there is no leakage. When recovering the refrigerant, ground the compressor first before removing the connection pipe. If the refrigerant pipe is not properly connected and the compressor works with the service valve open, the pipe inhales the air and it makes the pressure inside of the refrigerant cycle abnormally high. It may cause explosion and injury.

Evacuating the connected pipes

1. Connect each assembly pipe to the appropriate valve on the outdoor unit and tighten the flare nut.
2. Tighten the flare nut first with your hands, and then with a torque wrench, applying the following torque.

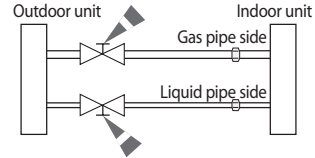

• Excessive torque can be cause of gas leakage.



• Make the electrical connection and leave the system into "stand by mode". Do not turn on the system!
This is necessary for better vacuum operation (full OPEN position of Electronic Expansion Valve - EEV -).

Outer Diameter	Torque	
	N·m	kgf·cm
ø6.35 mm	14~18	140~180
ø9.52 mm	34~42	350~430
ø12.70 mm	49~61	500~620
ø15.88 mm	68~82	690~830

3. Connect the charging hose of the low-pressure side of manifold gauge to a gas service port as seen in the picture.
4. Open the valve of the low pressure side of manifold gauge counterclockwise.
5. Evacuate the air in the connected pipes using the vacuum pump for about 15 minutes.
 - ▶ Make sure that pressure gauge shows -0.1 MPa(-76 cmHg) after about 10 minutes.
This procedure is very important to avoid a gas leak.
 - ▶ Close the valve of the low pressure side of manifold gauge clockwise.
 - ▶ Turn off the vacuum pump.
 - ▶ Check for 2 minutes if there is any pressure change.
 - ▶ Remove the hose of the low pressure side of manifold gauge.
6. Set a valve cork of liquid and gas service port to the open position.

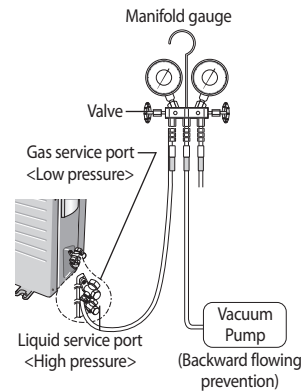

Adding Refrigerant

Add refrigerant charge according to table below:

If you use a pipe longer than 7.5 m,
'A' g of refrigerant R-410A must be added for each extra meter.

If you use a pipe shorter than 7.5 m,
The evacuating time is normal.

Refer to the Service Manual for further details.

Model	A
09/12	15
18/24	15
30	40



• The remaining air in the Refrigeration cycle, which contains moisture, may cause malfunction on the compressor.
• Always contact the service center or a professional installation agency for product installation.



Important information regulation regarding the refrigerant used

This product contains fluorinated greenhouse gases covered by the Kyoto Protocol.

Do not vent gases into the atmosphere.

Refrigerant type	GWP value
R-410A	1975

* GWP=Global Warming Potential

1. Please fill in with indelible ink,

- ▶ ① the factory refrigerant charge of the product,
- ▶ ② the additional refrigerant amount charged in the field and
- ▶ ①+② the total refrigerant charge. on the refrigerant charge label supplied with the product.



- a. Factory refrigerant charge of the product: see unit name plate
- b. Additional refrigerant amount charged in the field (Refer to the above information for the quantity of refrigerant replenishment.)
- c. Total refrigerant charge
- d. Refrigerant cylinder and manifold for charging

Contains fluorinated greenhouse gases covered by the Kyoto Protocol.

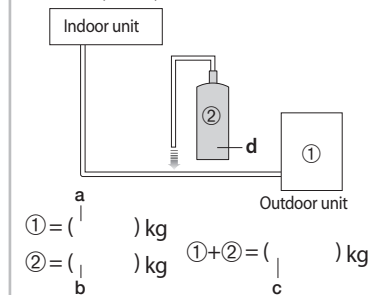

- The filled-out label must be adhered in the proximity of the product charging port (e.g. onto the inside of the stop valve cover).

Charging the refrigerant under conditions of liquid by using a liquid pipe

R-410A is a mixed type of refrigerant. It is necessary for recharging under conditions of liquid. When recharging refrigerant from the refrigerant cylinder to the equipment, follow the instructions below.

1. Before recharging, check whether the cylinder has a siphon or not. There are two ways to recharge the refrigerant.

Cylinder with siphon

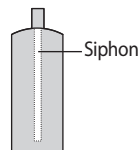

- ▶ Charge the refrigerant standing the cylinder upright.

Cylinder without siphon



- ▶ Charge the refrigerant turning the cylinder upside down.



- If R-410A refrigerant is charged with gas, the composition of the charged refrigerant changes and the characteristics of the equipment vary.
- During the measuring operation of refrigerant quantity added use electronic scales. If cylinder doesn't have syphon, upset it.



Performing the gas leak tests

Make sure to check for gas leaks before completing the installation process (connecting the assembly pipe and hose between indoor unit and outdoor unit, insulating the cables, hose and pipe, and fixing the indoor unit to the installation plate).

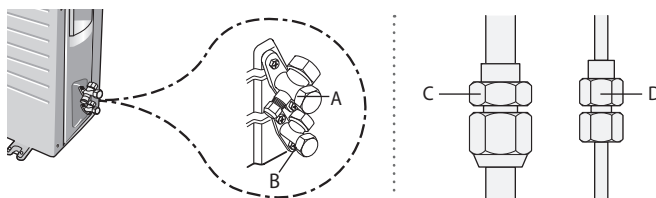

Test part for outdoor unit

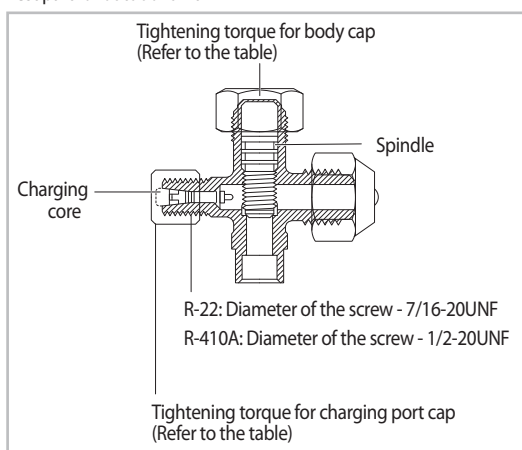

Test part for indoor unit

- ▶ Before inspecting the leakage, use a torque wrench to close the cap for the service valve. (Comply with a tightening torque for each size of the diameter, and tighten the cap firmly to prevent any leakage.)
- ▶ To check for any possible leakage, insert inert gas into the pipes connected to indoor/outdoor units and check the connection part of the indoor/outdoor units with soap lather or liquid for leakage test.

Outer Diameter (mm)	Tightening torque	
	Body cap (N·m)	Charging port cap (N·m)
ø 6.35	20 ~ 25	10 ~ 12
ø 9.52	20 ~ 25	
ø 12.70	25 ~ 30	
ø 15.88	30 ~ 35	
ø 19.05	35 ~ 40	

(1 N·m = 10 kgf·cm)

To check for gas leaks on the outdoor unit,
Check the valve A and B using a leak detector.

To check for gas leaks on the indoor unit,
Check the flare nut C and D using a leak detector.

Leak test with nitrogen (before opening valves)

In order to detect basic refrigerant leaks, before recreating the vacuum and recirculating the R-410A, it's responsible of installer to pressurize the whole system with nitrogen (using a cylinder with pressure reducer) at a pressure above 40 bar (gauge).

Leak test with R-410A (after opening valves)

Before opening valves, discharge all the nitrogen from the system and create vacuum according to page 49~51. After opening valves, check leaks using a leak detector for refrigerant.

Pump down (before disconnecting the refrigerant connections for unit repair, removal or disposal)

Pump-down is an operation intended to collect all the system refrigerant in the outdoor unit.

This operation must be carried out before disconnecting the refrigerant tubing in order to avoid refrigerant loss to the atmosphere.

- ▶ Shut off the liquid valve with the Allen wrench.
- ▶ Turn the system on in cooling with fan operating at high velocity.
(Compressor will immediately start, provided 3 minutes have elapsed since the last stop).
- ▶ After 2 minutes of operation, shut the suction valve with the same wrench.
- ▶ Turn the system off and switch mains supply off.
- ▶ Disconnect tubing. After disconnection, protect valves and tubing ends from dust.
- ▶ Compressor damage may occur if run at a negative suction pressure.

English-52





Fixing the indoor unit in place

Perform the following work on the area where gas leak test was done priory.
After checking for gas leaks in the system, insulate the pipe, hose and cables.
Then place the indoor unit on the installation plate.

1. To minimise condensation problems, wrap foam insulation (as shown in the figure) on a part without insulation on the end of the pipes.
2. Wind the pipe, assembly cable and drain hose with vinyl tape.
3. Place the bundle (the pipe, assembly cable and drain hose) in the lower part of the indoor unit carefully so it does not project from the rear of the indoor unit.
4. Hook the indoor unit to the installation plate and move the unit to the right and left until it is securely in place.



• Make sure pipe does not move when you install the indoor unit on an installation plate.

5. Wrap the rest of the pipe with vinyl tape.
6. Attach the pipe to the wall using clamps (optional).

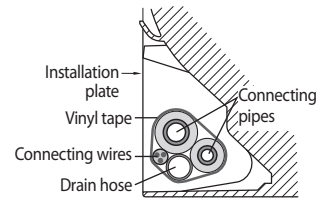
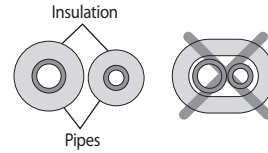

05 INSTALLATION

Fixing the outdoor unit in place

Install the outdoor unit in level on a stable base to help avoid the generation of noise and vibration, especially when installing the unit close to a neighbor.
If you install the outdoor unit in a place exposed to strong winds or at a height, fix it to an appropriate support (wall or ground).

1. Place the outdoor unit as indicated on the top of the unit to let the discharged air out properly.
2. Fix the outdoor unit in level to an appropriate support using anchor bolts.
3. If the outdoor unit is exposed to strong winds, install shield plates around the outdoor unit so that the fan can operate correctly.



• Secure the rubber leg to help prevent the generation of noise and vibration.

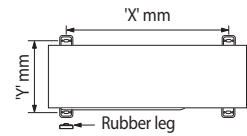

Model	X	Y
AR09/12**CWK	602	310
AR09/12**DUR	602	310
AR09/12**BWK	612	317
AR09/12**CUR	612	317
18/24	660	340
30	690	403

Outdoor unit installed on the wall by rack

- Ensure the wall will be able to suspend the weight of rack and outdoor unit;
- Install the rack close to the column as much as possible;
- Install proper grommet in order to help reduce noise and residual vibration transferred by outdoor unit towards wall.

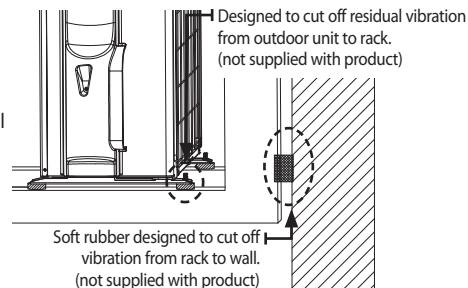

English-53





Smart Install mode

This model supports Smart Install mode which checks installation status to find out if there is any problems with any of the functions. Execute Smart Install mode after installation.

1. Check the installation status of the air conditioner.
 - 1) Check the power supply, service valve (if it's open), power cable of the indoor and outdoor unit and amount of additional refrigerant required for pipe extension.
 - 2) Status of the indicator after supplying the power : Standby status
2. When the air conditioner is in standby status, use the remote controller to start the Smart Install mode.
 - 1) Press the [Set/Cancel or Cancel], [Mode], [Power] button simultaneously for 4 seconds.
 - ▶ Smart Install mode can be operated only with the supplied remote controller.
 - ▶ During the Smart install mode procedure, remote controller cannot be operated.

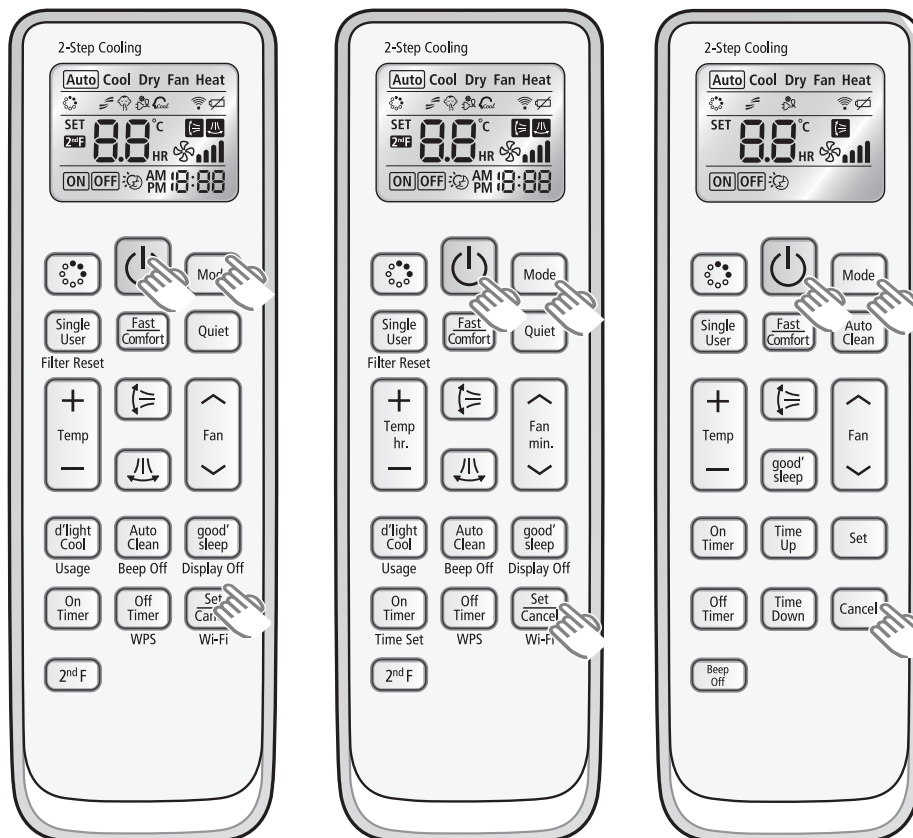

* Remote controller may be different (image/functions) depending on the model.





- 2) Smart Install mode in progress
- 88 Display : Progress will be displayed in 0~99.
 - LED Display : Indicator on the indoor unit display will blink in sequence and then all indicators will blink. (This will be repeated.)

TYPE	88 Display	LED Display
Indoor unit indicator		

* Display may be different depending on the model.

3. Smart Install mode will end.
- 1) Smart Install mode will take approximately 7~13 minutes. (Actual time may be different depending on the model.)
 - 2) When Installation is successful : Smart Install mode will end with ringing sound and the air conditioner will be in standby status. (Error message will not be displayed on the indoor unit indicator and the remote controller and buttons on the indoor unit will work normally.)
 - 3) When installation is not successful : Smart Install mode will end and error message will be displayed on the indoor unit display.



1. Take necessary measures when error occurs.
- Refer to the service manual for necessary measures for each error that occurs.
2. Use the product after taking care of the error that occurs.

88 Display	Error indicator			Error	Measures to take by an installer
	LED Display				
	LED 1	LED 2	LED 3		
E 12 1	○	●	○	Error on indoor temperature sensor	1. Check the connection of the connector
E 122, E 123	●	●	○	Error on indoor heat exchanger	1. Check the connection of the connector
E 154	○	○	●	Error on indoor fan motor	1. Check the connection of the connector 2. Remove foreign substance (Check for the cause that restrains motor)
88 display and all LED blinks	●	●	●	EEPROM/Option error	1. Re-set options
E 162, E 163					
E 422	●	○	●	EEV or Valve Close error-Self diagnosis (blockage error/ refrigerant leakage)	1. Check if the service valve is open 2. Check for refrigerant leakage (pipe connections, heat exchanger) and charge refrigerant if necessary 3. Check if there's any blockage on refrigerant cycle (indoor unit/outdoor unit) 4. Check if additional refrigerant has been added after pipe extension
E 554					

* ○: Off / ●: Blinking / ●: On



Final check and trial operation

To complete the installation, perform the following checks and tests to ensure that the air conditioner operates correctly.

Check the followings:

- Strength of the installation site
- Tightness of pipe connection to detect gas leak
- Electric wiring connection
- Heat-resistant insulation of the pipe
- Drainage
- Grounding conductor connection
- Correct operation (follow the steps below)

1. Press the **Power** button and check the following:

- ▶ The indicator on the indoor unit lights up.
- ▶ The airflow blade opens and the fan gears up for operation.

2. Press the **Mode** button to select **Cool** or **Heat** mode.

- ▶ In Cool mode, use **Temp hr.** + or – button and set the temperature at 16 °C.
- ▶ In Heat mode, use **Temp hr.** + or – button and set the temperature at 30 °C.



- Approximately 3~5 minutes later, outdoor unit will start to operate and the Cool or Warm air will blow out.
- After 12 minutes of stationary condition check the indoor unit air treatment.

Cooling mode (indoor unit check) → Inlet air temp. - Outlet air temp:
From 10 °C to 12 °C (indicative delta T)

Heating mode (indoor unit check) → Outlet air temp. - Inlet air temp:
From 11 °C to 14 °C (indicative delta T)

In heating mode, the indoor fan motor can remain off to avoid cold air blown into conditioned space.

3. Press the **Air swing** button and check the following:

- ▶ The airflow blades work properly.

4. Press the **Power** button to stop the operation.



- When you complete the installation successfully, hand over this manual to the user for storage in a handy and safe place.

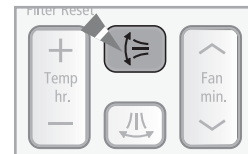
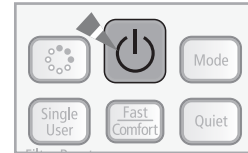

Pump down procedure (when removing the product)





1. Press the **Power** button on the indoor unit for 5 seconds. Beep will sound immediately to let you know that the product is ready for pump down procedure.
2. Release the valve caps on High and Low pressure side.
3. Use L wrench to close the valve on the high pressure side.
4. After approximately 2 minutes, close the valve on the low pressure side.
5. Stop operation of the air conditioner.
6. Disconnect the pipes.

English-56

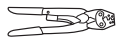

How to connect your extended power cables

Items to prepare
(compressor and insulation tape should be prepared by an installation technician.)

Tools	Crimping pliers	Connection sleeve (mm)	Insulation tape	Contraction tube (mm)
Spec	MH-14	20xØ7.0(HxOD)	Width 18 mm	50xØ8.0(LxOD)
Shape				

- As shown in the figure, peel off the shields from the rubber/wire of the power cable.
- Peel off 20 mm of the wire shields of the tube installed already.



• After peeling off the tube wire, you must insert a contraction tube.

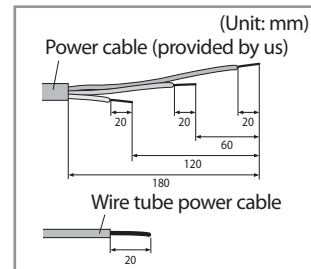

- Insert both sides of core wire of the power cable into the connection sleeve.

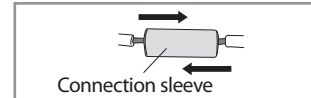

- Using a compressor, compress the two points and flip it over and compress another two points in the same location.
- The compression dimension should be 8.0.
- After compressing it, pull both sides of the wire to make sure it is firmly pressed.

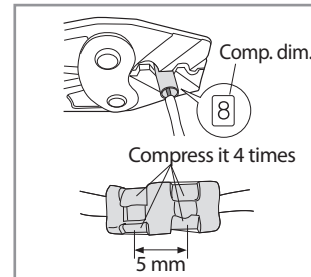

- Wrap it with the insulation tape twice and position your contraction tube in the middle of the insulation tape.
- Apply heat to the contraction tube to contract it.

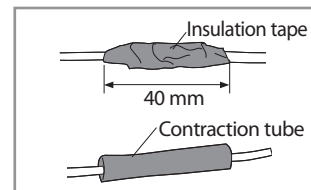

- After tube contraction work is completed, wrap it with the insulation tape to finish.

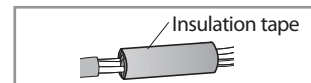

• In case of extending the electric wire, please DO NOT use a round-shaped pressing socket.
- Incomplete wire connections can cause electric shock or a fire.

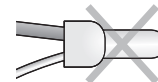



Memo



English-58





Memo



English-59





QUESTIONS OR COMMENTS?

COUNTRY	CALL	OR VISIT US ONLINE AT
AUSTRALIA	1300 362 603	www.samsung.com/au



DB68-03979A-03





AR**FS**WK** Series
AR**FS**UR** Series

Air Conditioner user & installation manual

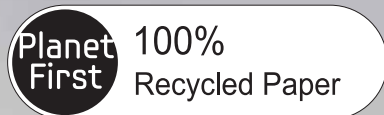

This manual is made with 100% recycled paper.

imagine the possibilities

Thank you for purchasing this Samsung product.
To receive more complete service, please
register your product at
www.samsung.com/register

